

# TRES



ES

tarifa de precios **2017**



**TRES**

[www.tresgriferia.com](http://www.tresgriferia.com)

# ÍNDICE DE CONTENIDOS

## tres exclusive

ESPACIO DUCHA / BAÑERA	SERIES	GRIFERÍA DE COCINA
Block System® <b>108</b>	Slim exclusive <b>21</b>	Monomando <b>96</b>
Shower Technology® <b>160</b>	Cuadro exclusive <b>39</b>	Con caño extraíble <b>99</b>
Mono-Term® <b>192</b>	Study exclusive <b>51</b>	Abatible <b>100</b>
Monomandos de 3 vías <b>202</b>	Loft colors <b>71</b>	Mural <b>100</b>
Programa de duchas <b>215</b>		

## tres selection

ESPACIO DUCHA / BAÑERA	SERIES	GRIFERÍA DE COCINA
Termostáticas <b>236</b>	Cuadro-tres <b>377</b>	Monomando <b>520</b>
Conjuntos Termostáticos <b>250</b>	Max-tres <b>395</b>	Con caño extraíble <b>528</b>
Monomandos <b>270</b>	Loft-tres <b>417</b>	Abatible <b>532</b>
Programa de duchas <b>293</b>	Class-tres <b>431</b>	Electrónica <b>533</b>
	Lex-tres <b>443</b>	Para tratamiento de agua <b>535</b>
	Alplus <b>457</b>	Industrial <b>536</b>
	Flat-tres <b>469</b>	Mural <b>538</b>
	K-tres <b>475</b>	Bimando <b>541</b>
	Bm-tres <b>483</b>	
	Monoclasic 1900 <b>489</b>	
	Clasic-tres <b>497</b>	
	Retro-tres <b>505</b>	
	Temporizadas / Electrónicas <b>545</b>	

## tres distribution

---

### SERIES

Monotres 2000	565
Eco-tres	571
Ese-23	579

### GRIFERÍA ESPECIAL

Bidé	558
Medicales	560
Peluquería	561
Cocina	561
Jardín-Piscina	562
Vino	563

### ACCESORIOS

Slim-tres	344
Cuadro-tres	345
Max-tres / Class-tres	346
Loft-tres	348
Retro-tres	350

### COMPLEMENTOS

Válvulas	354
Desagües	360
Sifones	362
Florones	365
Caños	365
Llaves de paso	368
Limitadores de caudal	373
Aireadores	374





Monomandos de 3 vías para ducha con jets de hidromasaje.



Monomandos de 3 vías para bañera.



Termostáticas electrónicas Shower technology® de 4 vías.



Termostáticas electrónicas Shower Technology® de 3 vías.



Mono-Term®, la tecnología de los monomandos del futuro.



Termostáticas empotradas Block System®.



Lavabos Loft-Tres de diferentes alturas y con caños más largos.



Grifería temporizada ideal para espacios públicos.



Duchas de mano con pulsador para escoger los tipos de chorro.



Grifería temporizada empotrada ideal para espacios públicos.





Cromoterapia con salida de agua Micro-Drop.



Rociadores INOX de gran formato.



Cocinas con acabado en Acero o Blanco-Mate.



Conjuntos termostáticos de superficie para bañera.





## Tradición

Desde su fundación en 1968, el espíritu industrial de Tres combina la ingeniería y calidad de los grandes inventos con la evolución de una empresa familiar.



## Fabricación

Todo el proceso de fabricación, desde la idea hasta el resultado final, se realiza en las propias instalaciones de Tres.



## Desarrollo

Ingeniería e investigación que revoluciona el mundo de la grifería y adapta los avances tecnológicos tanto a sus productos y patentes como a sus procesos de trabajo.

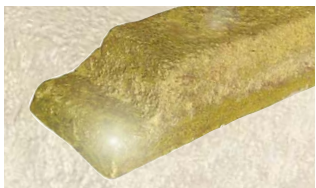

## Calidad

Productos fabricados con materiales garantizados, desde la materia prima como el latón hasta el baño de cromo. Con los procesos de control de calidad más exigentes.



## Diseño

La mayor variedad de productos y diseños para encontrar lo que mejor se adapta a cada estilo. Funcionalidad sin renunciar a la mejor decoración y confort.



## Exposición

Exposición permanente en el showroom TRES TRAINING CENTER para ver en pleno rendimiento el placer del agua y la tecnología de Tres.

Los productos TRES están fabricados íntegramente en España con materiales de primera calidad de origen europeo.

Los componentes y aleaciones de latón utilizados por TRES cumplen con las más estrictas normativas de seguridad, incluso la de UBA (Agencia federal alemana del medioambiente) norma DIN 50930 (EN 12164).



# DUCHAS PARA TODOS LOS GUSTOS

## Monomando

Con diseños adaptables y muchas posibilidades, es una opción simple y sumamente funcional para un gran placer en la ducha.

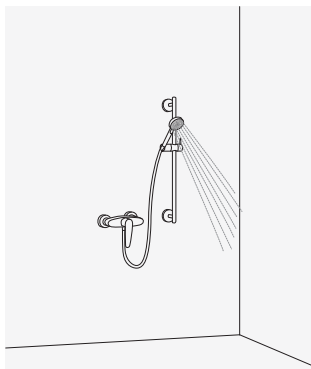

Conjuntos de superficie.

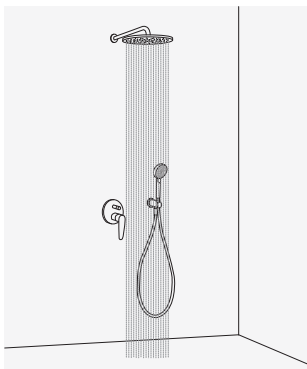

Conjuntos empotrados.

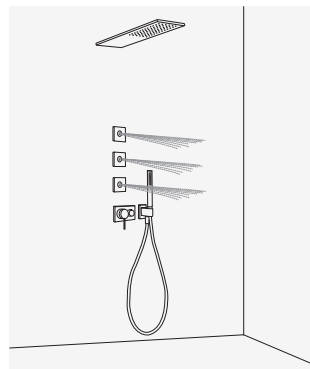

Conjuntos empotrados de 3 vías.

## Mono-Term®

La funcionalidad de los monomandos pero con un cartucho revolucionario que ofrece el confort similar de una termostática.

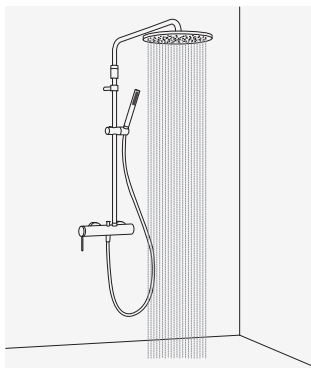

Conjuntos de superficie.

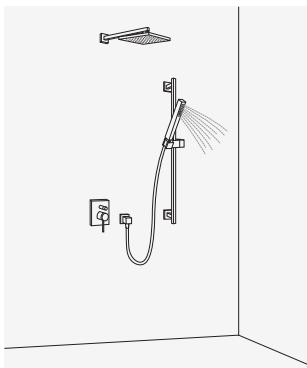

Conjuntos empotrados.

## Termostática

El control máximo de la temperatura y de la ducha. Las mayores prestaciones con distintos formatos, diseños y funcionalidades.

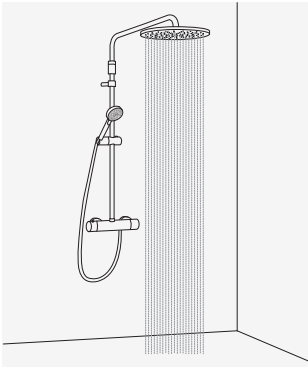

Termostáticas de superficie.

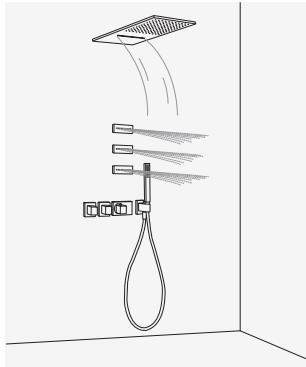

Conjuntos empotrados con varias funciones.

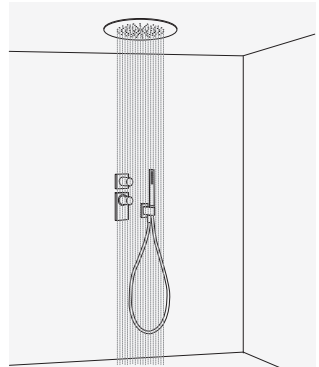

Conjuntos empotrados de techo.

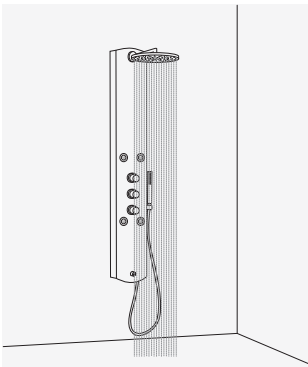

Columnas de ducha multifunciones.

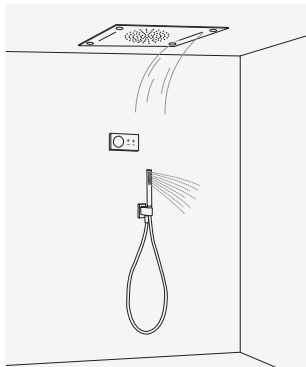

Conjuntos con panel digital electrónico.

# SISTEMAS PARA LA DUCHA MÁS EFICIENTE

## Monomando



Una solución sencilla y de fácil instalación con diferentes diseños y formas que se adaptan a cualquier espacio. Los monomandos destacan por su funcionalidad, un manejo cómodo desde un solo mando y alta resistencia al paso del tiempo.

*P* en Series y en las páginas 202 y 270.



## Mono-Term®



Mono-Term® es un sistema único y revolucionario ideado por Tres que marca el futuro en la fabricación de grifería. La funcionalidad es como la de los monomandos pero ofrece un confort similar a las de una termostática: mantiene la temperatura constante, bajo nivel acústico y seguridad.

*P* en la página 192.



## Termostáticas

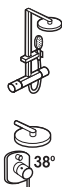

Control total de la temperatura, con cartuchos que garantizan un caudal de agua constante, con inversor integrado en el regulador de caudal y de diseños diversos con diferentes funciones y prestaciones.

*P* en Series y en la página 236.



## Block system®



Termostáticas empotradas de gran simplicidad y belleza, con control preciso de la temperatura e infinidad de combinaciones. Además, el sistema block system se caracteriza por su simplicidad en la instalación y alineación de los elementos.

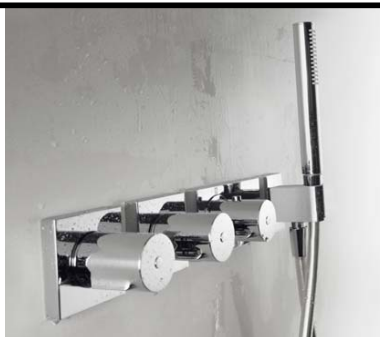

🔗 en Series Exclusive y en la página 108.

## Shower Technology®



A través del control electrónico digital se selecciona la temperatura y las diferentes salidas del agua de manera fácil e intuitiva para crear una experiencia única y personal. La centralita termostática se puede instalar en cualquier parte de la vivienda.



🔗 en Series Exclusive y en las páginas 160 y 248.

## Columnas de ducha



En un sólo sistema se integra el rociador, la ducha de mano y los jets de hidromasaje para aprovechar las máximas prestaciones de un producto termostático que ofrece la oportunidad de disfrutar del relax y el agua en estado puro.



🔗 en la página 266.

# LAVABOS FUNCIONALES Y CON PERSONALIDAD

## Escoja el modelo ideal

La altura y forma del lavamanos, así como el diseño del baño, influyen en la elección del grifo de lavabo ideal.

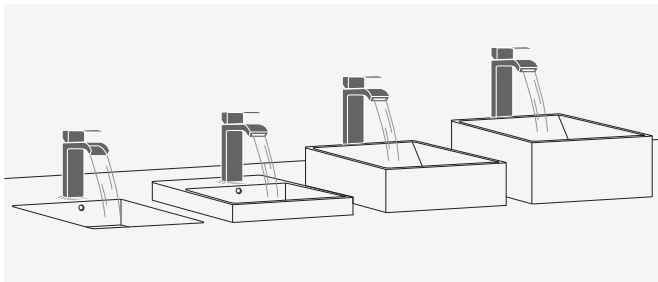

Grifos de lavabo convencionales para lavamanos de encimera o con cuerpos más altos para lavamanos de sobre encimera de distintas alturas.

Grifos de lavabo, monomandos o bimanos, con caños de diferente altura y distancia, ideales para encimeras especiales.

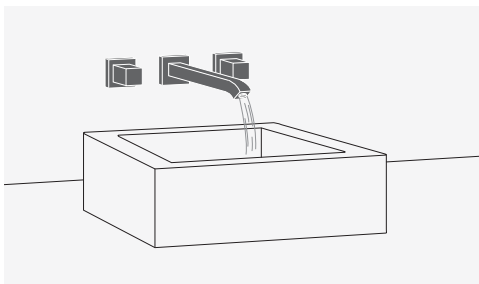
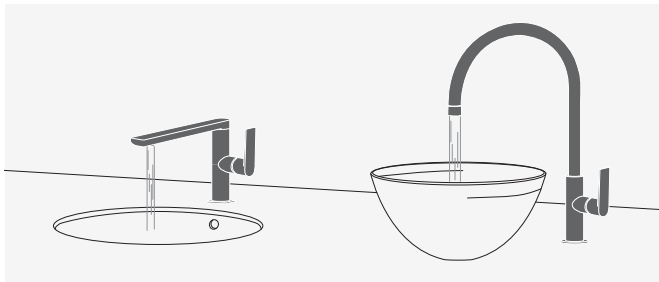

La grifería mural libera el espacio de la encimera, ofrece más longitud del caño y adaptabilidad en la altura.

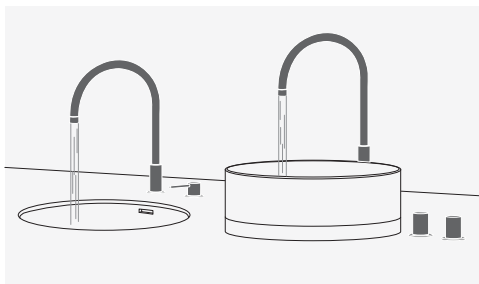

El mando de los grifos de repisa se instala por separado del caño, donde sea más cómodo para su uso. También con distintas alturas.



## Características generales



**Diseños para cada espacio**  
Gran variedad de modelos con estilos que se adaptan a cada ambiente.



**Discos cerámicos**  
Funcionamiento suave del mando con una larga vida útil del cartucho.



**Diversas alturas**  
Para elegir la mejor opción según la altura y forma de su lavamanos.



**Válvula SIMPLE-RAPID**  
Válvula con bloqueo superior.



**Distintas salidas de agua**  
Maneras distintas de dejar caer el agua, como una cascada o con aireador.



**Sistema antiquemaduras Protec-Tres®**  
Permite limitar la temperatura máxima deseada para la protección de niños y personas mayores.



**Cromado de gran resistencia**  
El cromado Tres-Micron® es duradero y fácil de limpiar.



**Ahorro de agua Tres-Duo®\***  
Dos posiciones de apertura de la maneta. En la posición intermedia se consume la mitad.

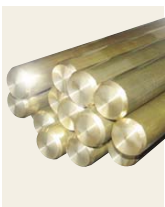

**Latón garantizado**  
Fabricado con latón de aleación CB755S, con bajo nivel de plomo, cumpliendo con la normativa Europea.

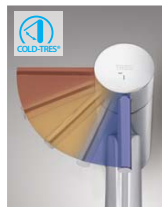

**Ahorro de energía Cold-Tres®\***  
El grifo se abre siempre con agua fría, evitando el encendido innecesario del calentador.

\* Los modelos con sistemas ecoeficientes se indican con el correspondiente símbolo.

**CUANDO LA COCINA ES UN PLACER**



## Cocinas para todos los usos



### Monomando

Con un cartucho de gran suavidad y un bajo nivel acústico que permite la apertura en agua fría.



### Bimando

El control con dos mandos o volantes independientes, uno para el agua fría y otro para la caliente.



### Abatible

Ideal para instalaciones frente a ventanas o armarios. El grifo rota y se tumba cuando es necesario.



### Caño extraíble

La ducha y el caño extraíbles permiten ampliar la zona de trabajo de 50 a 70 cm.



### Tratamiento de agua

Agua filtrada sin cloro en la cocina con un mismo caño y dos conducciones distintas. También para sistemas de osmosis.



### Grifería Mural

Combinan autenticidad, calidad y minimalismo en las formas, con distintas longitudes de caño.



### Grifería electrónica

Garantiza un mayor nivel de higiene, confort y seguridad. Ideal para hospitales, hoteles, restaurantes...









































### Industrial

Facilitan el trabajo en la cocina ya que incorporan una salida elevada y giratoria, garantizando la libertad de movimiento.

UN MUNDO DE INSPIRACIÓN A SU ALCANCE

www.tresgriferia.com



Slim exclusive			Cuadro-tres
Cuadro exclusive			Max-tres
Study exclusive			Loft-tres
Loft colors			Class-tres
Cocina exclusive			Lex-tres
Block system®			Alplus
Shower technology®			Flat-tres
Mono-term®			K-tres
Monomandos de 3/2 vías			Bm-tres
Programa de duchas exclusive			Monoclasic 1900
Termostáticas			Clasic-tres
Conjuntos termostáticos			Retro-Tres
Monomandos			Cocina selection
Programa de duchas selection			Temporizadas/Electrónicas
Accesorios			Grifería especial
Complementos			Monotres 2000
			Eco-tres
			Ese-23
			Listado de referencias





## SLIM EXCLUSIVE



Lavabos

**24**



Bidé

**28**



Monomandos de superficie

**28**



Monomandos empotrados

**29**



Bañeras de repisa

**33**



Termostáticas de superficie

**34**



Termostáticas empotradas

**36**



Termostáticas electrónicas empotradas

**37**



Accesorios

**344**



**RECAMBIOS**  
DE LOS ARTICULOS EN  
[www.tresgriferia.com](http://www.tresgriferia.com)

[www.tresgriferia.com](http://www.tresgriferia.com)







Monomando lavabo

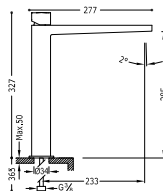
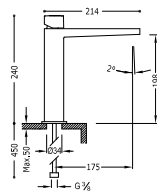
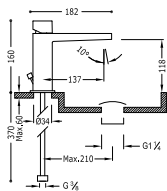

Monomando lavabo

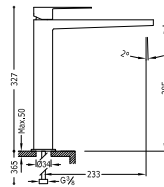
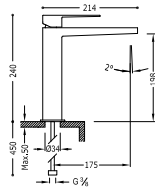
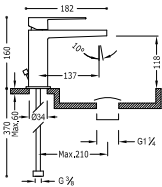

Monomando lavabo

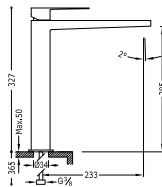
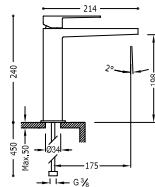
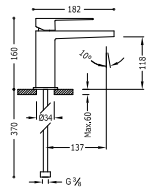
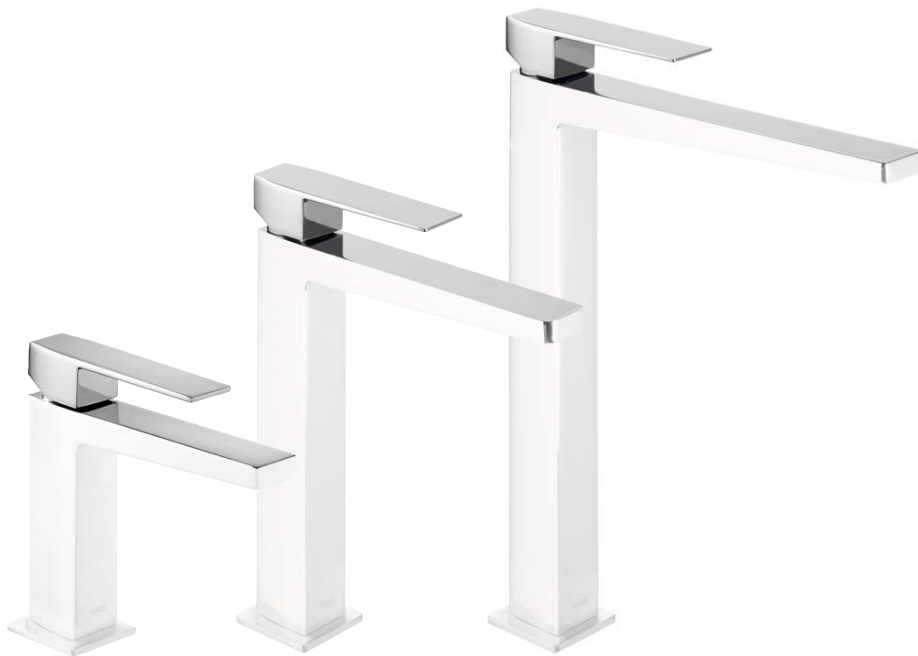

91.30.190	Ac	202.103.01.ACD
		202.103.01.NE.D
		202.103.01.BLD

91.30.190	Ac	202.103.03.ACD
		202.103.03.NE.D
		202.103.03.BLD

91.30.190	Ac	202.103.05.ACD
		202.103.05.NE.D
		202.103.05.BLD

Ref.:

**Monomando lavabo**

con caño cascada libre. **NOTA:** La grifería con caño cascada se acompaña con 2 llaves de regulación con filtro (Ref: 91.34.525).

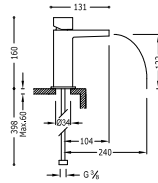

91.30.190  
Cr | **202.110.02**

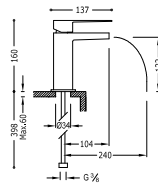

91.30.190  
Cr | **202.110.01**



**Monomando lavabo**

con caño cascada libre. **NOTA:** La grifería con caño cascada se acompaña con 2 llaves de regulación con filtro (Ref: 91.34.525).

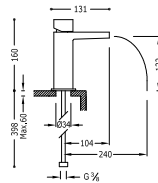

91.30.190  
■ **202.110.02.NE.D**  
■ **202.110.02.BL.D**

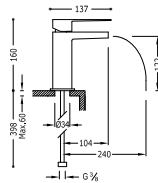

91.30.190  
■ **202.110.01.NE.D**  
■ **202.110.01.BL.D**



**Monomando mural**

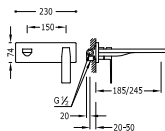

91.30.190 (185 mm.)  
Cr | **202.200.03**



91.30.190 (245 mm.)  
Cr | **202.200.04**  
Ac | **202.200.04.AC**



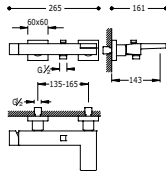

**Monomando bañera-ducha**

Ducha de mano anticalcárea (202.639.01) con soporte orientable y flexo SATIN (91.34.609).



91.30.190

Cr | **202.170.01** |

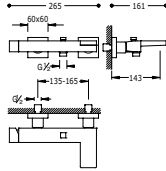

**Monomando bañera-ducha**

Ducha de mano anticalcárea con soporte orientable y flexo SATIN (91.34.609).



91.30.190

Ac | **202.170.01.AC** |

■ | **202.170.01.NE** |

■ | **202.170.01.BL** |

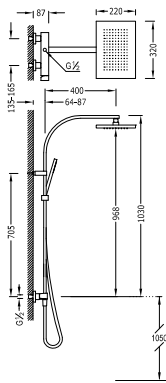

**Conjunto monomando ducha anticalcárea**

- Ducha fija 330x220 mm. con rótula. (299.632.02).  
- Ducha móvil anticalcárea (202.639.01).  
- Flexo SATIN (91.34.609.15).



91.30.190

Cr | **202.191.01** |

**MONOMANDOS EMPOTRADOS**

**Monomando empotrar (1 vía)**

cuerpo empotrado incluido

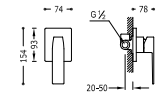

91.30.190

Cr | **202.177.02** |



91.30.190

Cr | **202.177.01** |

**Monomando empotrar (2 vías)**

cuerpo empotrado incluido

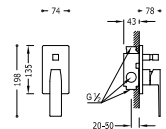

91.30.190

Cr | **202.180.02** |



91.30.190

Cr | **202.180.01** |



**Kit de ducha monomando empotrado**

- con cierre y regulación de caudal.
- Cuerpo empotrado incluido
- Soporte con toma pared (006.182.01).
- Ducha móvil anticalcárea (202.639.01).
- Flexo SATIN (91.34.609.15).

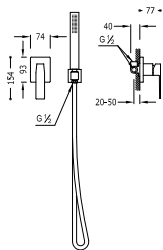

91.30.190

Cr 202.177.03 |



**Kit de ducha monomando empotrado**

- con cierre y regulación de caudal.
- Cuerpo empotrado incluido
- Ducha fija 320x220 mm. con rótula. Material Latón (299.632.02).
- Soporte con toma pared (006.182.01).
- Ducha móvil anticalcárea (202.639.01).
- Flexo SATIN (91.34.609.15).

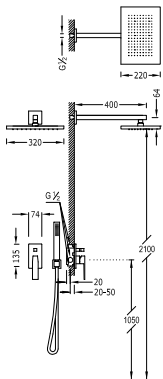

91.30.190

Cr 202.180.06 |



**Kit de ducha monomando empotrado**

- con cierre y regulación de caudal.
- Cuerpo empotrado incluido
- Ducha fija 320x220 mm. con rótula. Material Latón.
- Soporte con toma pared.
- Ducha móvil anticalcárea.
- Flexo SATIN (91.34.609.15).

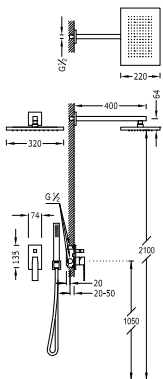

91.30.190

■ 202.180.06.NE |

■ 202.180.06.BL |



**N**

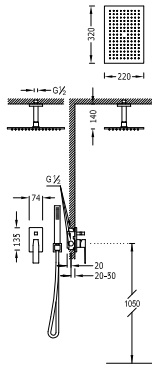

**Kit de ducha monomando empotrado**

con cierre y regulación de caudal.

- Cuerpo empotrado incluido
- Ducha fija 320x220 mm. con rótula. Material Latón (299.632.02).
- Soporte con toma pared (006.182.01).
- Ducha móvil anticalcárea (202.639.01).
- Flexo SATIN (91.34.609.15).



91.30.190

Cr | 202.180.80 |

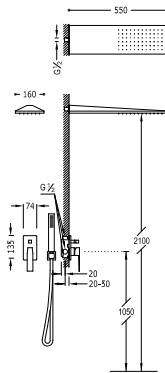

**Kit de ducha monomando empotrado**

con cierre y regulación de caudal.

- Cuerpo empotrado incluido
- Rociador ducha INOX a pared 160x550 mm. (299.903.03).
- Soporte con toma pared (006.182.01).
- Ducha móvil anticalcárea (202.639.01).
- Flexo SATIN (91.34.609.15).



91.30.190

Cr | 202.180.03 |

Ac | 202.180.03.AC |

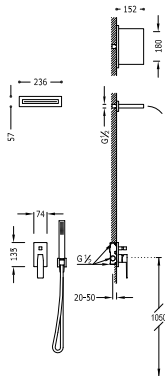

**Kit de ducha monomando empotrado**

con cierre y regulación de caudal.

- Cuerpo empotrado incluido
- Ducha INOX con cascada 152x200 mm.
- Soporte con toma pared (006.182.01).
- Ducha móvil anticalcárea (202.639.01).
- Flexo SATIN (91.34.609.15).



91.30.190

Cr | 202.180.05 |

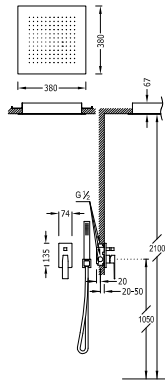

**Kit de ducha monomando empotrado**

con cierre y regulación de caudal.

- Cuerpo empotrado incluido
- Rociador ducha INOX a techo 380x380 mm. (1.34.944).
- Soporte con toma pared (006.182.01).
- Ducha móvil anticalcárea (202.639.01).
- Flexo SATIN (91.34.609.15).



Cr 202.980.01

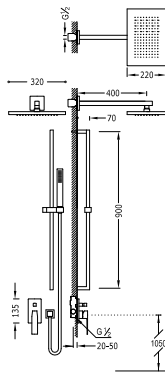

**Kit de ducha monomando empotrado**

con cierre y regulación de caudal.

- Cuerpo empotrado incluido
- Ducha fija 320x220 mm. con rótula. (299.632.02).
- Barra deslizante long. 900 mm. (1.34.520).
- Codo toma pared (006.182.01).
- Ducha móvil anticalcárea (202.639.01).
- Flexo SATIN (91.34.609.15).



Cr 202.180.07

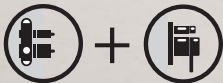

Como siempre, una sola referencia incorpora la parte empotrada y la parte vista listas para su instalación.



**Monomando bañera de repisa**

con ducha anticalcárea.

- Caudal: 3 bar – 13 l/m.

- NOTA: ver longitud caño.

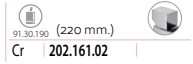
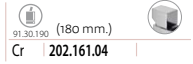
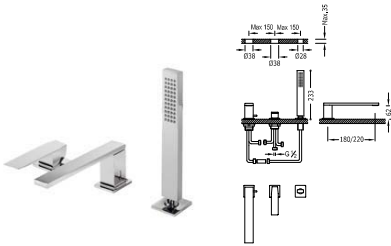

**Monomando bañera de repisa**

con caño cascada y ducha móvil anticalcárea (202.639.01).

- Caudal: 3 bar – 13 l/m.

- Compatible con el kit depósito ref: 202.245.01.

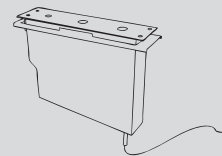
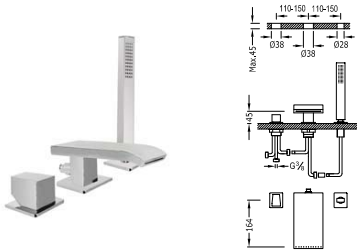

**KIT DEPÓSITO  
PARA BAÑERAS DE REPISA**

Fácil montaje superior. Sin registros.  
Sistema Patentado®

290

TERMOSTÁTICAS DE SUPERFICIE

Ref.:

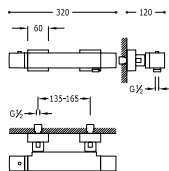

Ducha termostática

Ducha de mano anticálcaea (202.639.01) con soporte orientable y flexo SATIN (91.34.609.15).



91.06.161.10  
Cr 202.164.09

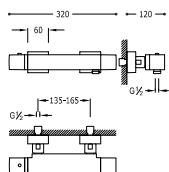

Ducha termostática

Ducha de mano anticálcaea con soporte orientable y flexo SATIN (91.34.609.15).



91.06.161.10  
Ac 202.164.09.AC  
■ 202.164.09.NE  
■ 202.164.09.BL

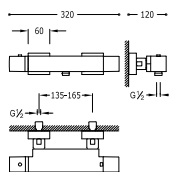

Bañera-ducha termostática

con cascada. Ducha de mano anticálcaea (202.639.01) con soporte orientable y flexo SATIN (91.34.609).



91.06.161.10  
Cr 202.174.09

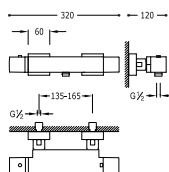

Bañera-ducha termostática

con cascada. Ducha de mano anticálcaea con soporte orientable y flexo SATIN (91.34.609).



91.06.161.10  
Ac 202.174.09.AC  
■ 202.174.09.NE  
■ 202.174.09.BL

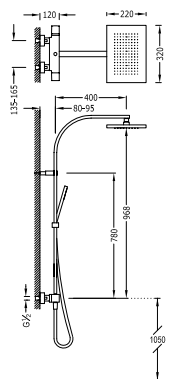

Conjunto ducha termostática

- Ducha fija 320x220 mm. con rótula. Material Latón (299.632.02).
- Ducha móvil anticálcaea (202.639.01)
- Flexo SATIN (91.34.609.15).
- Inversor integrado en el regulador de caudal.



91.06.161.10  
Cr 202.195.01

Ref: |

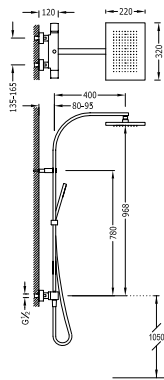

### Conjunto ducha termostática

- Ducha fija 320x220 mm. con rótula. Material Latón.
- Ducha móvil anticalcárea.
- Flexo SATIN (91.34.609.15).
- Inversor integrado en el regulador de caudal.



91.06.161.16

202.195.01.NE

202.195.01.BL

### Conjunto ducha termostática

- Ducha fija 320x220 mm. con rótula. Material Latón (299.632.02).
- Ducha móvil anticalcárea (202.639.01).
- Flexo SATIN (91.34.609.15).

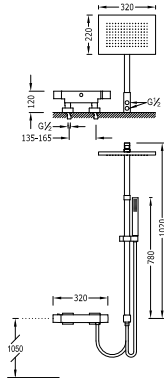

91.06.161.10

Cr | 202.385.01

### Conjunto bañera-ducha termostática

- Ducha fija 320x220 mm. con rótula. Material Latón (299.632.02).
- Ducha móvil anticalcárea (202.639.01).
- Flexo SATIN (91.34.609).
- Barra telescópica.

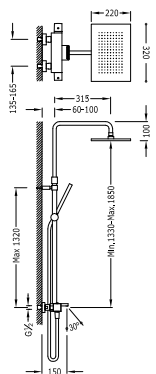

299.312.01

Cr | 202.312.01

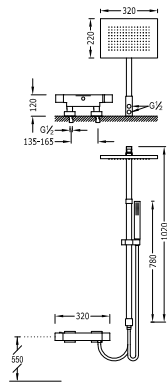

Conjunto bañera-ducha termostática

- Ducha fija 320x220 mm. con rótula. Material Latón (299.632.02).
- Ducha móvil anticalcárea (202.639.01).
- Flexo SATIN (91.34.609.15).



91.06.161.10

Cr 202.385.02

TERMOSTÁTICAS EMPOTRADAS

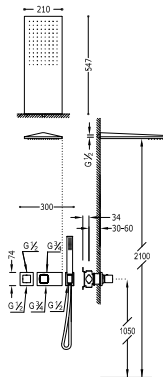

Kit de ducha termostático empotrado BLOCK SYSTEM

- con cierre y regulación de caudal (2 vías).
- Cuerpo empotrado termostático incluido.
- Rociador ducha INOX a pared 210x550 mm. (299.903.02).
- Ducha móvil anticalcárea (202.639.01).
- Flexo SATIN (91.34.609.15).



299.250.45

Cr 207.252.02

Ref: |



**Kit de ducha termostático empotrado BLOCK SYSTEM**

- con cierre y regulación de caudal (2 vías).
- Cuerpo empotrado termostático incluido
- Rociador ducha INOX a pared 210x550 mm.
- Ducha móvil anticálcarea.
- Flexo SATIN (91.34.609.15).

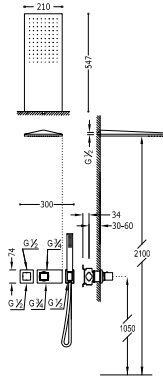

Ac	299.250.45.AC
Cr	299.250.45.NE
Bl	299.250.45.BL

Ac	207.252.02.AC
Cr	207.252.02.NE
Bl	207.252.02.BL



**TERMOSTÁTICAS ELECTRÓNICAS EMPOTRADAS**



**Kit electrónico de ducha termostático empotrado SHOWER TECHNOLOGY**

- Centralita termostática electrónica incluida (2 vías).
- Rociador ducha INOX a pared 210x550 mm. (299.903.02).
- Soporte con toma pared (207.182.01).
- Ducha móvil anticálcarea (202.639.01).
- Flexo SATIN (91.34.609.15).

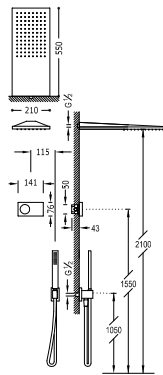

Cr | **092.865.51** |









## CUADRO EXCLUSIVE



Lavabos

**42**



Bidé

**46**



Monomandos de superficie

**47**



Monomandos empotrados

**47**



Bañeras de repisa

**48**



Termostáticas de superficie

**48**



Termostáticas empotradas

**49**



Accesorios

**345**

[www.tresgriferia.com](http://www.tresgriferia.com)



**RECAMBIOS**  
DE LOS ARTÍCULOS EN  
[www.tresgriferia.com](http://www.tresgriferia.com)





**Monomando lavabo**

con caño cascada. **NOTA:** La grifería con caño cascada se acompaña con 2 llaves de regulación con filtro (Ref: 91-34-525).

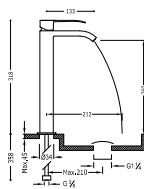
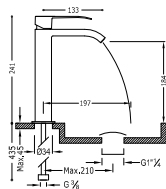
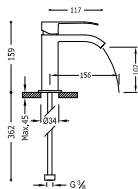

299 190.01

Ac 006.101.01.ACD

006.101.01.NED

006.101.01.BLD

299 190.01

Ac 006.610.01.ACD

006.610.01.NED

006.610.01.BLD

299 190.01

Ac 006.810.01.ACD

006.810.01.NED

006.810.01.BLD

**Monomando lavabo**

con caño cascada libre. **NOTA:** La grifería con caño cascada se acompaña con 2 llaves de regulación con filtro (Ref: 91.34.525).

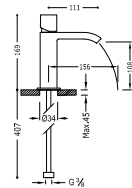

299.190.02

006.110.02.NE.D

006.110.02.BLD

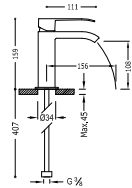

299.190.02

006.110.01.NE.D

006.110.01.BLD

**Monomando lavabo**

con caño cascada. **NOTA:** La grifería con caño cascada se acompaña con 2 llaves de regulación con filtro (Ref: 91.34.525).

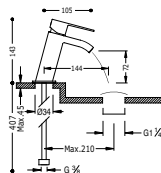

299.190.01

Ac 006.201.01.AC.D

006.201.01.NE.D

006.201.01.BLD

**Monomando lavabo**  
caño de 34x10 mm.

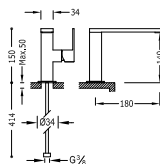

Ac 006.205.01.AC |

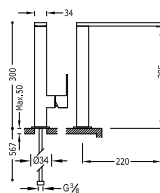

Ac 006.485.01.AC |

**Grifo lavabo 1 agua o premezclada**

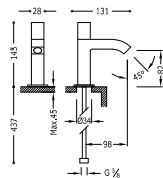

Ac 007.503.01.AC |

**Monomando mural**

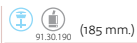
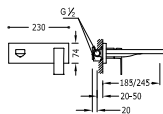

Ac 006.200.03.AC | (185 mm.)



Ac 006.200.04.AC | (245 mm.)

**Monomando mural**

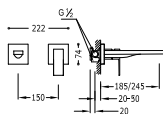

Ac 006.200.12.AC | (185 mm.)



Ac 006.200.11.AC | (245 mm.)

**Monomando lavabo de repisa**  
caño de 22x22 mm.

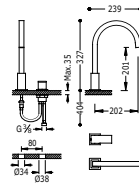

360° 91.30.190  
Ac | 006.105.03.AC |

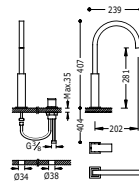

360° 91.30.190  
Ac | 006.105.04.AC |

**Bimando de repisa**  
caño de 22x22 mm.

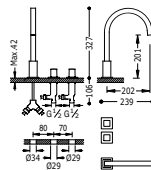

360° 91.34.262  
Ac | 008.105.03.AC |

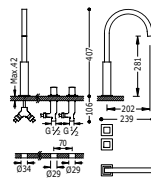

360° 91.34.262  
Ac | 008.105.04.AC |

Bimando mural

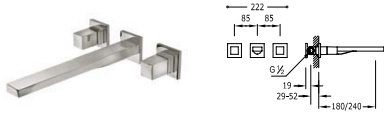

(180 mm.)  
91.34.282  
Ac **008.153.01.AC**

(240 mm.)  
91.34.282  
Ac **008.154.01.AC**

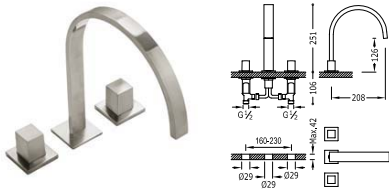

Bimando de repisa  
caño 35x15 mm. con aireador rectangular oculto

91.34.283  
Ac **008.105.01.AC**

BIDÉ

Monomando bidé

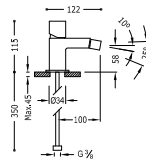

91.30.190  
Ac **007.120.01.ACD**  
**007.120.01.NE.D**  
**007.120.01.BLD**

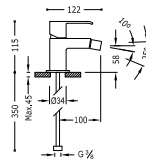

91.30.190  
Ac **006.120.01.ACD**  
**006.120.01.NE.D**  
**006.120.01.BLD**

SIMPLE-RAPID

Válvula con bloqueo superior

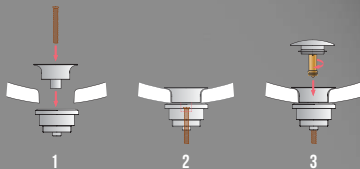

CLICK-CLACK



MONOMANDOS DE SUPERFICIE

Ref.:

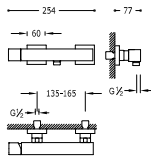

**Monomando ducha**

Ducha de mano anticalcárea con soporte orientable y flexo SATIN (91.34.609.15).



91.30.190	BELEGADA		
Ac	5.07.167.03		
	6.07.167		
	4.07.167		

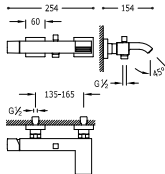

**Monomando bañera-ducha**

con cascada. Ducha de mano anticalcárea con soporte orientable y flexo SATIN (91.34.609).



91.30.190	BELEGADA		
Ac	5.07.170.02.03		
	6.07.170.02		
	4.07.170.02		

MONOMANDOS EMPOTRADOS

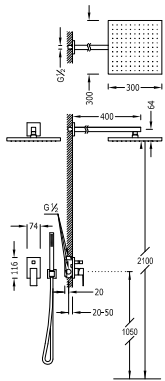

**Kit de ducha monomando empotrado**

- con cierre y regulación de caudal.
- Cuerpo empotrado incluido
- Ducha fija 300x300 mm. con rútila. Material Latón.
- Soporte con toma pared.
- Ducha móvil anticalcárea.
- Flexo SATIN (91.34.609.15).



91.30.190	BELEGADA		
	6.06.980		
	4.06.980		

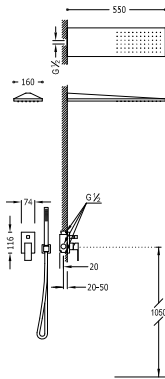

**Kit de ducha monomando empotrado**

- con cierre y regulación de caudal.
- Cuerpo empotrado incluido
- Rociador ducha INOX a pared 160x550 mm.
- Soporte con toma pared.
- Ducha móvil anticalcárea.
- Flexo SATIN (91.34.609.15).



91.30.190	BELEGADA		
Ac	006.180.03.AC		

BAÑERAS DE REPISA

Ref.:

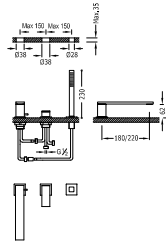

**Monomando bañera de repisa**  
 con ducha anticálcarea (006.639.01.AC).  
 · Caudal: 3 bar – 13 l/m.  
 · NOTA: ver longitud caño.

91.30.190 (180 mm.)  
 Ac **006.161.05.AC**

91.30.190 (220 mm.)  
 Ac **006.161.03.AC**

TERMOSTÁTICAS DE SUPERFICIE

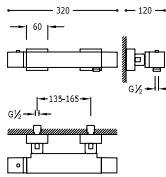

**Ducha termostática**  
 Ducha de mano anticálcarea con soporte orientable y flexo SATIN (91.34.609.15).

91.06.161.53  
 Ac **5.07.164.03.9**

91.06.161.16  
 91.06.161.14  
**6.07.164.9**  
**4.07.164.9**

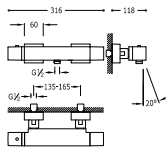

**Bañera-ducha termostática**  
 con cascada. Ducha de mano anticálcarea con soporte orientable y flexo SATIN (91.34.609).

91.06.161.53  
 Ac **5.07.174.03.9**

91.06.161.16  
 91.06.161.14  
**6.07.174.9**  
**4.07.174.9**



TRES TOUCH COOL

Sistema antiquemaduras

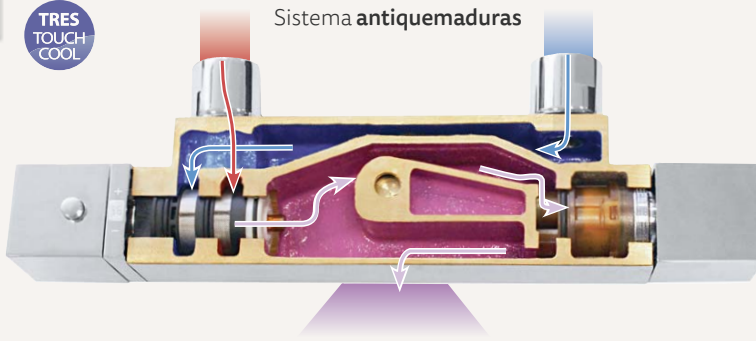

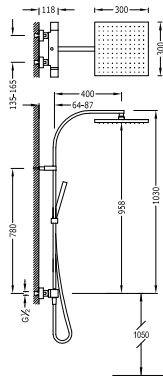

**Conjunto ducha termostática**

- Ducha fija 300x300 mm. con rótula. Material Latón.
- Ducha móvil anticalcárea.
- Flexo SATIN (91.34.609.15).
- Inversor integrado en el regulador de caudal.



■ 91.06.161.16	■ 91.06.161.14	REGULADA
■ 6.07.395		
■ 4.07.395		

**TERMOSTÁTICAS EMPOTRADAS**

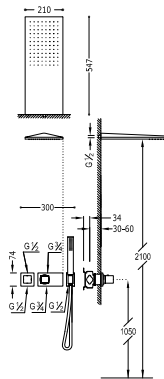

**Kit de ducha termostático empotrado BLOCK SYSTEM**

- con cierre y regulación de caudal (2 vías).
- Cuerpo empotrado termostático incluido
- Rociador ducha INOX a pared 210x550 mm.
- Ducha móvil anticalcárea.
- Flexo SATIN (91.34.609.15).

■ Ac	299.250.45.AC	■ 299.250.45.NE	■ 299.250.45.BL
Ac	207.252.02.AC	■ 207.252.02.NE	■ 207.252.02.BL
■ 207.252.02.AC			
■ 207.252.02.NE			





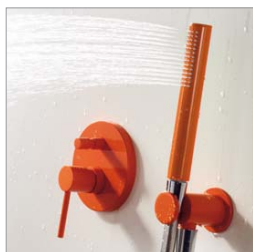
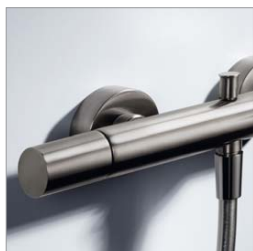
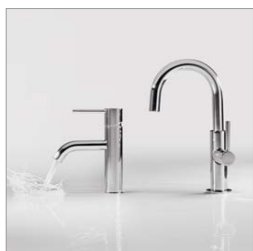

**RECAMBIOS**  
DE LOS ARTÍCULOS EN  
[www.tresgriferia.com](http://www.tresgriferia.com)

## STUDY EXCLUSIVE



Lavabos

**54**



Bidé

**61**



Monomandos de superficie

**62**



Monomandos empotrados

**63**



Bañeras de repisa

**66**



Termostáticas de superficie

**66**



Termostáticas empotradas

**68**



Termostáticas electrónicas empotradas

**69**



Accesorios

**346**

[www.tresgriferia.com](http://www.tresgriferia.com)





## Monomando lavabo

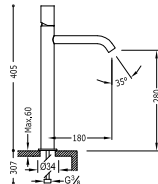
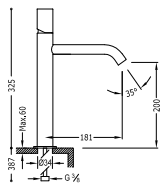
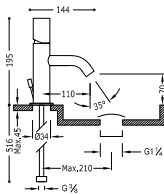

91.07.190.05

Cr | 261.903.01



91.07.190.05

Cr | 261.903.01.D



91.07.190.05

Cr | 261.307.01



91.07.190.05

Cr | 261.308.01





Monomando lavabo

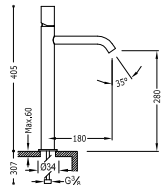
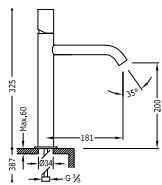
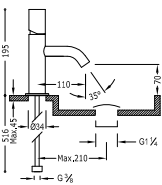

91.07.190.05	
Ac	261.903.01.ACD
Bi-Mt	261.903.01.BM.D
	261.903.01.TAM.D
	261.903.01.TNA.D
	261.903.01.TRO.D
	261.903.01.TVI.D
	261.903.01.TFU.D
	261.903.01.TVE.D
	261.903.01.TNE.D
	261.903.01.TBLD

91.07.190.05	
Ac	261.307.01.ACD
Bi-Mt	261.307.01.BM.D
	261.307.01.TAM.D
	261.307.01.TNA.D
	261.307.01.TRO.D
	261.307.01.TVI.D
	261.307.01.TFU.D
	261.307.01.TVE.D
	261.307.01.TNE.D
	261.307.01.TBLD

91.07.190.05	
Ac	261.308.01.ACD
Bi-Mt	261.308.01.BM.D
	261.308.01.TAM.D
	261.308.01.TNA.D
	261.308.01.TRO.D
	261.308.01.TVI.D
	261.308.01.TFU.D
	261.308.01.TVE.D
	261.308.01.TNE.D
	261.308.01.TBLD

Monomando lavabo

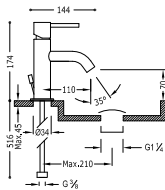

91.07.190.05  
Cr | **262.903.01** |

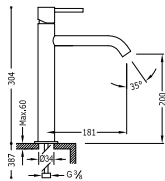

91.07.190.05  
Cr | **262.307.01** |

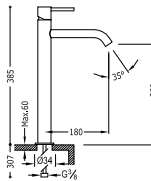

91.07.190.05  
Cr | **262.308.01** |



Monomando lavabo

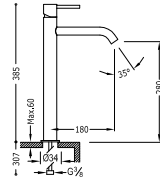
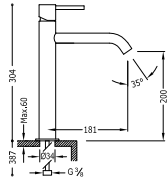
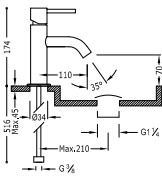

91.07.190.05	
Ac	262.903.01.AC.D
Bl-Mt	262.903.01.BM.D
	262.903.01.TAM.D
	262.903.01.TNA.D
	262.903.01.TRO.D
	262.903.01.TVL.D
	262.903.01.TFU.D
	262.903.01.TVE.D
	262.903.01.TNE.D
	262.903.01.TBLD

91.07.190.05	
Ac	262.307.01.AC.D
Bl-Mt	262.307.01.BM.D
	262.307.01.TAM.D
	262.307.01.TNA.D
	262.307.01.TRO.D
	262.307.01.TVL.D
	262.307.01.TFU.D
	262.307.01.TVE.D
	262.307.01.TNE.D
	262.307.01.TBLD

91.07.190.05	
Ac	262.308.01.AC.D
Bl-Mt	262.308.01.BM.D
	262.308.01.TAM.D
	262.308.01.TNA.D
	262.308.01.TRO.D
	262.308.01.TVL.D
	262.308.01.TFU.D
	262.308.01.TVE.D
	262.308.01.TNE.D
	262.308.01.TBLD

Ref:

Monomando lavabo

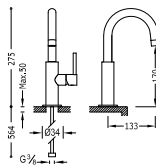

Cr 262.904.03

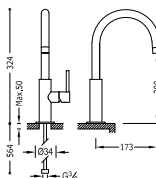

Cr 262.904.02

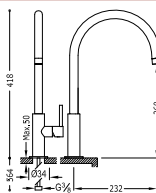

Cr 262.904.01

Monomando lavabo

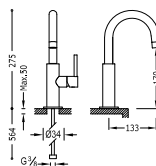

- Ac 262.904.03.AC.D
- BI-Mt 262.904.03.BM.D
- 262.904.03.TAM.D
- 262.904.03.TNA.D
- 262.904.03.TRO.D
- 262.904.03.TVI.D
- 262.904.03.TFU.D
- 262.904.03.TVE.D
- 262.904.03.TNE.D
- 262.904.03.TBL.D

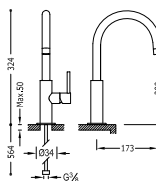

- Ac 262.904.02.AC.D
- BI-Mt 262.904.02.BM.D
- 262.904.02.TAM.D
- 262.904.02.TNA.D
- 262.904.02.TRO.D
- 262.904.02.TVI.D
- 262.904.02.TFU.D
- 262.904.02.TVE.D
- 262.904.02.TNE.D
- 262.904.02.TBL.D

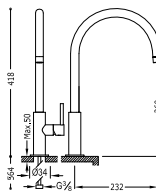

- Ac 262.904.01.AC.D
- BI-Mt 262.904.01.BM.D
- 262.904.01.TAM.D
- 262.904.01.TNA.D
- 262.904.01.TRO.D
- 262.904.01.TVI.D
- 262.904.01.TFU.D
- 262.904.01.TVE.D
- 262.904.01.TNE.D
- 262.904.01.TBL.D

Monomando mural

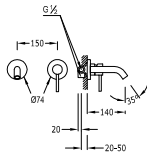

91.30.190  
Cr | 262.200.80

Monomando mural

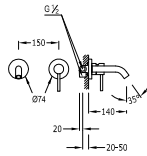

- 91.30.190
- Ac 262.200.80.AC
  - BI-Mt 262.200.80.BM
  - 262.200.80.TAM
  - 262.200.80.TNA
  - 262.200.80.TRO
  - 262.200.80.TVI
  - 262.200.80.TFU
  - 262.200.80.TVE
  - 262.200.80.TNE
  - 262.200.80.TBL

Monomando mural

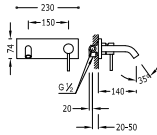

91.30.190  
Cr | 262.200.50

Monomando mural

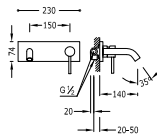

- 91.30.190
- Ac 262.200.50.AC
  - BI-Mt 262.200.50.BM
  - 262.200.50.TAM
  - 262.200.50.TNA
  - 262.200.50.TRO
  - 262.200.50.TVI
  - 262.200.50.TFU
  - 262.200.50.TVE
  - 262.200.50.TNE
  - 262.200.50.TBL

Monomando lavabo de repisa

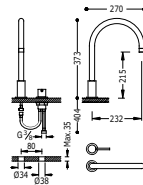

	360 * 91.30.190
Cr	261.105.01
Ac	261.105.01.AC

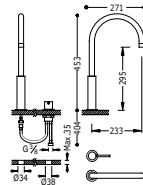

	360 * 91.30.190
Cr	261.105.02
Ac	261.105.02.AC

Bimando repisa

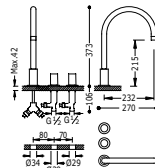

	360 * 299.105.01
Cr	061.105.01

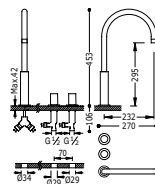

	360 * 299.105.01
Cr	061.105.02

Monomando bidé

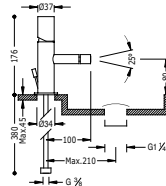

91.07.190.05

Cr | 261.120.01

91.07.190.05

Cr | 261.120.01.D

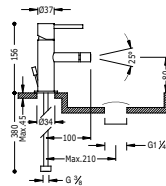

91.07.190.05

Cr | 262.120.01

91.07.190.05

Cr | 262.120.01.D

Monomando bidé

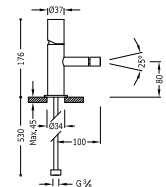

91.07.190.05

Ac | 061.120.01.ACD

BI-Mt | 061.120.01.BM.D

061.120.01.TAM.D

061.120.01.TNA.D

061.120.01.TRO.D

061.120.01.TVL.D

061.120.01.TFU.D

061.120.01.TVE.D

061.120.01.TNE.D

061.120.01.TBL.D

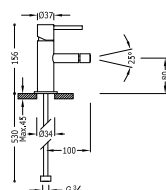

91.07.190.05

Ac | 062.120.01.ACD

BI-Mt | 062.120.01.BM.D

062.120.01.TAM.D

062.120.01.TNA.D

062.120.01.TRO.D

062.120.01.TVL.D

062.120.01.TFU.D

062.120.01.TVE.D

062.120.01.TNE.D

062.120.01.TBL.D

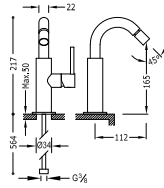

Monomando bidé

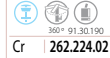

Monomando bidé

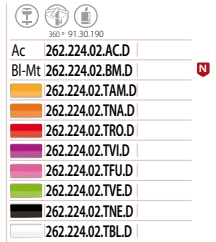
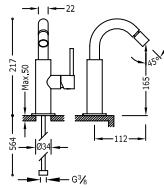

MONOMANDOS DE SUPERFICIE

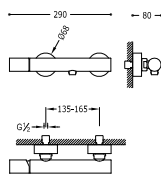

Monomando ducha

Ducha de mano anticálcarea (034.116.01) con soporte orientable y flexo SATIN (91.34.609.15).

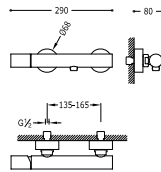

Monomando ducha

Ducha de mano anticálcarea con soporte orientable y flexo SATIN (91.34.609.15).

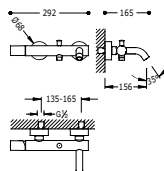

Monomando bañera-ducha

Ducha de mano anticálcarea (034.116.01) con soporte orientable y flexo SATIN (91.34.609).





Ref: |

**Monomando bañera-ducha**

Ducha de mano anticalcárea con soporte orientable y flexo SATIN (91.34.609).

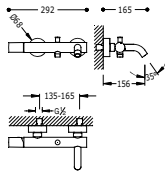

91.30.190

Ac	261.170.01.AC	
Bi-Mt	261.170.01.BM	N
	261.170.01.TAM	
	261.170.01.TNA	
	261.170.01.TRO	
	261.170.01.TVI	
	261.170.01.TFU	
	261.170.01.TVE	
	261.170.01.TNE	
	261.170.01.TBL	

**MONOMANDOS EMPOTRADOS**

**Monomando empotrar (1 vía)**

cuerpo empotrado incluido

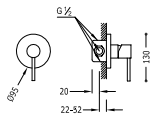

91.30.190

Cr | 262.177.90

**Monomando empotrar (2 vías)**

cuerpo empotrado incluido

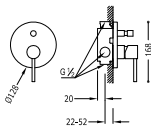

91.30.190

Cr | 262.180.90

**Kit de ducha monomando empotrado**

con cierre y regulación de caudal.

- Cuerpo empotrado incluido
- Soporte con toma pared (205.182.01).
- Ducha móvil anticalcárea (034.116.01).
- Flexo SATIN (91.34.609.15).

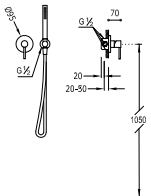

91.30.190

Cr | 262.177.92

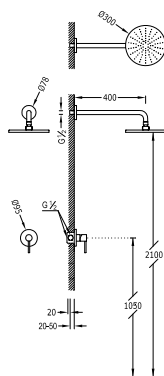

**Kit de ducha monomando empotrado**

con cierre y regulación de caudal.

- Cuerpo empotrado incluido
- Ducha fija Ø 300 mm. con rótula. Material Latón. (1.34.137.30).



91.30.190

Cr 262.177.93

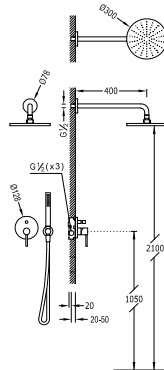

**Kit de ducha monomando empotrado**

con cierre y regulación de caudal.

- Cuerpo empotrado incluido
- Ducha fija Ø 300 mm. con rótula. Material Latón. (1.34.137.30).
- Soporte con toma pared (205.182.01).
- Ducha móvil anticalcárea (034.116.01).
- Flexo SATIN (91.34.609.15).



91.30.190

Cr 262.980.91

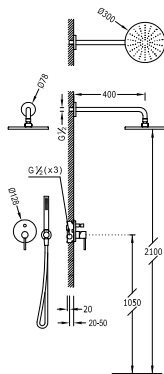

**Kit de ducha monomando empotrado**

con cierre y regulación de caudal.

- Cuerpo empotrado incluido
- Ducha fija Ø 300 mm. con rótula. Material Latón.
- Soporte con toma pared.
- Ducha móvil anticalcárea.
- Flexo SATIN (91.34.609.15).



91.30.190

Ac	262.980.91.AC	
Bl-Mt	262.980.91.BM	
	262.980.91.TAM	
	262.980.91.TNA	
	262.980.91.TRO	
	262.980.91.TVI	
	262.980.91.TFU	
	262.980.91.TVE	
	262.980.91.TNE	
	262.980.91.TBL	

**N**

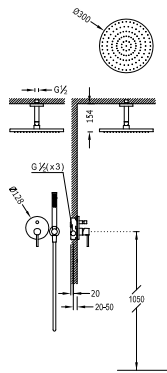

**Kit de ducha monomando empotrado**

con cierre y regulación de caudal.

- Cuerpo empotrado incluido
- Ducha fija Ø 300 mm, con rótula. Material Latón. (1.34.137.30).
- Soporte con toma pared (205.182.01).
- Ducha móvil anticalcárea (034.116.01).
- Flexo SATIN (91.34.609.15).



91.30.190

Cr | 262.180.80 |

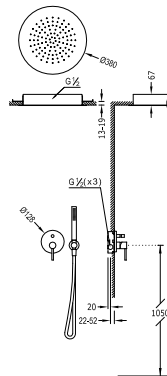

**Kit de ducha monomando empotrado**

con cierre y regulación de caudal.

- Cuerpo empotrado incluido
- Rociador ducha INOX a techo Ø 380 mm. (1.34.940).
- Soporte con toma pared (205.182.01).
- Ducha móvil anticalcárea (034.116.01).
- Flexo SATIN (91.34.609.15).



91.30.190

Cr | 262.180.99 |

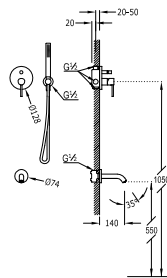

**Kit de ducha monomando empotrado**

con cierre y regulación de caudal.

- Cuerpo empotrado incluido.
- Caño bañera.
- Soporte con toma pared (205.182.01).
- Ducha móvil anticalcárea (034.116.01).
- Flexo SATIN (91.34.609.15).



91.30.190

Cr | 262.180.03 |



**Kit de ducha monomando empotrado**

con cierre y regulación de caudal.

- Cuerpo empotrado incluido.
- Caño bañera.
- Soporte con toma pared.
- Ducha móvil anticalcárea.
- Flexo SATIN (91.34.609.15).

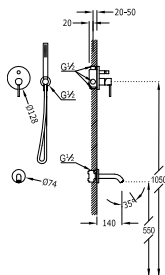

91.30.190	
Ac	262.180.03.AC
Bl-Mt	262.180.03.BM
	262.180.03.TAM
	262.180.03.TNA
	262.180.03.TRO
	262.180.03.TVI
	262.180.03.TFU
	262.180.03.TVE
	262.180.03.TNE
	262.180.03.TBL

**BAÑERAS DE REPISA**

**Monomando bañera de repisa**

con ducha anticalcárea.

- Caudal: 3 bar – 14 l/m.

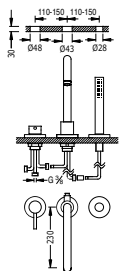

91.34.288	
Cr	261.150.01
91.34.288	
Cr	262.150.01
Ac	062.150.01.AC

**TERMOSTÁTICAS DE SUPERFICIE**

**Ducha termostática**

Ducha de mano anticalcárea con soporte orientable y flexo SATIN (91.34.609.15).

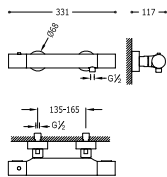

299.195.03	
Cr	261.162.09
299.195.03.AC	
Ac	261.162.09.AC



**Bañera-ducha termostática**

con cascada. Ducha de mano anticalcárea con soporte orientable y flexo SATIN (91.34.609).

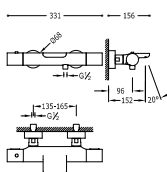

299.195.03	
Cr	261.172.09
299.195.03.AC	
Ac	261.172.09.AC

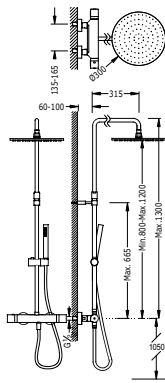

**Conjunto ducha termostática**

- Ducha fija Ø 300 mm. con rótula. Material Latón (1.34.137.30).
- Ducha móvil anticalcárea (034.116.01).
- Flexo SATIN (91.34.609.15).
- Barra telescópica.
- Inversor integrado en el regulador de caudal.



299.195.03

Cr | 261.210.01 |

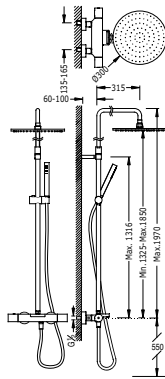

**Conjunto bañera-ducha termostática**

- Ducha fija Ø 300 mm. con rótula. Material Latón (1.34.137.30).
- Ducha móvil anticalcárea (034.116.01).
- Flexo SATIN (91.34.609).
- Barra telescópica.



299.195.03

Cr | 262.312.01 |



**REGULACIÓN DE ALTURA**

Barras de ducha telescópicas que dan la posibilidad de regular su altura.

TERMOSTÁTICAS EMPOTRADAS

Ref.:



Kit de ducha termostático empotrado BLOCK SYSTEM

- con cierre y regulación de caudal (2 vías).
- Cuerpo empotrado termostático incluido.
- Ducha fija Ø 300 mm. con rótula. Material Latón (1.34.137.30).
- Ducha móvil anticalcárea (034.116.01).
- Flexo SATIN (91.34.609.15).

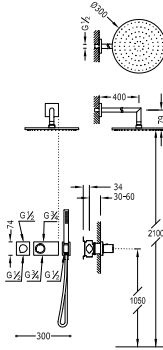

299 195.03



Cr 207.352.01



Kit de ducha termostático empotrado BLOCK SYSTEM

- con cierre y regulación de caudal (2 vías).
- Cuerpo empotrado termostático incluido.
- Ducha fija Ø 300 mm. con rótula. Material Latón.
- Ducha móvil anticalcárea.
- Flexo SATIN (91.34.609.15).

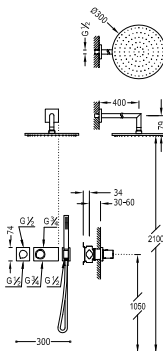

- Ac 299.195.03.AC
- Bl-Mt 299.195.03.Bl-Mt
- 299.195.03.TAM
- 299.195.03.TNA
- 299.195.03.TRO
- 299.195.03.TVI
- 299.195.03.TFU
- 299.195.03.TVE
- 299.195.03.TNE
- 299.195.03.TBL

- Ac 207.352.01.AC
- Bl-Mt 207.352.01.Bl-Mt
- 207.352.01.TAM
- 207.352.01.TNA
- 207.352.01.TRO
- 207.352.01.TVI
- 207.352.01.TFU
- 207.352.01.TVE
- 207.352.01.TNE
- 207.352.01.TBL





**Kit de ducha termostático empotrado BLOCK SYSTEM**

- con cierre y regulación de caudal (2 vías).
- Cuerpo empotrado termostático incluido.
- Rociador ducha INOX a pared 210x550 mm. (299.903.07).
- Ducha móvil anticálcarea (034.116.01).
- Flexo SATIN (91.34.609.15).

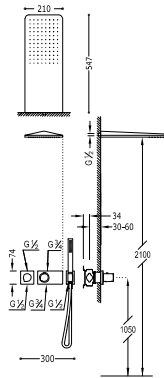

**TERMOSTÁTICAS ELECTRÓNICAS EMPOTRADAS**



**Kit electrónico de ducha termostático empotrado SHOWER TECHNOLOGY**

- Centralita termostática electrónica incluida (2 vías).
- Rociador ducha INOX a pared 210x550 mm. (299.903.07).
- Soporte con toma pared (207.182.01).
- Ducha móvil anticálcarea (034.116.01).
- Flexo SATIN (91.34.609.15).

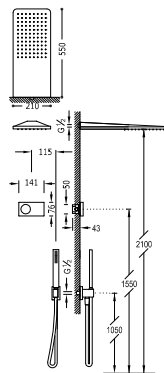

299.195.03  
Cr | **207.352.02** |



Cr | **092.865.54** |





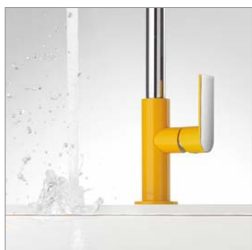
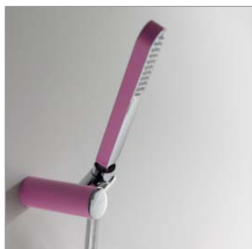

## LOFT COLORS



Lavabos

**74**



Bidé

**82**



Monomandos de superficie

**83**



Monomandos empotrados

**84**



Bañeras de repisa

**85**



Termostáticas de superficie

**85**



Termostáticas empotradas

**88**



Accesorios

**348**

[www.tresgriferia.com](http://www.tresgriferia.com)



**RECAMBIOS**  
DE LOS ARTÍCULOS EN  
[www.tresgriferia.com](http://www.tresgriferia.com)



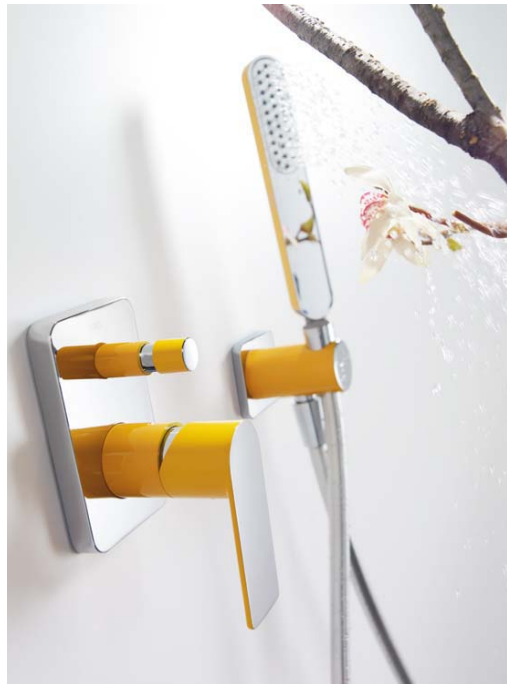

Monomando lavabo

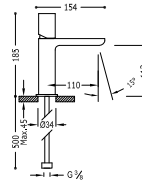

91.30.190

- 200.103.02.AM.D
- 200.103.02.NA.D
- 200.103.02.RO.D
- 200.103.02.VI.D
- 200.103.02.FU.D
- 200.103.02.VE.D
- 200.103.02.NE.D
- 200.103.02.BL.D

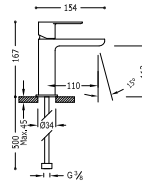

91.30.190

- 200.103.01.AM.D
- 200.103.01.NA.D
- 200.103.01.RO.D
- 200.103.01.VI.D
- 200.103.01.FU.D
- 200.103.01.VE.D
- 200.103.01.NE.D
- 200.103.01.BL.D

Monomando lavabo

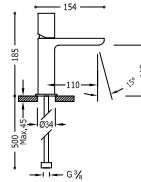

91.30.190

- Ac 200.103.02.ACD
- BI-Mt 200.103.02.BMD

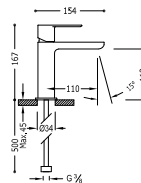

91.30.190

- Ac 200.103.01.ACD
- BI-Mt 200.103.01.BMD

**Monomando lavabo**

con caño cascada libre. NOTA: La grifería con caño cascada se acompaña con 2 llaves de regulación con filtro (Ref: 91.34.525).

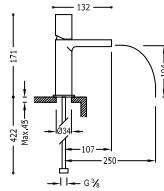

91.30.190	
	200.110.02.AM.D
	200.110.02.NA.D
	200.110.02.RO.D
	200.110.02.VI.D
	200.110.02.FU.D
	200.110.02.VE.D
	200.110.02.NE.D
	200.110.02.BLD

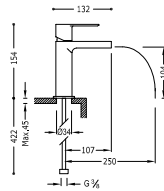

91.30.190	
	200.110.01.AM.D
	200.110.01.NA.D
	200.110.01.RO.D
	200.110.01.VI.D
	200.110.01.FU.D
	200.110.01.VE.D
	200.110.01.NE.D
	200.110.01.BLD

Monomando lavabo

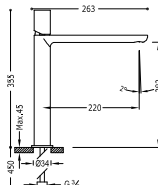
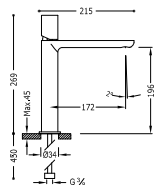
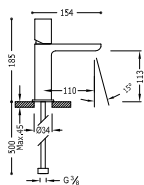

91.30.190		
	200.103.02.AM.D	
	200.103.02.NA.D	
	200.103.02.RO.D	
	200.103.02.VI.D	
	200.103.02.FU.D	
	200.103.02.VE.D	
	200.103.02.NE.D	
	200.103.02.BL.D	

91.30.190		
	200.203.04.AM.D	N
	200.203.04.NA.D	N
	200.203.04.RO.D	N
	200.203.04.VI.D	N
	200.203.04.FU.D	N
	200.203.04.VE.D	N
	200.203.04.NE.D	N
	200.203.04.BL.D	N

91.30.190		
	200.203.06.AM.D	N
	200.203.06.NA.D	N
	200.203.06.RO.D	N
	200.203.06.VI.D	N
	200.203.06.FU.D	N
	200.203.06.VE.D	N
	200.203.06.NE.D	N
	200.203.06.BL.D	N

Monomando lavabo

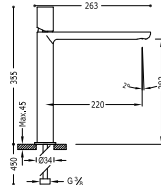
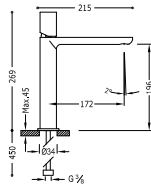
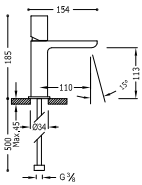

91.30.190

Ac **200.103.02.AC.D**

Bl-Mt **200.103.02.BM.D**

91.30.190

Ac **200.203.04.AC.D**

Bl-Mt **200.203.04.BM.D**

91.30.190

Ac **200.203.06.AC.D**

Bl-Mt **200.203.06.BM.D**

Monomando lavabo

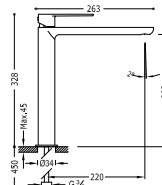
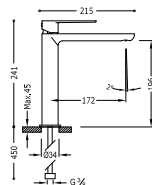
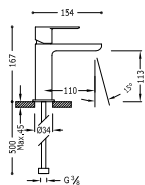

Color	Code	Availability
Orange	200.103.01.AM.D	
Red	200.103.01.NA.D	
Dark Red	200.103.01.RO.D	
Pink	200.103.01.VI.D	
Purple	200.103.01.FU.D	
Light Green	200.103.01.VE.D	
Black	200.103.01.NE.D	
White	200.103.01.BLD	

Color	Code	Availability
Orange	200.203.03.AM.D	N
Red	200.203.03.NA.D	N
Dark Red	200.203.03.RO.D	N
Pink	200.203.03.VI.D	N
Purple	200.203.03.FU.D	N
Light Green	200.203.03.VE.D	N
Black	200.203.03.NE.D	N
White	200.203.03.BLD	N

Color	Code	Availability
Orange	200.203.05.AM.D	N
Red	200.203.05.NA.D	N
Dark Red	200.203.05.RO.D	N
Pink	200.203.05.VI.D	N
Purple	200.203.05.FU.D	N
Light Green	200.203.05.VE.D	N
Black	200.203.05.NE.D	N
White	200.203.05.BLD	N



Monomando lavabo

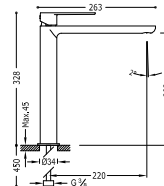
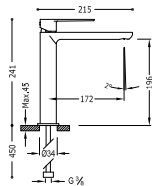
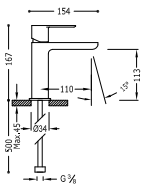

91.30.190
   
**Ac 200.103.01.AC.D**
  
**Bi-Mt 200.103.01.BM.D**

91.30.190
   
**Ac 200.203.03.AC.D**
  
**Bi-Mt 200.203.03.BM.D**

91.30.190
   
**Ac 200.203.05.AC.D**
  
**Bi-Mt 200.203.05.BM.D**

Ref:

Monomando lavabo

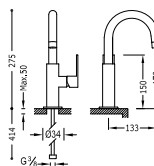

360° 91.30.190

- 200.205.04.AM.D
- 200.205.04.NA.D
- 200.205.04.RO.D
- 200.205.04.VI.D
- 200.205.04.FU.D
- 200.205.04.VE.D
- 200.205.04.NE.D
- 200.205.04.BL.D

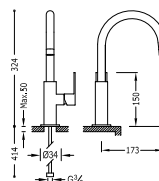

360° 91.30.190

- 200.205.05.AM.D
- 200.205.05.NA.D
- 200.205.05.RO.D
- 200.205.05.VI.D
- 200.205.05.FU.D
- 200.205.05.VE.D
- 200.205.05.NE.D
- 200.205.05.BL.D

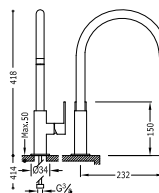

360° 91.30.190

- 200.205.06.AM.D
- 200.205.06.NA.D
- 200.205.06.RO.D
- 200.205.06.VI.D
- 200.205.06.FU.D
- 200.205.06.VE.D
- 200.205.06.NE.D
- 200.205.06.BL.D

Monomando lavabo

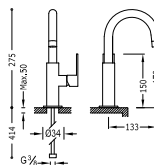

360° 91.30.190

- Ac 200.205.04.ACD
- Bl-Mt 200.205.04.BM.D

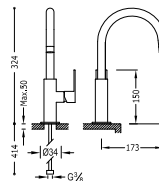

360° 91.30.190

- Ac 200.205.05.ACD
- Bl-Mt 200.205.05.BM.D

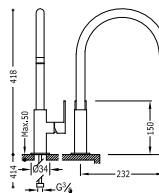

360° 91.30.190

- Ac 200.205.06.ACD
- Bl-Mt 200.205.06.BM.D

Ref:

Monomando lavabo  
caño de 35x15 mm.

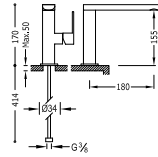

360° 91.30.190	
200.205.01.AM.D	
200.205.01.NA.D	
200.205.01.RO.D	
200.205.01.VI.D	
200.205.01.FU.D	
200.205.01.VE.D	
200.205.01.NE.D	
200.205.01.BL.D	

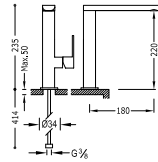

360° 91.30.190	
200.205.02.AM.D	
200.205.02.NA.D	
200.205.02.RO.D	
200.205.02.VI.D	
200.205.02.FU.D	
200.205.02.VE.D	
200.205.02.NE.D	
200.205.02.BL.D	

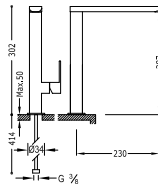

360° 91.30.190	
200.205.03.AM.D	
200.205.03.NA.D	
200.205.03.RO.D	
200.205.03.VI.D	
200.205.03.FU.D	
200.205.03.VE.D	
200.205.03.NE.D	
200.205.03.BL.D	

Monomando lavabo  
caño de 35x15 mm.

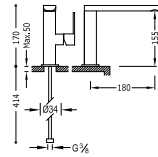

360° 91.30.190	
Ac 200.205.01.AC.D	
Bl-Mt 200.205.01.BM.D	

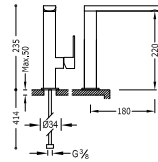

360° 91.30.190	
Ac 200.205.02.AC.D	
Bl-Mt 200.205.02.BM.D	

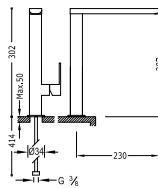

360° 91.30.190	
Ac 200.205.03.AC.D	
Bl-Mt 200.205.03.BM.D	

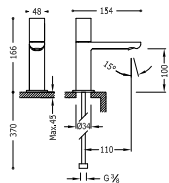

Grifo lavabo 1 agua o premezclada



91.34.282

Ac 200.503.01.AC

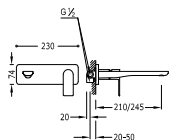

Monomando mural



91.30.190 (245 mm)

Ac 200.200.02.AC



BIDÉ

Monomando bidé

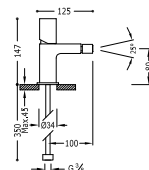

91.30.190

- 200.120.02.AM.D
- 200.120.02.NA.D
- 200.120.02.RO.D
- 200.120.02.VI.D
- 200.120.02.FU.D
- 200.120.02.VE.D
- 200.120.02.NE.D
- 200.120.02.BL.D



Monomando bidé

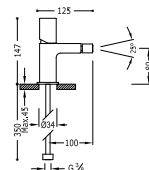

91.30.190

Ac 200.120.02.AC.D  
Bl-Mt 200.120.02.BM.D

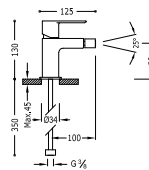

91.30.190

Ac 200.120.01.AC.D  
Bl-Mt 200.120.01.BM.D



Ref: \_\_\_\_\_

**Monomando bidé**

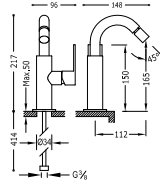

- 200.224.01.AM.D
- 200.224.01.NA.D
- 200.224.01.RO.D
- 200.224.01.VLD
- 200.224.01.FU.D
- 200.224.01.VE.D
- 200.224.01.NE.D
- 200.224.01.BLD

**Monomando bidé**

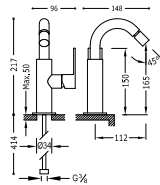

- Ac 200.224.01.AC.D
- Bl-Mt 200.224.01.BM.D

**MONOMANDOS DE SUPERFICIE**

**Monomando ducha**

Ducha de mano anticalcárea con soporte orientable y flexo SATIN (91.34.609.15).

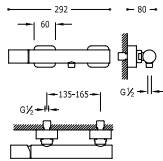

- 200.167.01.AM
- 200.167.01.NA
- 200.167.01.RO
- 200.167.01.VI
- 200.167.01.FU
- 200.167.01.VE
- 200.167.01.NE
- 200.167.01.BL

**Monomando ducha**

Ducha de mano anticalcárea con soporte orientable y flexo SATIN (91.34.609.15).

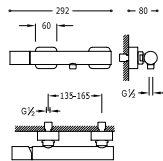

- Ac 200.167.01.AC
- Bl-Mt 200.167.01.BM

**Monomando bañera-ducha**

con cascada. Ducha de mano anticalcárea con soporte orientable y flexo SATIN (91.34.609).

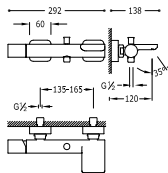

91.30.190

	200.170.01.AM
	200.170.01.NA
	200.170.01.RO
	200.170.01.VI
	200.170.01.FU
	200.170.01.VE
	200.170.01.NE
	200.170.01.BL

**Monomando bañera-ducha**

con cascada. Ducha de mano anticalcárea con soporte orientable y flexo SATIN (91.34.609).

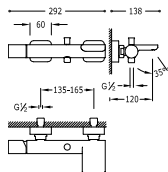

91.30.190

Ac	200.170.01.AC
Bl-Mt	200.170.01.BM

**MONOMANDOS EMPOTRADOS**

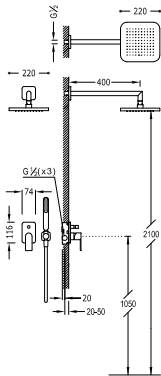

**Kit de ducha monomando empotrado**

- con cierre y regulación de caudal.
- Cuerpo empotrado incluido
- Ducha fija 220x220 mm. con rótula. (299.632.06).
- Soporte con toma pared.
- Ducha móvil anticalcárea.
- Flexo SATIN (91.34.609.15).



91.30.190

	200.180.02.AM
	200.180.02.NA
	200.180.02.RO
	200.180.02.VI
	200.180.02.FU
	200.180.02.VE
	200.180.02.NE
	200.180.02.BL

Ref: |

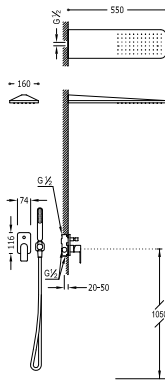

**Kit de ducha monomando empotrado**

- con cierre y regulación de caudal.
- Cuerpo empotrado incluido
- Rociador ducha INOX a pared 160x550 mm.
- Soporte con toma pared.
- Ducha móvil anticalcárea.
- Flexo SATIN (91.34.609.15).



91.30.190

Ac | 200.180.05.AC |  
Bl-Mt | 200.180.05.BM |



**BAÑERAS DE REPISA**

**Monomando bañera de repisa**

- con ducha anticalcárea.
- Caudal: 3 bar - 16 l/m.
- NOTA: ver longitud caño.

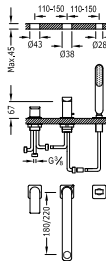

91.34.591 (180 mm.)

Ac | 200.162.03.AC |



91.34.591 (220 mm.)

Ac | 200.162.01.AC |

**TERMOSTÁTICAS DE SUPERFICIE**

**Ducha termostática**

- Ducha de mano anticalcárea con soporte orientable y flexo SATIN (91.34.609.15).

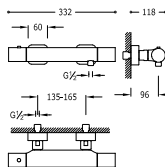

- 299.195.03.AM
- 299.195.03.NA
- 299.195.03.RO
- 299.195.03.VI
- 299.195.03.FU
- 299.195.03.VE
- 299.195.03.NE
- 299.195.03.BL



200.164.09.AM |

200.164.09.NA |

200.164.09.RO |

200.164.09.VI |

200.164.09.FU |

200.164.09.VE |

200.164.09.NE |

200.164.09.BL |



**Ducha termostática**

Ducha de mano anticalcárea con soporte orientable y flexo SATIN (91.34.609.15).

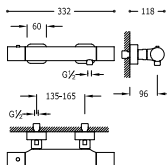

Ac **200.164.09.AC**  
BI-Mt **200.164.09.BM**

**Bañera-ducha termostática**

con cascada. Ducha de mano anticalcárea con soporte orientable y flexo SATIN (91.34.609).

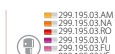
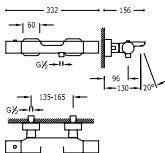

Ac 299.195.03.AC  
BI-Mt 299.195.03.BM

- 299.195.03.AM
- 299.195.03.NA
- 299.195.03.RO
- 299.195.03.VI
- 299.195.03.FU
- 299.195.03.VE
- 299.195.03.NE
- 299.195.03.BL

**200.174.09.AM**  
**200.174.09.NA**  
**200.174.09.RO**  
**200.174.09.VI**  
**200.174.09.FU**  
**200.174.09.VE**  
**200.174.09.NE**  
**200.174.09.BL**

**Bañera-ducha termostática**

con cascada. Ducha de mano anticalcárea con soporte orientable y flexo SATIN (91.34.609).

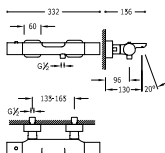

Ac **200.174.09.AC**  
BI-Mt **200.174.09.BM**



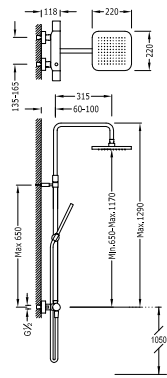

**Conjunto ducha termostática**

- Ducha fija 220x220 mm. con rótula. (299.632.06).
- Ducha móvil anticalcárea.
- Flexo SATIN (91.34.609.15).
- Barra telescópica.
- Inversor integrado en el regulador de caudal.



	200.195.01.AM
	200.195.01.NA
	200.195.01.RO
	200.195.01.VI
	200.195.01.FU
	200.195.01.VE
	200.195.01.NE
	200.195.01.BL





**easy  
CLEAN**

**FÁCIL  
MANTENIMIENTO**

Con la tecnología EasyCLEAN®, TRES ofrece la posibilidad de limpiar fácilmente el cartucho en caso de obstrucción sin perder su calibración.

TERMOSTÁTICAS EMPOTRADAS

Ref.:

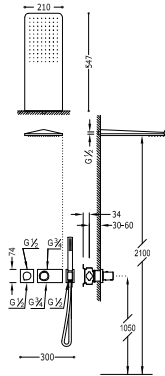

Kit de ducha termostático empotrado BLOCK SYSTEM

- con cierre y regulación de caudal (2 vías).
- Cuerpo empotrado termostático incluido
- Rociador ducha INOX a pared 210x550 mm. (299.903.07)
- Ducha móvil anticalcárea.
- Flexo SATIN (91.34.609.15).

	207.352.02.AM
	207.352.02.NA
	207.352.02.RO
	207.352.02.VI
	207.352.02.FU
	207.352.02.VE
	207.352.02.NE
	207.352.02.BL

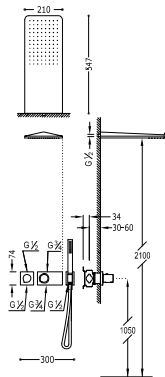

Kit de ducha termostático empotrado BLOCK SYSTEM

- con cierre y regulación de caudal (2 vías).
- Cuerpo empotrado termostático incluido
- Rociador ducha INOX a pared 210x550 mm.
- Ducha móvil anticalcárea.
- Flexo SATIN (91.34.609.15).

	Ac 299.195.03.AC
	Bl-Mt 299.195.03.BM
	Ac 207.352.02.AC
	Bl-Mt 207.352.02.BM









## COCINA EXCLUSIVE



Monomando

**96**



Con caño extraíble

**99**



Abatible

**100**



Mural

**100**

[www.tresgriferia.com](http://www.tresgriferia.com)



**RECAMBIOS**  
DE LOS ARTÍCULOS EN  
[www.tresgriferia.com](http://www.tresgriferia.com)





## Características generales

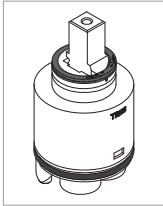

### Cartucho cerámico Patentado®

El cartucho TRES evita el desgaste de los discos con el grifo cerrado, alargando la vida útil del mismo.

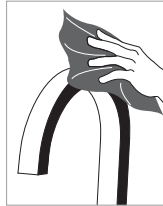

### Acabados especiales

Piezas resistentes acabadas y pulidas a mano con pinturas ecológicas libres de disolventes.

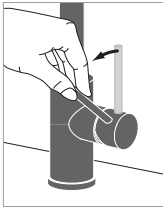

### Maneta con rotación frontal

Evita que la maneta choque contra la pared.

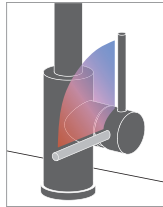

### Ahorro energético con Cold-Tres®

El grifo se abre siempre en agua fría, evitando el encendido innecesario del calentador.

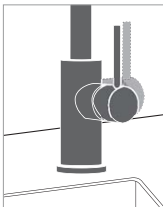

### Instalación variable

La posición del monomando se puede instalar a la derecha o central según las necesidades personales.



### Diseños modernos y minimalistas

Combinan el cromado con varios colores, además de acabados en acero y en blanco-mate.

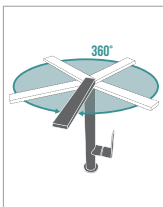

### Caño giratorio

Con completa libertad de movimiento a 360°.

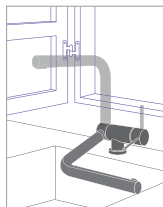

### Abatible

Ideal para instalaciones frente a ventanas o armarios. Esta grifería permite rotar y abatir cuando sea necesario.

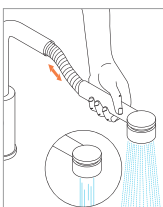

### Caño o ducha retráctil

Incrementa el radio de acción y puede ofrecer distintos tipos de chorro.

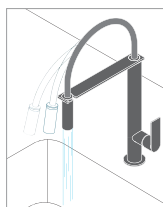

### Caño extraíble

Permiten ampliar la zona de trabajo de 50 a 70 cm.





**Acero** / Acabado en acero, da un toque profesional y actual.  
**Blanco-Mate** / Completamente de color blanco mate, que da singularidad y fineza a la pieza.

COCINA MONOMANDO

Ref.:

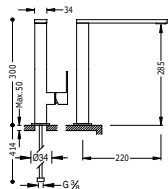

Monomando fregadero vertical CUADRO  
caño de 34x10 mm.



Ø 35	360°	91.30.190
	1.06.486.AM	
	1.06.486.NA	
	1.06.486.RO	
	1.06.486.VI	
	1.06.486.FU	
	1.06.486.VE	
	6.06.486	
	4.06.486	

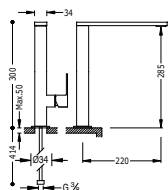

Monomando fregadero vertical CUADRO  
caño de 34x10 mm.



Ø 35	360°	91.30.190
Ac	5.06.486.03	
Bi-Mt	006.486.BM	

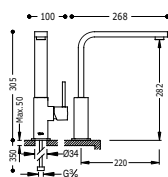

Monomando fregadero vertical CUADRO  
caño de 35x15 mm.

Ø 35	360°	91.30.190
Ac	5.30.496.03	
Bi-Mt	030.496.BM	

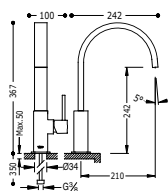

Monomando fregadero vertical CUADRO  
caño 35x15 mm. con aireador rectangular oculto

Ø 35	360°	91.30.190
Ac	5.30.498.03	
Bi-Mt	030.498.BM	

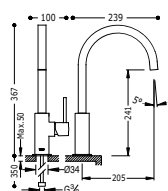

Monomando fregadero vertical CUADRO  
caño de 22x22 mm.

Ø 35	360°	91.30.190
Ac	5.30.497.03	
Bi-Mt	030.497.BM	

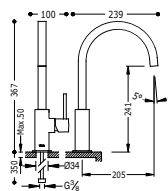

Monomando fregadero vertical CUADRO  
caño de 22x22 mm.

Ø 35	360°	91.30.190
	1.30.497.AM	
	1.30.497.NA	
	1.30.497.RO	
	1.30.497.VI	
	1.30.497.FU	
	1.30.497.VE	
	6.30.497	
	4.30.497	

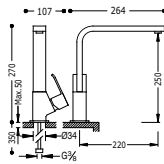

**Monomando fregadero vertical CUADRO**  
caño de 35x15 mm



Ac | 5.06.440.03

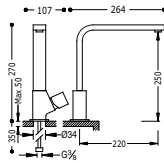

**Monomando fregadero vertical CUADRO**  
caño de 35x15 mm.



Ac | 5.07.440.03

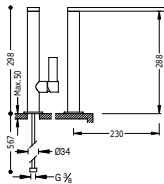

**Monomando fregadero vertical CLASS**  
caño de 34x9 mm.



Ac | 205.486.01.AC

Bi-Mt | 205.486.01.BM

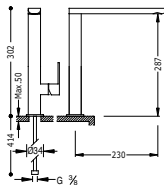

**Monomando fregadero vertical LOFT**  
caño de 34x15 mm.



Ac | 200.440.01.AM

Ac | 200.440.01.NA

Ac | 200.440.01.RO

Ac | 200.440.01.VI

Ac | 200.440.01.FU

Ac | 200.440.01.VE

Ac | 200.440.01.NE

Ac | 200.440.01.BL

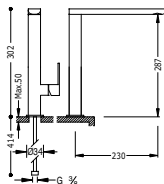

**Monomando fregadero vertical LOFT**  
caño de 34x15 mm.



Ac | 200.440.01.AC

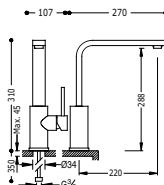

**Monomando fregadero vertical**  
caño de 35x15 mm.



Ac | 062.435.AC

Bi-Mt | 062.435.BM



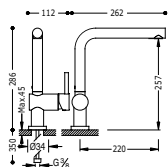

Monomando fregadero vertical



Ac **030.336.AC**  
 BI-Mt **030.336.BM**

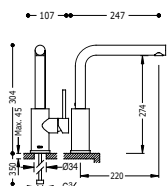

Monomando fregadero vertical MAX



Ac **062.436.01.AC**  
 BI-Mt **062.436.01.BM**

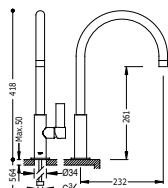

Monomando fregadero vertical CLASS



Ac **205.440.01.AC**  
 BI-Mt **205.440.01.BM**

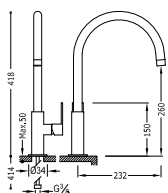

Monomando fregadero vertical LOFT



Ac **200.440.02.AC**  
 BI-Mt **200.440.02.BM**

- 200.440.02.AM**
- 200.440.02.NA**
- 200.440.02.RO**
- 200.440.02.VI**
- 200.440.02.FU**
- 200.440.02.VE**
- 200.440.02.NE**
- 200.440.02.BL**

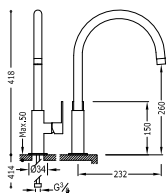

Monomando fregadero vertical LOFT



Ac **200.440.02.AC**  
 BI-Mt **200.440.02.BM**

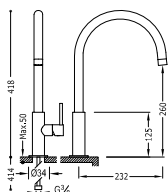

Monomando fregadero vertical MAX



Ac **062.542.01.AC**  
 BI-Mt **062.542.01.BM**

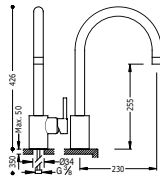

Monomando fregadero vertical MAX



Ac 5.62.440.03

## DISEÑOS FUNCIONALES

Para aquellos lugares donde es necesaria una mayor comodidad y libertad de acción.



### COCINA EXTRAÍBLE

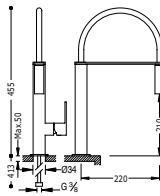

Monomando fregadero vertical CUADRO con rociador extraíble.



0.35 360° 91.30.190  
 1.06.487.AM  
 1.06.487.NA  
 1.06.487.RO  
 1.06.487.VI  
 1.06.487.FU  
 1.06.487.VE  
 6.06.487  
 4.06.487

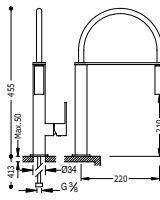

Monomando fregadero vertical CUADRO con rociador extraíble.



0.35 360° 91.30.190  
 Ac 5.06.487.03  
 Bi-Mt 006.487.BM

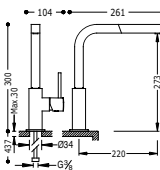

Monomando fregadero vertical CUADRO con ducha extraíble.



0.35 360° 91.07.190.05  
 Ac 5.06.437.03  
 Bi-Mt 006.437.BM

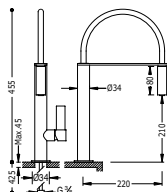

Monomando fregadero vertical CLASS  
con rociador extraíble.



Ac 205.487.01.AC  
Bl-Mt 205.487.01.BM

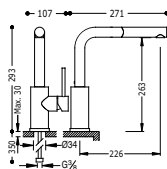

Monomando fregadero vertical MAX  
con ducha extraíble.



Ac 5.62.437.03

COCINA ABATIBLE

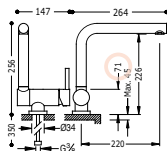

Monomando fregadero vertical ABATIBLE



Ac 030.335.AC



Bl-Mt 030.335.BM

COCINA MURAL

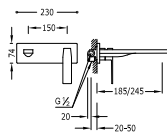

Monomando mural SLIM

91.30.190 (185 mm.)  
Cr 202.200.03

91.30.190 (245 mm.)  
Cr 202.200.04  
Ac 202.200.04.AC

Monomando mural CUADRO

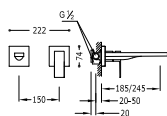

91.30.190 (185 mm.)  
Ac 006.200.12.AC

91.30.190 (245 mm.)  
Ac 006.200.11.AC

Monomando mural CUADRO

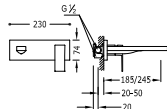

91.30.190 (185 mm.)  
Ac 006.200.03.AC

91.30.190 (245 mm.)  
Ac 006.200.04.AC

Bimando mural CUADRO

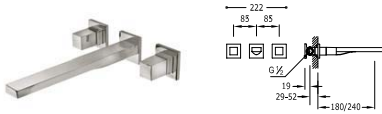

91.34.282 (180 mm.)

Ac | 008.153.01.AC |

91.34.282 (240 mm.)

Ac | 008.154.01.AC |

Monomando mural LOFT

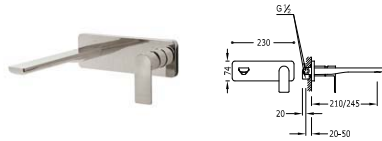

91.30.190 (245 mm.)

Ac | 200.200.02.AC |

Monomando mural CLASS



91.30.190 (210 mm.)

Ac | 205.200.41.AC |

91.30.190 (250 mm.)

Ac | 205.200.01.AC |

Monomando mural CLASS



91.30.190 (210 mm.)

Ac | 205.200.71.AC |

91.30.190 (250 mm.)

Ac | 205.200.02.AC |

Monomando mural MAX



91.30.190 (210 mm.)

Ac | 062.200.71.AC |

91.30.190 (250 mm.)

Ac | 062.200.03.AC |

Monomando mural MAX

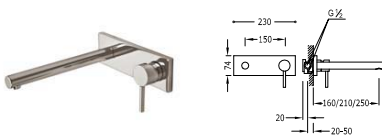

91.34.592 (210 mm.)

Ac | 062.200.02.AC |

91.34.592 (250 mm.)

Ac | 062.200.AC |

Bl-Mt | 062.200.BM |







## ESPACIO DUCHA ESPACIO BAÑERA



Block system®

**108**



Block system®

**148**



Shower technology®

**160**

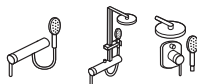

Mono-Term®

**192**



Monomandos de 3 vías

**202**



Monomandos de 2 vías

**212**



Programa de duchas

**215**

[www.tresgriferia.com](http://www.tresgriferia.com)



**RECAMBIOS**  
DE LOS ARTICULOS EN  
[www.tresgriferia.com](http://www.tresgriferia.com)





BLOCK  
SYSTEM



# ANTES DE EMPEZAR...

¿Cuántas vías de salida del agua deseas?

1 vía

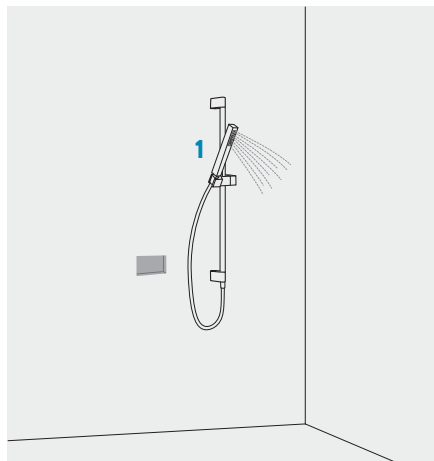

2 vías

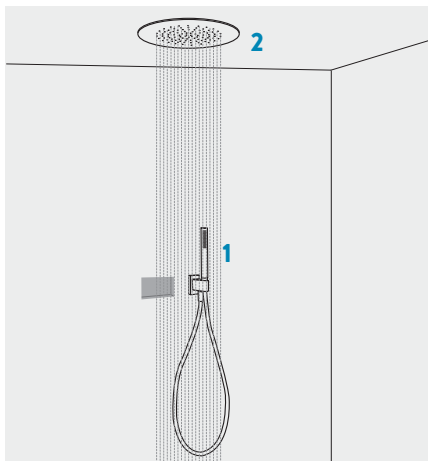

3 vías

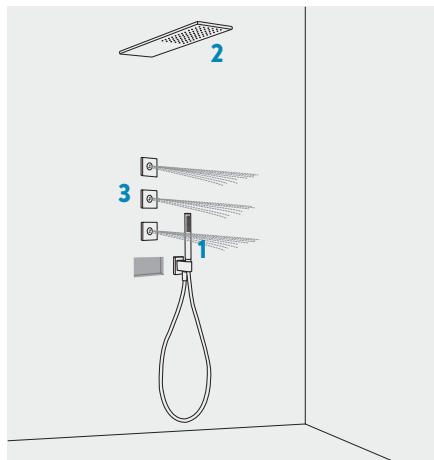

4 vías

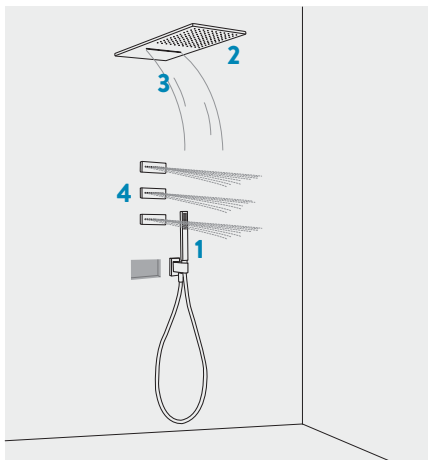

Las ilustraciones son a modo de ejemplo. Existen múltiples combinaciones de vías de salida del agua.

## Elección del sistema de control



DE 1 A 4 VÍAS

### Block system®

Termostática empotrada de gran simplicidad y belleza, con volante de temperatura preciso y volante/s para el control del caudal.

en la página 108



DE 2 A 4 VÍAS

### Shower technology®

Control electrónico termostático que regula la temperatura y las diferentes salidas del agua digitalmente, con solo un toque.

en la página 160



1 Y 2 VÍAS

### Mono-term®

El manejo es como el de los monomandos pero ofrece unas prestaciones similares a las de una termostática.

en la página 192



2 Y 3 VÍAS

### Monomando

Con el movimiento de un solo mando, controla la temperatura y caudal, y el selector de funciones ofrece hasta tres salidas de agua.

en la página 202

### Termostáticas empotradas que marcan tendencia

---



**Termostática empotrada de alto nivel estético.**  
Se suministra completamente montado de fábrica.

---

**Cartuchos distribuidores integrados de 1 a 4 vías.**  
A partir de 3 vías, posibilidad de usar dos vías simultáneas.

---

Cartucho termostático **tres instant 57®**, de difícil obstrucción, alta durabilidad y con protección anticalcárea.

---

**Fácil instalación y alineación de los elementos.**

Si el control y el soporte de ducha se compran por individual, éstos pueden alinearse fácilmente o bien instalarlos por separado. Los jets de hidromasaje (si los hay) se pueden alinear con el resto del cuerpo empotrado gracias a los perfiles de instalación.

En los kits, el control y el soporte de ducha están integrados en un solo cuerpo empotrado no divisible.



block system® horizontal

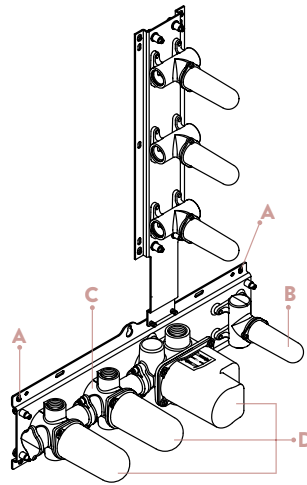

block system® vertical

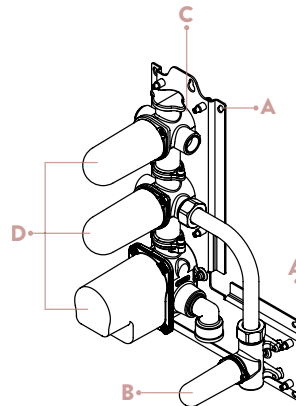

- A Perfil de instalación a muro o pladur con 3 ejes de nivelación.
- B Soporte con toma de ducha integrado.
- C Amortiguadores anti-vibración.
- D Protectores estancos. La pared queda protegida de humedad.

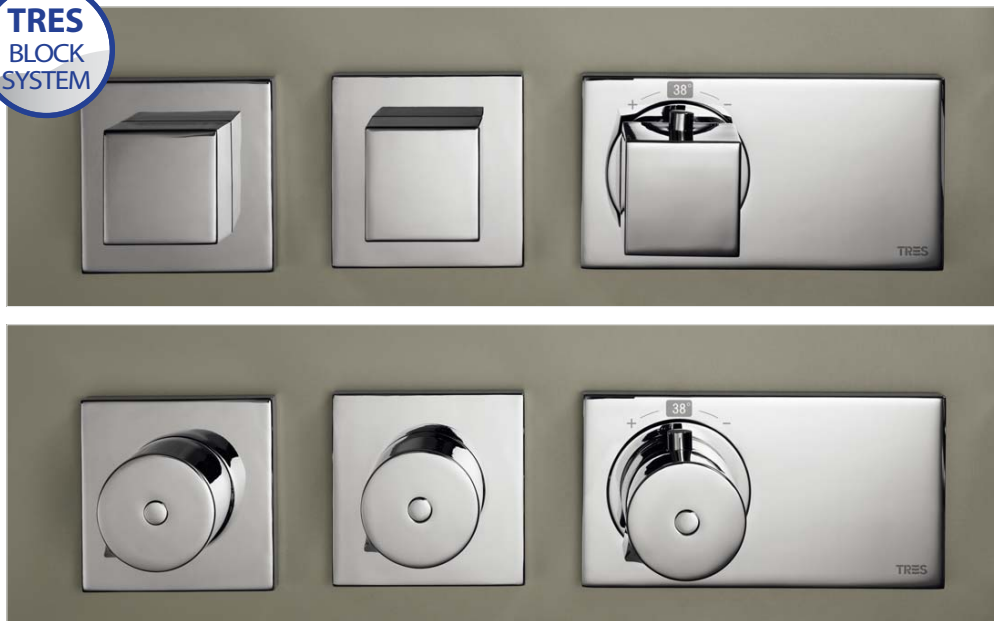

Ref:

PARA 1-2 VÍAS

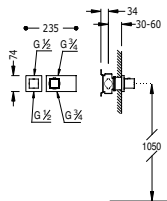

**Termostática empotrar BLOCK SYSTEM**

con cierre y regulación de caudal.

- Cuerpo empotrado termostático incluido.

\* NOTA: Es obligatorio añadir en el pedido un rociador, ducha de mano, jets o un caño bañera, dependiendo del tipo de instalación.



299.250.45

1 vía

Cr **\*207.251.99**



299.250.45

2 vías

Cr **\*207.252.99**

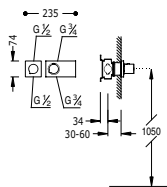

**Termostática empotrar BLOCK SYSTEM**

con cierre y regulación de caudal.

- Cuerpo empotrado termostático incluido.

\* NOTA: Es obligatorio añadir en el pedido un rociador, ducha de mano, jets o un caño bañera, dependiendo del tipo de instalación.



299.195.03

1 vía

Cr **\*207.351.99**



299.195.03

2 vías

Cr **\*207.352.99**





**Termostática empotrar BLOCK SYSTEM**

con cierre y regulación de caudal.

- Cuerpo empotrado termostático incluido.

\* NOTA: Es obligatorio añadir en el pedido un rociador, ducha de mano, jets o un caño bañera, dependiendo del tipo de instalación.

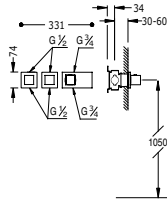

299.250.45

3 vías

Cr | \*207.253.99 |



299.250.45

4 vías

Cr | \*207.254.99 |



**Termostática empotrar BLOCK SYSTEM**

con cierre y regulación de caudal.

- Cuerpo empotrado termostático incluido.

\* NOTA: Es obligatorio añadir en el pedido un rociador, ducha de mano, jets o un caño bañera, dependiendo del tipo de instalación.

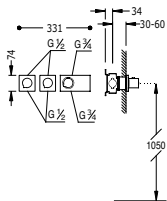

299.195.03

3 vías

Cr | \*207.353.99 |



299.195.03

4 vías

Cr | \*207.354.99 |



**N**

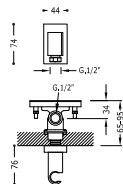

**Soporte para ducha BLOCK SYSTEM**

con toma de agua a pared regulable en profundidad, válvula antirretorno, cuerpo empotrado incluido y perfil de instalación.

Cr | 207.182.02 |

PARA 1-2 VÍAS

Ref:

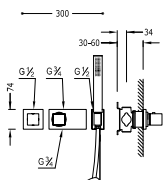

**Termostática empotrar BLOCK SYSTEM**

con cierre y regulación de caudal.

- Cuerpo empotrado termostático incluido.

- Ducha móvil anticalcárea (202.639.01).

- Flexo SATIN (91.34.609.15).

\* NOTA: Es obligatorio añadir en el pedido unos jets o un caño bañera, dependiendo del tipo de instalación.



299.250.45

1 vía

Cr 207.251.91



299.250.45

2 vías

Cr \*207.252.91

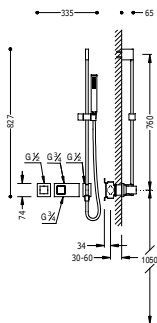

**Termostática empotrar BLOCK SYSTEM**

con cierre y regulación de caudal.

- Cuerpo empotrado termostático incluido.

- Barra deslizante con toma de agua a pared. Long 760 mm.

- Ducha móvil anticalcárea (202.639.01).

- Flexo SATIN (91.34.609.15).

\* NOTA: Es obligatorio añadir en el pedido un rociador, jets o un caño bañera, dependiendo del tipo de instalación.



299.250.45

1 vía

Cr 207.251.92



299.250.45

2 vías

Cr \*207.252.92



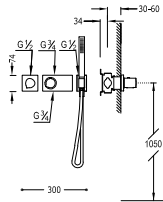

**Termostática empotrar BLOCK SYSTEM**

con cierre y regulación de caudal.  
- Cuerpo empotrado termostático incluido.  
- Ducha móvil anticalcárea (034.116.01).  
- Flexo SATIN (91.34.609.15).

\* NOTA: Es obligatorio añadir en el pedido un rociador, jets o un caño bañera, dependiendo del tipo de instalación.



299.195.03

1 vía

Cr | \*207.351.91 |



299.195.03

2 vías

Cr | \*207.352.91 |

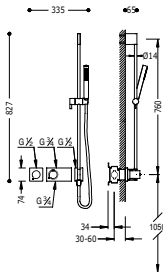

**Termostática empotrar BLOCK SYSTEM**

con cierre y regulación de caudal.  
- Cuerpo empotrado termostático incluido.  
- Barra deslizante con toma de agua a pared. Long 760 mm.  
- Ducha móvil anticalcárea (034.116.01).  
- Flexo SATIN (91.34.609.15).

\* NOTA: Es obligatorio añadir en el pedido un rociador, jets o un caño bañera, dependiendo del tipo de instalación.



299.195.03

1 vía

Cr | \*207.351.92 |



299.195.03

2 vías

Cr | \*207.352.92 |



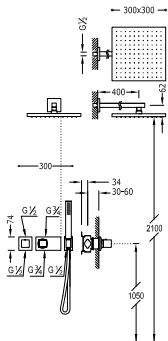

**Kit de ducha termostático empotrado BLOCK SYSTEM**

- con cierre y regulación de caudal (2 vías).
- Cuerpo empotrado termostático incluido.
- Ducha fija 300x300 mm. con rótula (1.34.138.30). Material Latón.
- Ducha móvil anticalcárea (202.639.01).
- Flexo SATIN (91.34.609.15).



Cr | 207.252.01

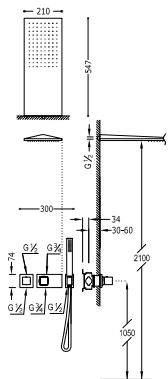

**Kit de ducha termostático empotrado BLOCK SYSTEM**

- con cierre y regulación de caudal (2 vías).
- Cuerpo empotrado termostático incluido.
- Rociador ducha INOX a pared 210x550 mm. (299.903.02).
- Ducha móvil anticalcárea (202.639.01).
- Flexo SATIN (91.34.609.15).



Cr | 207.252.02

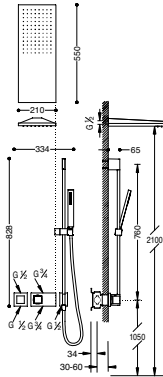

**Kit de ducha termostático empotrado BLOCK SYSTEM**

- con cierre y regulación de caudal (2 vías).
- Cuerpo empotrado termostático incluido.
- Rociador ducha INOX a pared 210x550 mm. (299.903.02).
- Barra deslizante con toma de agua a pared. Long 760 mm.
- Ducha móvil anticalcárea (202.639.01).
- Flexo SATIN (91.34.609.15).

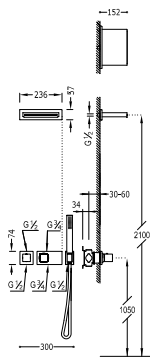

**Kit de ducha termostático empotrado BLOCK SYSTEM**

- con cierre y regulación de caudal (2 vías).
- Cuerpo empotrado termostático incluido.
- Caño cascada INOX (299.903.04).
- Ducha móvil anticalcárea (202.639.01).
- Flexo SATIN (91.34.609.15).



299.250.45

Cr | **207.252.10** |



299.250.45

Cr | **207.252.03** |

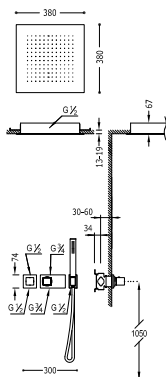

**Kit de ducha termostático empotrado BLOCK SYSTEM**

- con cierre y regulación de caudal (2 vías).
- Cuerpo empotrado termostático incluido.
- Rociador ducha INOX a techo 380x380 mm. (1.34.944).
- Ducha móvil anticalcárea (202.639.01).
- Flexo SATIN (91.34.609.15).



299.250.45

Cr 207.252.04

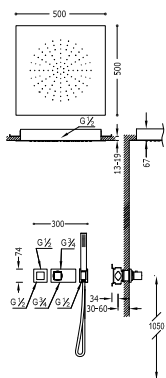

**Kit de ducha termostático empotrado BLOCK SYSTEM**

- con cierre y regulación de caudal (2 vías).
- Cuerpo empotrado termostático incluido.
- Rociador ducha INOX a techo 500x500 mm. (299.953.02).
- Ducha móvil anticalcárea (202.639.01).
- Flexo SATIN (91.34.609.15).



299.250.45

Cr 207.252.08





**Kit de ducha termostático empotrado BLOCK SYSTEM**

- con cierre y regulación de caudal (2 vías).
- Cuerpo empotrado termostático incluido.
- Rociador ducha INOX a techo 500x500 mm. (299.953.02).
- Barra deslizante con toma de agua a pared. Long 760 mm.
- Ducha móvil anticalcárea (202.639.01).
- Flexo SATIN (91.34.609.15).

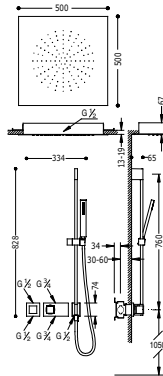

299.250.45

Cr | **207.252.09** |



**Kit de ducha termostático empotrado BLOCK SYSTEM CROMOTERAPIA**

- con cierre y regulación de caudal (2 vías).
- Cuerpo empotrado termostático incluido.
- Rociador ducha INOX a techo 500x500 mm. (299.962.01).
- Ducha móvil anticalcárea (202.639.01).
- Flexo SATIN (91.34.609.15).

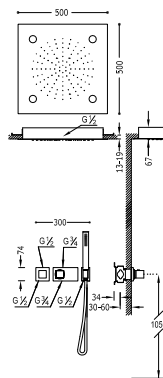

299.250.45

Cr | **207.252.05** |



### Kit de bañera termostático empotrado BLOCK SYSTEM

- con cierre y regulación de caudal (2 vías).
- Cuerpo empotrado termostático incluido.
- Caño cascada INOX.
- Ducha móvil anticalcárea (202.639.01).
- Flexo SATIN (91.34.609.15).

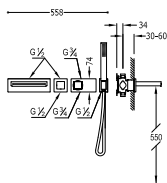

Cr 207.192.01

### Kit de bañera termostático empotrado BLOCK SYSTEM

- con cierre y regulación de caudal (2 vías).
- Cuerpo empotrado termostático incluido.
- Desagüe bañera y válvula de llenado cuadrada CASCADA con rebosadero (1.34.534.40).
- Sifón PVC bañera (1.34.634.60).
- Ducha móvil anticalcárea (202.639.01).
- Flexo SATIN (91.34.609).

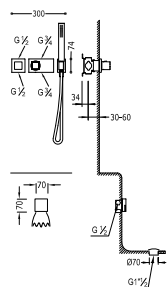

Cr 207.252.06



**Kit de bañera termostático empotrado BLOCK SYSTEM**

- con cierre y regulación de caudal (2 vías).
- Cuerpo empotrado termostático incluido.
- Desagüe bañera y válvula de llenado cuadrada CASCADA con rebosadero (1.34.534.40).
- Sifón PVC bañera (1.34.634.60).
- Ducha móvil anticalcárea (202.639.01).
- Flexo doble engatillado.

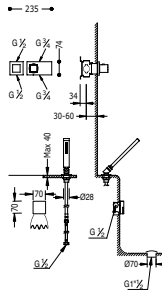

299.250.45

Cr | 207.252.07

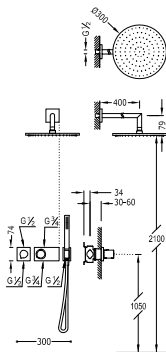

**Kit de ducha termostático empotrado BLOCK SYSTEM**

- con cierre y regulación de caudal (2 vías).
- Cuerpo empotrado termostático incluido.
- Ducha fija Ø 300 mm. con rótula. Material Latón (1.34.137.30).
- Ducha móvil anticalcárea (034.116.01).
- Flexo SATIN (91.34.609.15).

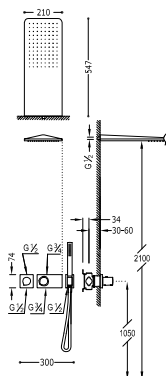

**Kit de ducha termostático empotrado BLOCK SYSTEM**

- con cierre y regulación de caudal (2 vías).
- Cuerpo empotrado termostático incluido.
- Rociador ducha INOX a pared 210x550 mm. (299.903.07).
- Ducha móvil anticalcárea (034.116.01).
- Flexo SATIN (91.34.609.15).

Cr **207.352.01**

Cr **207.352.02**



**Kit de ducha termostático empotrado BLOCK SYSTEM**

- con cierre y regulación de caudal (2 vías).
- Cuerpo empotrado termostático incluido.
- Rociador ducha INOX a pared 210x550 mm. (299.903.07).
- Barra deslizante con toma de agua a pared. Long 760 mm.
- Ducha móvil anticalcárea (034.116.01).
- Flexo SATIN (91.34.609.15).

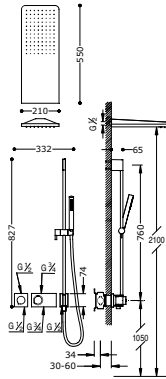

299.195.03

Cr | **207.352.10** |



**Kit de ducha termostático empotrado BLOCK SYSTEM**

- con cierre y regulación de caudal (2 vías).
- Cuerpo empotrado termostático incluido.
- Caño cascada INOX (299.903.04).
- Ducha móvil anticalcárea (034.116.01).
- Flexo SATIN (91.34.609.15).

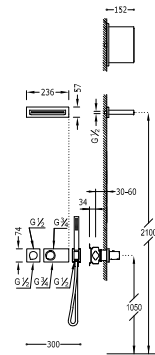

299.195.03

Cr | **207.352.03** |

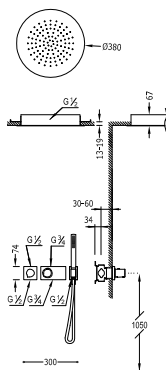

#### Kit de ducha termostático empotrado BLOCK SYSTEM

- con cierre y regulación de caudal (2 vías).
- Cuerpo empotrado termostático incluido.
- Rociador ducha INOX a techo Ø 380 mm. (1.34.940).
- Ducha móvil anticalcárea (034.116.01).
- Flexo SATIN (91.34.609.15).

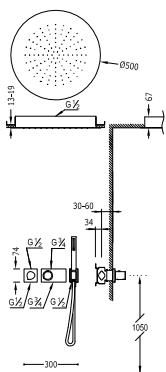

#### Kit de ducha termostático empotrado BLOCK SYSTEM

- con cierre y regulación de caudal (2 vías).
- Cuerpo empotrado termostático incluido.
- Rociador ducha INOX a techo Ø 500 mm. (1.34.950).
- Ducha móvil anticalcárea (034.116.01).
- Flexo SATIN (91.34.609.15).



299.195.03

Cr 207.352.04



299.195.03

Cr 207.352.11



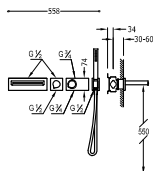

**Kit de bañera termostático empotrado BLOCK SYSTEM**

- con cierre y regulación de caudal (2 vías).
- Cuerpo empotrado termostático incluido.
- Caño cascada INOX.
- Ducha móvil anticalcárea (034.116.01).
- Flexo SATIN (91.34.609.15).



299.195.03

Cr 207.392.01

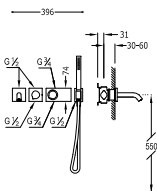

**Kit de bañera termostático empotrado BLOCK SYSTEM**

- con cierre y regulación de caudal (2 vías).
- Cuerpo empotrado termostático incluido.
- Caño bañera.
- Ducha móvil anticalcárea (034.116.01).
- Flexo SATIN (91.34.609.15).



299.195.03

Cr 207.352.09



**Kit de bañera termostático empotrado BLOCK SYSTEM**

- con cierre y regulación de caudal (2 vías).
- Cuerpo empotrado termostático incluido.
- Caño bañera.
- Ducha móvil anticálcarea (034.116.01).
- Flexo SATIN (91.34.609.15).

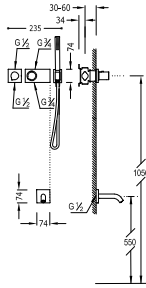

Cr | **207.352.08**

**Kit de bañera termostático empotrado BLOCK SYSTEM**

- con cierre y regulación de caudal (2 vías).
- Cuerpo empotrado termostático incluido.
- Desagüe bañera y válvula de llenado redonda CASCADA con rebosadero (1.34.534.30).
- Sifón PVC bañera (1.34.634.60).
- Ducha móvil anticálcarea (034.116.01).
- Flexo SATIN (91.34.609).

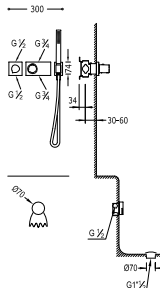

Cr | **207.352.06**

**Kit de bañera termostático empotrado BLOCK SYSTEM**

- con cierre y regulación de caudal (2 vías).
- Cuerpo empotrado termostático incluido.
- Desagüe bañera y válvula de llenado redonda CASCADA con rebosadero (1.34.534.30).
- Sifón PVC bañera (1.34.634.60).
- Ducha masaje, 5 posiciones. (299.631.06).
- Flexo doble engatillado.

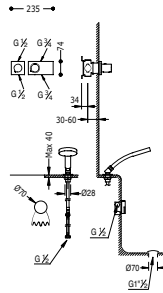

299.195.03

Cr | 207.352.07



PARA 3-4 VÍAS

Ref.:

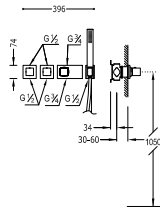

**Termostática empotrar BLOCK SYSTEM**

- con cierre y regulación de caudal.
- Cuerpo empotrado termostático incluido.
- Ducha móvil anticalcárea (202.639.01).
- Flexo SATIN (91.34.609.15).

NOTA: Es obligatorio añadir en el pedido unos jets o un caño bañera, dependiendo del tipo de instalación.

299.250.45	3 vías
Cr	207.253.91

299.250.45	4 vías
Cr	207.254.91

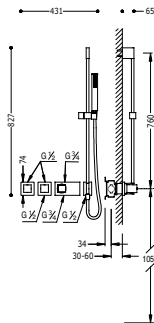

**Termostática empotrar BLOCK SYSTEM**

- con cierre y regulación de caudal.
- Cuerpo empotrado termostático incluido.
- Barra deslizante con toma de agua a pared. Long 760 mm.
- Ducha móvil anticalcárea (202.639.01).
- Flexo SATIN (91.34.609.15).

NOTA: Es obligatorio añadir en el pedido unos jets o un caño bañera, dependiendo del tipo de instalación.

299.250.45	3 vías
Cr	207.253.92

299.250.45	4 vías
Cr	207.254.92



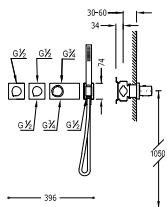

**Termostática empotrar BLOCK SYSTEM**

- con cierre y regulación de caudal.
- Cuerpo empotrado termostático incluido.
- Ducha móvil anticalcárea (034.116.01).
- Flexo SATIN (91.34.609.15).

NOTA: Es obligatorio añadir en el pedido unos jets o un caño bañera, dependiendo del tipo de instalación.



299.195.03

3 vías

Cr **207.353.91**



299.195.03

4 vías

Cr **207.354.91**

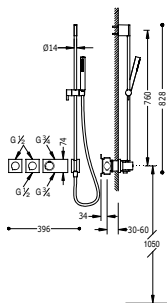

**Termostática empotrar BLOCK SYSTEM**

- con cierre y regulación de caudal.
- Cuerpo empotrado termostático incluido.
- Barra deslizante con toma de agua a pared. Long 760 mm.
- Ducha móvil anticalcárea (034.116.01).
- Flexo SATIN (91.34.609.15).

NOTA: Es obligatorio añadir en el pedido unos jets o un caño bañera, dependiendo del tipo de instalación.



299.195.03

3 vías

Cr **207.353.92**



299.195.03

4 vías

Cr **207.354.92**



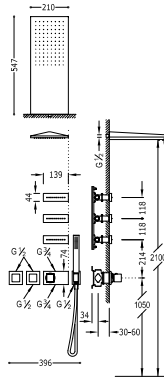

**Kit de ducha termostático empotrado BLOCK SYSTEM**

- con cierre y regulación de caudal (3 vías).
- Cuerpo empotrado termostático incluido.
- Rociador ducha INOX a pared 210x550 mm. (299.903.02).
- 3 jets antical.
- Ducha móvil anticalcárea (202.639.01).
- Flexo SATIN (91.34.609.15).

IMPORTANTE: Montar un desagüe de >50 l/min.



299.250.45

Cr | 207.253.01

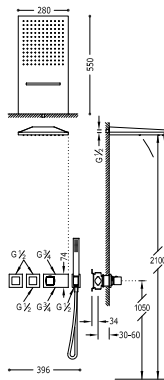

**Kit de ducha termostático empotrado BLOCK SYSTEM**

- con cierre y regulación de caudal (3 vías).
- Cuerpo empotrado termostático incluido.
- Rociador ducha INOX a pared con cascada 280x550 mm. 2 funciones (299.903.01).
- Ducha móvil anticalcárea (202.639.01).
- Flexo SATIN (91.34.609.15).

IMPORTANTE: Montar un desagüe de >50 l/min.



299.250.45

Cr | 207.253.02

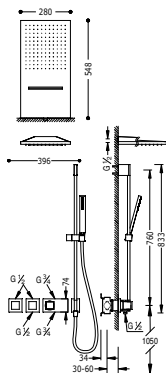

**Kit de ducha termostático empotrado BLOCK SYSTEM**

- con cierre y regulación de caudal (3 vías).
- Cuerpo empotrado termostático incluido.
- Rociador ducha INOX a pared con cascada 280x550 mm. 2 funciones (299.903.01).
- Barra deslizante con toma de agua a pared. Long 760 mm.
- Ducha móvil anticálarea (202.639.01).
- Flexo SATIN (91.34.609.15).

IMPORTANTE: Montar un desagüe de >50 l/min.

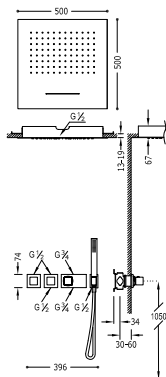

**Kit de ducha termostático empotrado BLOCK SYSTEM**

- con cierre y regulación de caudal (3 vías).
- Cuerpo empotrado termostático incluido.
- Ducha INOX con cascada 500x500 mm. 2 funciones (299.955.01).
- Ducha móvil anticálarea (202.639.01).
- Flexo SATIN (91.34.609.15).

IMPORTANTE: Montar un desagüe de >50 l/min.



299.250.45

Cr 207.253.09



299.250.45

Cr 207.253.03

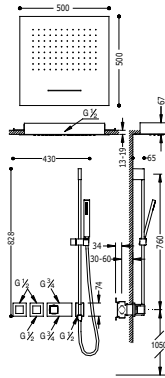

**Kit de ducha termostático empotrado BLOCK SYSTEM**

- con cierre y regulación de caudal (3 vías).
- Cuerpo empotrado termostático incluido.
- Ducha INOX con cascada 500x500 mm. 2 funciones (299.955.01).
- Barra deslizante con toma de agua a pared. Long 760 mm.
- Flexo móvil anticalcárea (202.639.01).
- Flexo SATIN (91.34.609.15).

IMPORTANTE: Montar un desagüe de >50 l/min.



299.250.45

Cr | **207.253.11** |

## INSTALACIÓN RECOMENDADA

REF. 207.253.11

Este es un esquema de instalación recomendado para aprovechar al máximo las funciones del grifo.

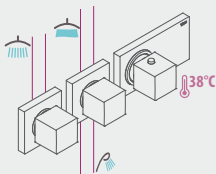

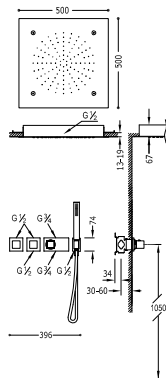
**Kit de ducha termostático empotrado BLOCK SYSTEM**

- con cierre y regulación de caudal (3 vías).
  - Cuerpo empotrado termostático incluido.
  - Ducha INOX con micro drop 500x500 mm. 2 funciones (299.954.01).
  - Ducha móvil anticalcárea (202.639.01).
  - Flexo SATIN (91.34.609.15).
- IMPORTANTE: Montar un desagüe de >50 l/min.



299.250.45

Cr 207.253.12

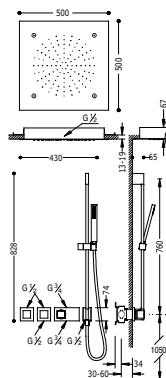
**Kit de ducha termostático empotrado BLOCK SYSTEM**

- con cierre y regulación de caudal (3 vías).
  - Cuerpo empotrado termostático incluido.
  - Ducha INOX con micro drop 500x500 mm. 2 funciones (299.954.01).
  - Barra deslizante con toma de agua a pared. Long 760 mm.
  - Ducha móvil anticalcárea (202.639.01).
  - Flexo SATIN (91.34.609.15).
- IMPORTANTE: Montar un desagüe de >50 l/min.



299.250.45

Cr 207.253.13



**Kit de ducha termostático empotrado BLOCK SYSTEM CROMOTERAPIA**

- con cierre y regulación de caudal (3 vías).
  - Cuerpo empotrado termostático incluido.
  - Rociador ducha INOX a techo 500x500 mm. (299.962.01).
  - 3 jets antical.
  - Ducha móvil anticalcárea (202.639.01).
  - Flexo SATIN (91.34.609.15).
- IMPORTANTE: Montar un desagüe de >50 l/min.

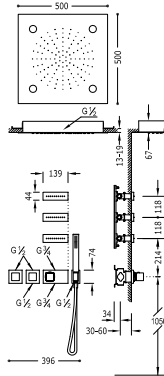

299.250.45  
Cr | **207.254.04**



**Kit de ducha termostático empotrado BLOCK SYSTEM**

- con cierre y regulación de caudal (4 vías).
  - Cuerpo empotrado termostático incluido.
  - Ducha INOX con cascada 500x500 mm. 2 funciones (299.955.01).
  - 3 jets antical.
  - Ducha móvil anticalcárea (202.639.01).
  - Flexo SATIN (91.34.609.15).
- IMPORTANTE: Montar un desagüe de >50 l/min.

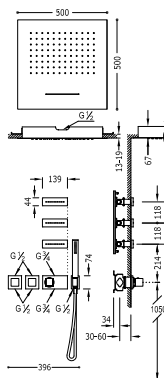

299.250.45  
Cr | **207.254.02**

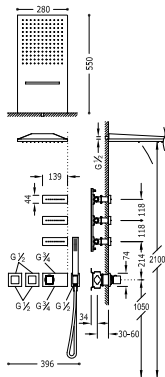

**Kit de ducha termostático empotrado BLOCK SYSTEM**

- con cierre y regulación de caudal (4 vías).
  - Cuerpo empotrado termostático incluido.
  - Rociador ducha INOX a pared con cascada 280x550 mm.
  - 2 jets antical (299.903.01).
  - 3 jets antical.
  - Ducha móvil anticalcárea (202.639.01).
  - Flexo SATIN (91.34.609.15).
- IMPORTANTE: Montar un desagüe de >50 l/min.

299.250.85  
**Cr 207.254.01**

## INSTALACIÓN RECOMENDADA

REF. 207.254.01

Este es un esquema de instalación recomendado para aprovechar al máximo las funciones del grifo.

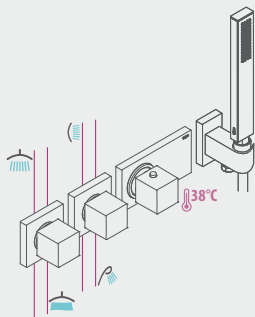



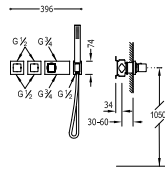
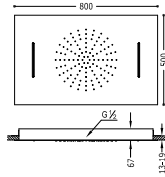

**Kit de ducha termostático empotrado BLOCK SYSTEM**

- con cierre y regulación de caudal (4 vías).
- Cuerpo empotrado termostático incluido.
- Ducha INOX con cascada 500x800 mm. 2 funciones (299.966.01).
- Ducha móvil anticálrea (202.639.01).
- Flexo SATIN (91.34.609.15).

IMPORTANTE: Montar un desagüe de >50 l/min.



Cr | 207.250.03

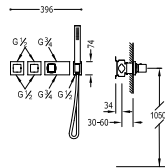
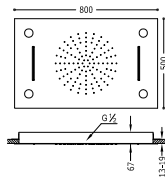

**Kit de ducha termostático empotrado BLOCK SYSTEM CROMOTERAPIA**

- con cierre y regulación de caudal (4 vías).
- Cuerpo empotrado termostático incluido.
- Ducha INOX con cascada 500x800 mm. 3 funciones (299.965.01).
- Ducha móvil anticálrea (202.639.01).
- Flexo SATIN (91.34.609.15).

IMPORTANTE: Montar un desagüe de >50 l/min.



Cr | 207.254.04

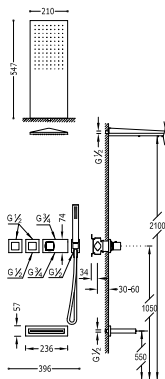

**Kit de bañera termostático empotrado BLOCK SYSTEM**

- con cierre y regulación de caudal (3 vías).
  - Cuerpo empotrado termostático incluido.
  - Rociador ducha INOX a pared 210x550 mm.
  - Caño cascada INOX.
  - Ducha móvil anticalcárea.
  - Flexo SATIN (91.34.609.15).
- IMPORTANTE: Montar un desagüe de >50 l/min.

Cr 299.250.45  
Ac 299.250.45.AC

Cr 207.253.05  
Ac 207.253.05.AC

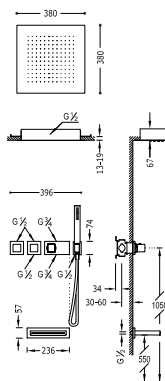

**Kit de bañera termostático empotrado BLOCK SYSTEM**

- con cierre y regulación de caudal (3 vías).
  - Cuerpo empotrado termostático incluido.
  - Rociador ducha INOX a techo 380x380 mm. (1.34.944).
  - Caño cascada INOX (299.903.04).
  - Ducha móvil anticalcárea (202.639.01).
  - Flexo SATIN (91.34.609.15).
- IMPORTANTE: Montar un desagüe de >50 l/min.

299.250.45

Cr 207.253.06





**Kit de bañera termostático empotrado BLOCK SYSTEM CROMOTERAPIA**

con cierre y regulación de caudal (3 vías).

- Cuerpo empotrado termostático incluido.
- Rociador ducha a techo 500x500 mm. (299.962.01).
- Caño cascada INOX (299.903.04).
- Ducha móvil anticalcárea (202.639.01).
- Flexo SATIN (91.34.609.15).

IMPORTANTE: Montar un desagüe de >50 l/min.

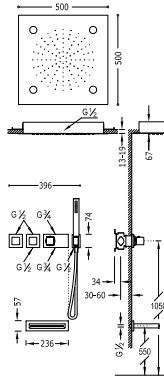

299.250.45

Cr | **207.253.07** |

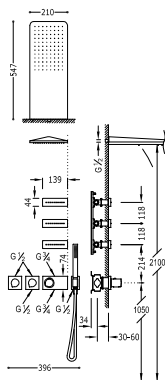

### Kit de ducha termostático empotrado BLOCK SYSTEM

- con cierre y regulación de caudal (3 vías).
- Cuerpo empotrado termostático incluido.
- Rociador ducha INOX a pared 210x550 mm. (299.903.07).
- 3 jets antical.
- Ducha móvil anticalárea (034.116.01).
- Flexo SATIN (91.34.609.15).

IMPORTANTE: Montar un desagüe de >50 l/min.



299.195.03

Cr 207.353.01

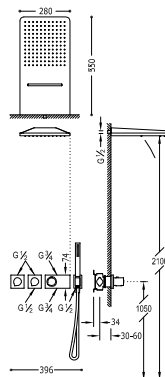

### Kit de ducha termostático empotrado BLOCK SYSTEM

- con cierre y regulación de caudal (3 vías).
- Cuerpo empotrado termostático incluido.
- Rociador ducha INOX a pared con cascada 280x550 mm. 2 funciones (299.903.08).
- Ducha móvil anticalárea (034.116.01).
- Flexo SATIN (91.34.609.15).

IMPORTANTE: Montar un desagüe de >50 l/min.



299.195.03

Cr 207.353.02

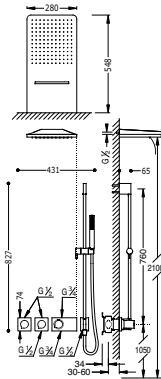

**Kit de ducha termostático empotrado BLOCK SYSTEM**

- con cierre y regulación de caudal (3 vías).
  - Cuerpo empotrado termostático incluido.
  - Rociador ducha INOX a pared con cascada 280x550 mm.
  - 2 funciones (299.903.08).
  - Barra deslizante con toma de agua a pared. Long 760 mm.
  - Ducha móvil anticálcarea (034.116.01).
  - Flexo SATIN (91.34.609.15).
- IMPORTANTE: Montar un desagüe de >50 l/min.



299.195.03

Cr | 207.353.09

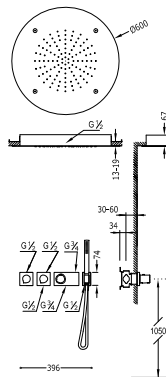

**Kit de ducha termostático empotrado BLOCK SYSTEM**

- con cierre y regulación de caudal (3 vías).
  - Cuerpo empotrado termostático incluido.
  - Ducha INOX con micro drop Ø 600 mm. 2 funciones (299.956.01).
  - Ducha móvil anticálcarea (034.116.01).
  - Flexo SATIN (91.34.609.15).
- IMPORTANTE: Montar un desagüe de >50 l/min.



299.195.03

Cr | 207.353.10

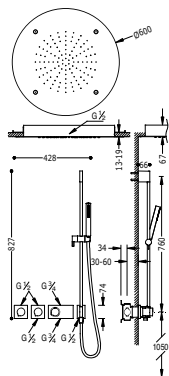

**Kit de ducha termostático empotrado BLOCK SYSTEM**

- con cierre y regulación de caudal (3 vías).
- Cuerpo empotrado termostático incluido.
- Ducha INOX con micro drop Ø 600 mm. 2 funciones (299.956.01).
- Barra deslizante con toma de agua a pared. Long 760 mm.
- Ducha móvil anticalcárea (034.116.01).
- Flexo SATIN (91.34.609.15).

IMPORTANTE: Montar un desagüe de >50 l/min.



299.195.03

Cr 207.353.11

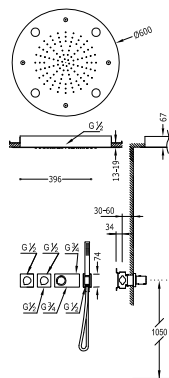

**Kit de ducha termostático empotrado BLOCK SYSTEM CROMOTERAPIA**

- con cierre y regulación de caudal (3 vías).
- Cuerpo empotrado termostático incluido.
- Ducha INOX con micro drop Ø 600 mm. 3 funciones (299.958.01).
- Ducha móvil anticalcárea (034.116.01).
- Flexo SATIN (91.34.609.15).

IMPORTANTE: Montar un desagüe de >50 l/min.



299.195.03

Cr 207.353.12



**Kit de ducha termostático empotrado BLOCK SYSTEM**

- con cierre y regulación de caudal (3 vías).
  - Cuerpo empotrado termostático incluido.
  - Ducha INOX con cascada 500x500 mm. 2 funciones (299.955.01).
  - Ducha móvil anticalcárea (034.116.01).
  - Flexo SATIN (91.34.609.15).
- IMPORTANTE: Montar un desagüe de >50 l/min.

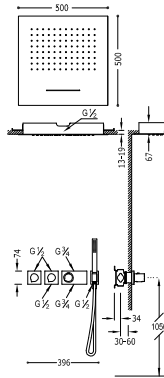

299.125.03

Cr | **207.353.03** |



**Kit de ducha termostático empotrado BLOCK SYSTEM CROMOTERAPIA**

- con cierre y regulación de caudal (3 vías).
  - Cuerpo empotrado termostático incluido.
  - Rociador ducha INOX a techo 500x500 mm. (299.962.01).
  - 3 jets antical.
  - Ducha móvil anticalcárea (034.116.01).
  - Flexo SATIN (91.34.609.15).
- IMPORTANTE: Montar un desagüe de >50 l/min.

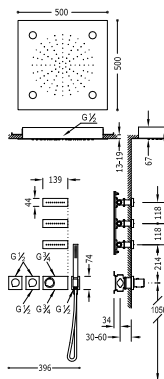

299.125.03

Cr | **207.353.04** |

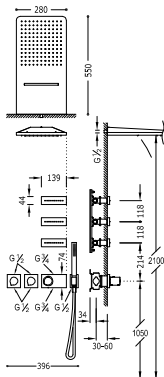

**Kit de ducha termostático empotrado BLOCK SYSTEM**

- con cierre y regulación de caudal (4 vías).
- Cuerpo empotrado termostático incluido.
- Rociador ducha INOX a pared con cascada 280x550 mm.
- 2 funciones (299.903.08).
- 3 jets antical.
- Ducha móvil anticálcarea (034.116.01).
- Flexo SATIN (91.34.609.15).

IMPORTANTE: Montar un desagüe de >50 l/min.



299.195.03

Cr 207.354.01

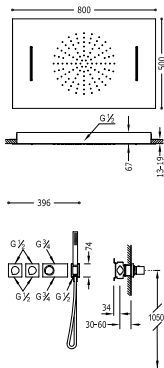

**Kit de ducha termostático empotrado BLOCK SYSTEM**

- con cierre y regulación de caudal (4 vías).
- Cuerpo empotrado termostático incluido.
- Ducha INOX con cascada 500x800 mm. 2 funciones (299.966.01).
- Ducha móvil anticálcarea (034.116.01).
- Flexo SATIN (91.34.609.15).

IMPORTANTE: Montar un desagüe de >50 l/min.



299.195.03

Cr 207.354.03





**Kit de ducha termostático empotrado BLOCK SYSTEM CROMOTERAPIA**

- con cierre y regulación de caudal (4 vías).
  - Cuerpo empotrado termostático incluido.
  - Ducha INOX con cascada 500x800 mm. 3 funciones (299.965.01).
  - Ducha móvil anticalcárea (034.116.01).
  - Flexo SATIN (91.34.609.15).
- IMPORTANTE: Montar un desagüe de >50 l/min.

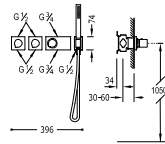
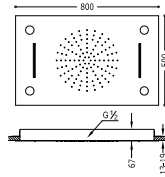

299.195.03

Cr | **207.354.04** |

**INSTALACIÓN RECOMENDADA**

REF. 207.354.04

Este es un esquema de instalación recomendado para aprovechar al máximo las funciones del grifo.

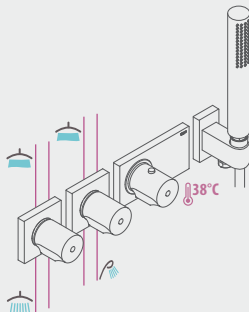

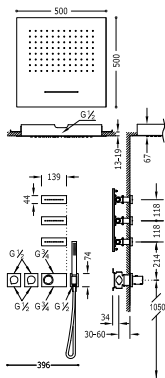

**Kit de ducha termostático empotrado BLOCK SYSTEM**

- con cierre y regulación de caudal (4 vías).
- Cuerpo empotrado termostático incluido.
- Ducha INOX con cascada 500x500 mm. 2 funciones (299.955.01).
- 3 jets antical.
- Ducha móvil anticalcárea (034.116.01).
- Flexo SATIN (91.34.609.15).

IMPORTANTE: Montar un desagüe de >50 l/min.



299.195.03

Cr 207.354.02

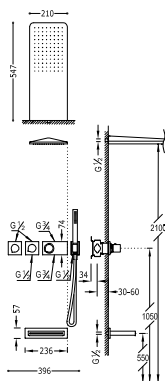

**Kit de bañera termostático empotrado BLOCK SYSTEM**

- con cierre y regulación de caudal (3 vías).
- Cuerpo empotrado termostático incluido.
- Rociador ducha INOX a pared 210x550 mm. (299.903.07).
- Caño cascada INOX (299.903.04).
- Ducha móvil anticalcárea (034.116.01).
- Flexo SATIN (91.34.609.15).

IMPORTANTE: Montar un desagüe de >50 l/min.



299.195.03

Cr 207.353.05

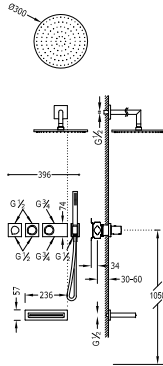

**Kit de bañera termostático empotrado BLOCK SYSTEM**

- con cierre y regulación de caudal (3 vías).
  - Cuerpo empotrado termostático incluido.
  - Ducha fija Ø 300 mm. con rótula. Material Latón.
  - Caño cascada INOX.
  - Ducha móvil anticalcárea.
  - Flexo SATIN (91.34.609.15).
- IMPORTANTE: Montar un desagüe de >50 l/min.

Cr 299.195.03  
Ac 299.195.03.AC

Cr **207.353.08**  
Ac **207.353.08.AC**

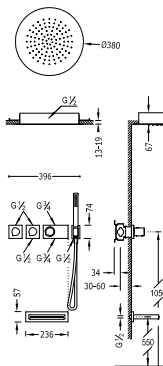

**Kit de bañera termostático empotrado BLOCK SYSTEM**

- con cierre y regulación de caudal (3 vías).
  - Cuerpo empotrado termostático incluido.
  - Rociador ducha INOX a techo Ø 380 mm. (1.34.940).
  - Caño cascada INOX (299.903.04).
  - Ducha móvil anticalcárea (034.116.01).
  - Flexo SATIN (91.34.609.15).
- IMPORTANTE: Montar un desagüe de >50 l/min.

299.195.03

Cr **207.353.06**





**Kit de bañera termostático empotrado BLOCK SYSTEM CROMOTERAPIA**

- con cierre y regulación de caudal (3 vías).
  - Cuerpo empotrado termostático incluido.
  - Rociador ducha INOX a techo 500x500 mm. (299.962.01).
  - Caño cascada INOX (299.903.04).
  - Ducha móvil anticálarea (034.116.01).
  - Flexo SATIN (91.34.609.15).
- IMPORTANTE: Montar un desagüe de >50 l/min.

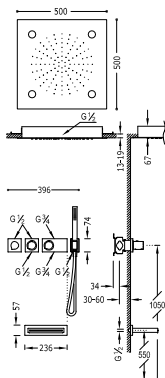

299.195.03  
**Cr 207.353.07**

## INSTALACIÓN RECOMENDADA

REF. 207.353.07

Este es un esquema de instalación recomendado para aprovechar al máximo las funciones del grifo.

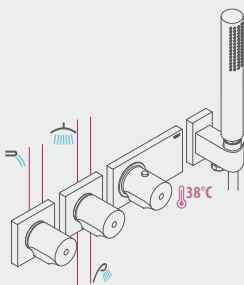



TRES  
BLOCK  
SYSTEM



Ref:

N

### Termostática empotrar BLOCK SYSTEM

con cierre y regulación de caudal.

· Cuerpo empotrado termostático incluido.

\* NOTA: Es obligatorio añadir en el pedido un rociador, ducha de mano, jets o un caño bañera, dependiendo del tipo de instalación.

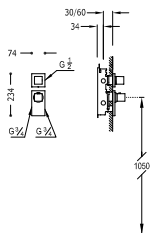

299.250.45

1 vía

Cr 206.251.99



299.250.45

2 vías

Cr \*206.252.99



PARA 1-2 VÍAS

N

### Termostática empotrar BLOCK SYSTEM

con cierre y regulación de caudal.

· Cuerpo empotrado termostático incluido.

\* NOTA: Es obligatorio añadir en el pedido un rociador, ducha de mano, jets o un caño bañera, dependiendo del tipo de instalación.

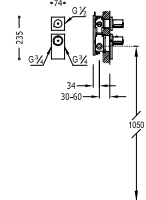

299.250.45

1 vía

Cr 206.351.99



299.250.45

2 vías

Cr \*206.352.99



**N**

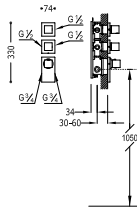

**Termostática empotrar BLOCK SYSTEM**

con cierre y regulación de caudal.

- Cuerpo empotrado termostático incluido.

\* NOTA: Es obligatorio añadir en el pedido un rociador, ducha de mano, jets o un caño bañera, dependiendo del tipo de instalación.



299.250.45

3 vías

Cr | \*206.253.99 |



299.250.45

4 vías

Cr | \*206.254.99 |

**N**

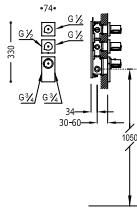

**Termostática empotrar BLOCK SYSTEM**

con cierre y regulación de caudal.

- Cuerpo empotrado termostático incluido.

\* NOTA: Es obligatorio añadir en el pedido un rociador, ducha de mano, jets o un caño bañera, dependiendo del tipo de instalación.



299.250.45

3 vías

Cr | \*206.353.99 |



299.250.45

4 vías

Cr | \*206.354.99 |

**N**

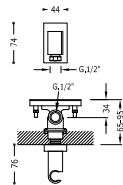

**Soporte para ducha BLOCK SYSTEM**

con toma de agua a pared regulable en profundidad, válvula antirretorno, cuerpo empotrado incluido y perfil de instalación.

Cr | 207.182.02 |

PARA 1-2 VÍAS

Ref:

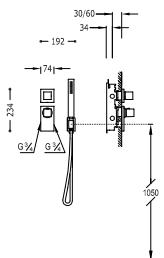

**Termostática empotrar BLOCK SYSTEM**

- con cierre y regulación de caudal.
  - Cuerpo empotrado termostático incluido.
  - Ducha móvil anticalcárea (202.639.01).
  - Flexo SATIN (91.34.609.15).
- \* NOTA: Es obligatorio añadir en el pedido un rociador, jets o un caño bañera, dependiendo del tipo de instalación.



299.250.45

1 vía

Cr **\*206.251.91**



299.250.45

2 vías

Cr **\*206.251.91**

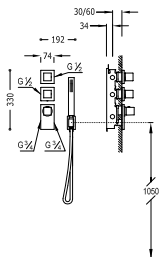

**Termostática empotrar BLOCK SYSTEM**

- con cierre y regulación de caudal.
  - Cuerpo empotrado termostático incluido.
  - Ducha móvil anticalcárea (202.639.01).
  - Flexo SATIN (91.34.609.15).
- \* NOTA: Es obligatorio añadir en el pedido un rociador, jets o un caño bañera, dependiendo del tipo de instalación.



299.250.45

3 vías

Cr **\*206.253.91**



299.250.45

4 vías

Cr **\*206.253.91**







**Termostática empotrar BLOCK SYSTEM**

- con cierre y regulación de caudal.
- Cuerpo empotrado termostático incluido
- Ducha móvil anticálcarea (034.116.01).
- Flexo SATIN (91.34.609.15).

\* NOTA: Es obligatorio añadir en el pedido un rociador, jets o un caño bañera, dependiendo del tipo de instalación.

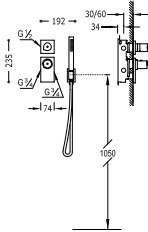

299.195.03

1 vía

Cr | \*206.351.91 |



299.195.03

2 vías

Cr | \*206.352.91 |



**Termostática empotrar BLOCK SYSTEM**

- con cierre y regulación de caudal.
- Cuerpo empotrado termostático incluido
- Ducha móvil anticálcarea (034.116.01).
- Flexo SATIN (91.34.609.15).

\* NOTA: Es obligatorio añadir en el pedido un rociador, jets o un caño bañera, dependiendo del tipo de instalación.

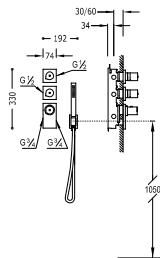

299.195.03

3 vías

Cr | \*206.353.91 |



299.195.03

4 vías

Cr | \*206.354.91 |





**Kit de ducha termostático empotrado BLOCK SYSTEM**

- con cierre y regulación de caudal (2 vías).
- Cuerpo empotrado termostático incluido.
- Ducha fija 300x300 mm. con rótula (1.34.138.30). Material Latón.
- Ducha móvil anticalcárea (202.639.01).
- Flexo SATIN (91.34.609.15).

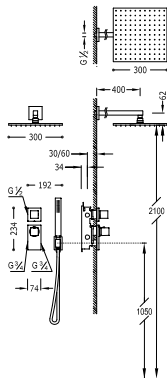

**Kit de ducha termostático empotrado BLOCK SYSTEM**

- con cierre y regulación de caudal (2 vías).
- Cuerpo empotrado termostático incluido.
- Rociador ducha INOX a pared 160x550 mm. (299.903.03).
- Ducha móvil anticalcárea (202.639.01).
- Flexo SATIN (91.34.609.15).

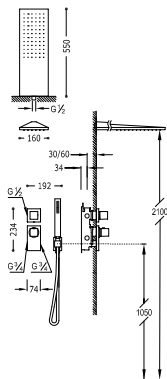

299.250.45

Cr 206.252.01



299.250.45

Cr 206.252.02

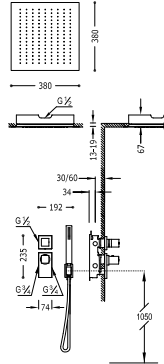

**Kit de ducha termostático empotrado BLOCK SYSTEM**

- con cierre y regulación de caudal (2 vías).
- Cuerpo empotrado termostático incluido.
- Rociador ducha INOX a techo 380x380 mm. (1.34.944).
- Ducha móvil anticálrea (202.639.01).
- Flexo SATIN (91.34.609.15).



Cr | **206.252.04** |

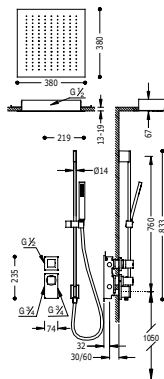

**Kit de ducha termostático empotrado BLOCK SYSTEM**

- con cierre y regulación de caudal (2 vías).
- Cuerpo empotrado termostático incluido.
- Rociador ducha INOX a techo 380x380 mm. (1.34.944).
- Barra deslizante con toma de agua a pared. Long 760 mm
- Ducha móvil anticálrea (202.639.01).
- Flexo SATIN (91.34.609.15).



Cr | **206.252.03** |

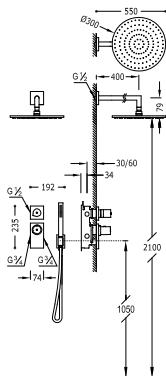

**Kit de ducha termostático empotrado BLOCK SYSTEM**

- con cierre y regulación de caudal (2 vías).
- Cuerpo empotrado termostático incluido.
- Ducha fija Ø 300 mm. con rótula. Material Latón (1.34.137.30).
- Ducha móvil anticalcárea (034.116.01).
- Flexo SATIN (91.34.609.15).



299.195.03

Cr 206.352.01

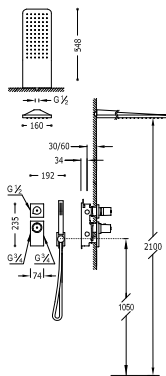

**Kit de ducha termostático empotrado BLOCK SYSTEM**

- con cierre y regulación de caudal (2 vías).
- Cuerpo empotrado termostático incluido.
- Rociador ducha INOX a pared 160x550 mm. (299.903.06).
- Ducha móvil anticalcárea (034.116.01).
- Flexo SATIN (91.34.609.15).



299.195.03

Cr 206.352.02



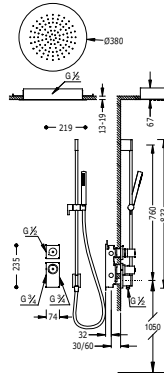

**Kit de ducha termostático empotrado BLOCK SYSTEM**

- con cierre y regulación de caudal (2 vías).
- Cuerpo empotrado termostático incluido.
- Rociador ducha INOX a techo Ø 380 mm. (1.34.940).
- Barra deslizante con toma de agua a pared. Long 760 mm.
- Ducha móvil anticalcárea (034.116.01).
- Flexo SATIN (91.34.609.15).



299.195.03

Cr | **206.352.03** |

**INSTALACIÓN  
RECOMENDADA**

REF. 206.352.03

Este es un esquema de instalación recomendado para aprovechar al máximo las funciones del grifo.

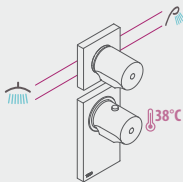



### Kit de ducha termostático empotrado BLOCK SYSTEM

- con cierre y regulación de caudal (2 vías).
- Cuerpo empotrado termostático incluido.
- Rociador ducha INOX a techo Ø 380 mm. (1.34.940).
- Ducha móvil anticalcárea (034.116.01).
- Flexo SATIN (91.34.609.15).

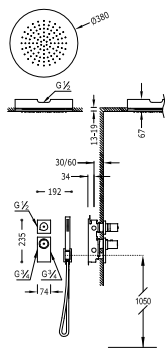

299.195.03

Cr 206.352.04

PARA 3 VÍAS

Ref.:

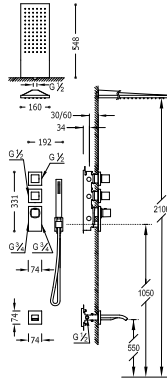

**Kit de bañera termostático empotrado BLOCK SYSTEM**

- con cierre y regulación de caudal (3 vías).
- Cuerpo empotrado termostático incluido.
- Rociador ducha INOX a pared 160x550 mm. (299.903.03).
- Caño cascada.
- Ducha móvil anticalcárea (202.639.01).
- Flexo SATIN (91.34.609.15).



299.250.45



Cr | **206.253.01**

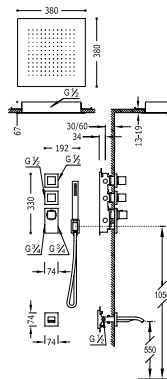

**Kit de bañera termostático empotrado BLOCK SYSTEM**

- con cierre y regulación de caudal (3 vías).
- Cuerpo empotrado termostático incluido.
- Rociador ducha INOX a techo 380x380 mm. (1.34.944).
- Caño cascada.
- Ducha móvil anticalcárea (202.639.01).
- Flexo SATIN (91.34.609.15).



299.250.45



Cr | **206.253.02**

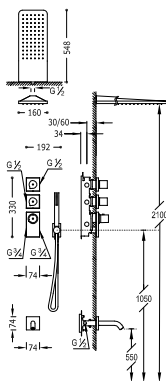

### Kit de bañera termostático empotrado BLOCK SYSTEM

- con cierre y regulación de caudal (3 vías).
- Cuerpo empotrado termostático incluido.
- Rociador ducha INOX a pared 160x550 mm. (299.903.06).
- Caño bañera.
- Ducha móvil anticalcárea (034.116.01).
- Flexo SATIN (91.34.609.15).



299.195.03

Cr 206.353.01

## INSTALACIÓN RECOMENDADA

REF. 206.353.01

Este es un esquema de instalación recomendado para aprovechar al máximo las funciones del grifo.

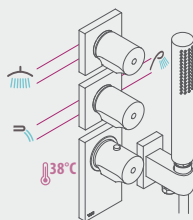





**Kit de bañera termostático empotrado BLOCK SYSTEM**

- con cierre y regulación de caudal (3 vías).
- Cuerpo empotrado termostático incluido.
- Rociador ducha INOX a techo Ø 380 mm. (1.34.940).
- Caño bañera.
- Ducha móvil anticalcárea (034.116.01).
- Flexo SATIN (91.34.609.15).

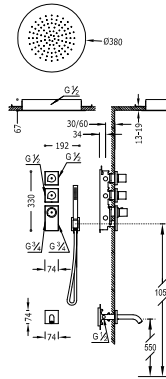

299.195.03

Cr

**206.353.02**



### El control de la ducha en un solo toque

**Mínima instalación** y montaje rápido.

---

**Centralita termostática electrónica.** Se puede instalar a 5 o 10 metros de distancia del espacio de ducha.

---

**Eficiencia.** El mezclador digital se apagará automáticamente cuando el producto esté continuamente abierto durante más de 15 minutos.

---

**Seguridad.** En caso de posibles fallos en la alimentación del agua fría, el sistema se bloquea y corta el paso del agua.

---



## Paneles digitales termostáticos

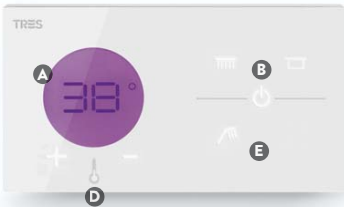

El nivel de temperatura seleccionada se indica numéricamente y en escala de colores.



**Warm System®.** La luz del panel digital parpadea mientras se está alcanzando su temperatura preseleccionada, así sabrá exactamente cuando su ducha estará a punto.

- A Pantalla de información.
- B Encendido, apagado y pausa.
- C Control de caudal.
- D Selector de temperatura.
- E Control de salida del agua.

SHOWER  
TECHNOLOGY



Ref.:

**N**

PARA 2 VIAS

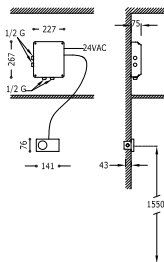
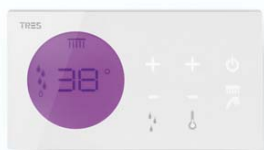

**Control termostático electrónico empotrado SHOWER TECHNOLOGY**

- Centralita termostática electrónica incluida (2 vías).

\* NOTA: Es obligatorio añadir en el pedido un rociador, ducha de mano, jets o un caño bañera, dependiendo del tipo de instalación.

BI 092.862.99

**N**

PARA 3 VIAS

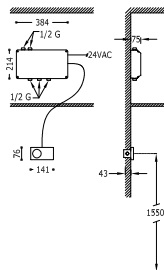
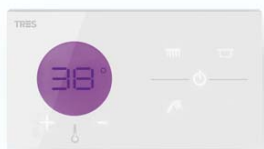

**Control termostático electrónico empotrado SHOWER TECHNOLOGY**

- Centralita termostática electrónica incluida (3 vías).

\* NOTA: Es obligatorio añadir en el pedido un rociador, ducha de mano, jets o un caño bañera, dependiendo del tipo de instalación.

BI 092.863.99

PARA 3 VIAS

**N**

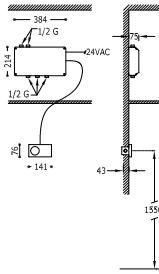
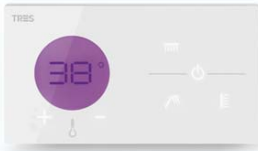

**Control termostático electrónico empotrado SHOWER TECHNOLOGY**

- Centralita termostática electrónica incluida (3 vías).  
\* NOTA: Es obligatorio añadir en el pedido un rociador, ducha de mano, jets o un caño bañera, dependiendo del tipo de instalación.

BI | 092.863.98 |

PARA 4 VIAS

**N**

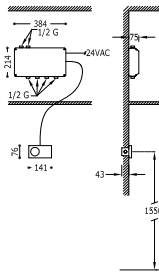
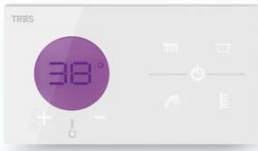

**Control termostático electrónico empotrado SHOWER TECHNOLOGY**

- Centralita termostática electrónica incluida (4 vías).  
\* NOTA: Es obligatorio añadir en el pedido un rociador, ducha de mano, jets o un caño bañera, dependiendo del tipo de instalación.

BI | 092.864.99 |

SHOWER  
TECH.



**N**

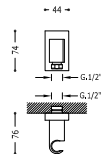

**Soporte para ducha**

con toma de agua a pared y válvula antirretorno.

Cr | 207.182.01 |

PARA 2 VÍAS

Ref:

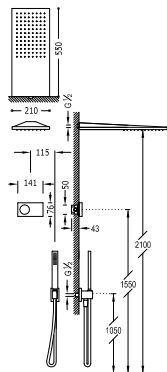

Kit electrónico de ducha termostático empotrado  
SHOWER TECHNOLOGY

- Centralita termostática electrónica incluida (2 vías).
- Rociador ducha INOX a pared 210x550 mm. (299.903.02).
- Soporte con toma pared (207.182.01).
- Ducha móvil anticalcárea (202.639.01).
- Flexo SATIN (91.34.609.15).



Cr 092.865.51

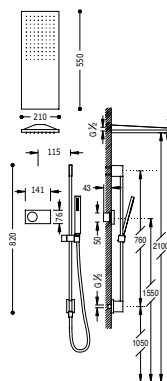

Kit electrónico de ducha termostático empotrado  
SHOWER TECHNOLOGY

- Centralita termostática electrónica incluida (2 vías).
- Rociador ducha INOX a pared 210x550 mm. (299.903.02).
- Barra deslizante con toma de agua a pared. Long 760 mm. (034.932.99).
- Ducha móvil anticalcárea (202.639.01).
- Flexo SATIN (91.34.609.15).



Cr 092.865.80

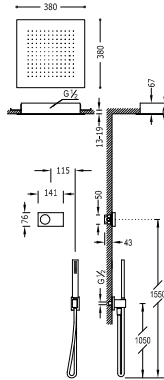

**Kit electrónico de ducha termostático empotrado  
SHOWER TECHNOLOGY**

- Centralita termostática electrónica incluida (2 vías).
- Rociador ducha INOX a techo 380x380 mm. (1.34.944).
- Soporte con toma pared (207.182.01).
- Ducha móvil anticalcárea (202.639.01).
- Flexo SATIN (91.34.609.15).



Cr | 092.865.52 |

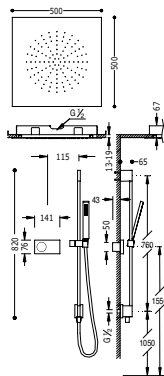

**Kit electrónico de ducha termostático empotrado  
SHOWER TECHNOLOGY**

- Centralita termostática electrónica incluida (2 vías).
- Rociador ducha INOX a techo 500x500 mm. (299.953.02).
- Barra deslizante con toma de agua a pared. Long 760 mm. (034.932.99).
- Ducha móvil anticalcárea (202.639.01).
- Flexo SATIN (91.34.609.15).



Cr | 092.865.81 |

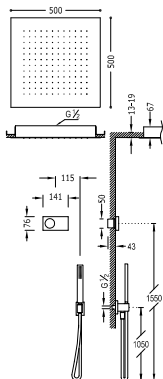

**Kit electrónico de ducha termostático empotrado  
SHOWER TECHNOLOGY**

- Centralita termostática electrónica incluida (2 vías).
- Rociador ducha INOX a techo 500x500 mm. (1.34.951).
- Soporte con toma pared (207.182.01).
- Ducha móvil anticalcárea (202.639.01).
- Flexo SATIN (91.34.609.15).



Cr 092.865.61

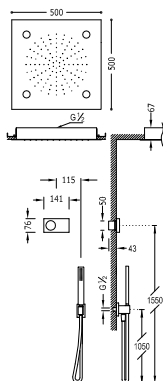

**Kit electrónico de ducha termostático empotrado  
SHOWER TECHNOLOGY con CROMOTERAPIA**

- Centralita termostática electrónica incluida (2 vías).
- Rociador ducha INOX a techo 500x500 mm. (299.962.01).
- Soporte con toma pared (207.182.01).
- Ducha móvil anticalcárea (202.639.01).
- Flexo SATIN (91.34.609.15).



Cr 092.865.62





**Kit electrónico de ducha termostático empotrado  
SHOWER TECHNOLOGY**

- Centralita termostática electrónica incluida (2 vías).
- Ducha fija 300x300 mm. con rótula. Material Latón (1.34.138.30).
- Soporte con toma pared (207.182.01).
- Ducha móvil anticalcárea (202.639.01).
- Flexo SATIN (91.34.609.15).

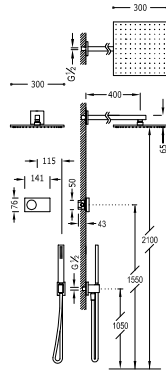

Cr | 092.865.63 |



**Kit electrónico de ducha termostático empotrado  
SHOWER TECHNOLOGY**

- Centralita termostática electrónica incluida (2 vías).
- Ducha fija 300x300 mm. con rótula. Material Latón (1.34.138.30).
- Soporte con toma pared (207.182.01).
- Ducha móvil anticalcárea (202.639.01).
- Flexo SATIN (91.34.609.15).

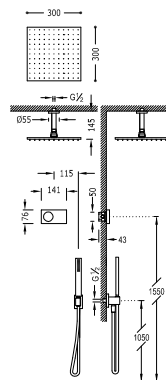

Cr | 092.865.64 |

N

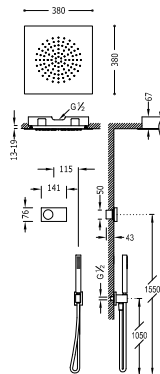

**Kit electrónico de ducha termostático empotrado SHOWER TECHNOLOGY**

- Centralita termostática electrónica incluida (2 vías).
- Rociador ducha INOX a techo 380x380 mm. (299.953.01).
- Soporte con toma pared (207.182.01).
- Ducha móvil anticalcárea (202.639.01).
- Flexo SATIN (91.34.609.15).



Cr 092.865.84

N

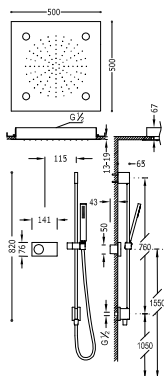

**Kit electrónico de ducha termostático empotrado SHOWER TECHNOLOGY con CROMOTERAPIA**

- Centralita termostática electrónica incluida (2 vías).
- Rociador ducha INOX a techo 500x500 mm. (299.962.01).
- Barra deslizante con toma de agua a pared. Long 760 mm. (034.932.99).
- Ducha móvil anticalcárea (202.639.01).
- Flexo SATIN (91.34.609.15).



Cr 092.865.85



**Kit electrónico de bañera termostático empotrado  
SHOWER TECHNOLOGY**

- Centralita termostática electrónica incluida (2 vías).
- Caño cascada INOX (299.903.04).
- Soporte con toma pared (207.182.01).
- Ducha móvil anticalcárea (202.639.01).
- Flexo SATIN (91.34.609.15).

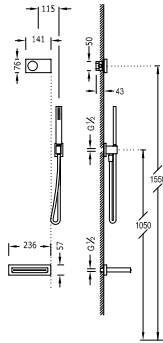

Cr | 092.865.53 |



SHOWER  
TECH.

**Kit electrónico de bañera termostático empotrado  
SHOWER TECHNOLOGY**

- Centralita termostática electrónica incluida (2 vías).
- Caño cascada INOX (299.903.04).
- Ducha móvil anticalcárea (202.639.01).
- Flexo doble engatillado.

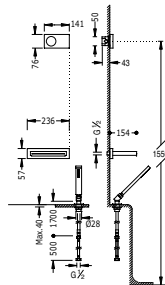

Cr | 092.865.70 |



**Kit electrónico de bañera termostático empotrado  
SHOWER TECHNOLOGY**

- Centralita termostática electrónica incluida (2 vías).
- Desagüe bañera y válvula de llenado cuadrada CASCADA con rebosadero (1.34.534.40).
- Sifón PVC bañera (1.34.634.60).
- Ducha móvil anticalcárea (202.639.01).
- Flexo doble engatillado.

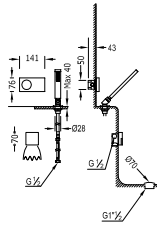

Cr | 092.865.71

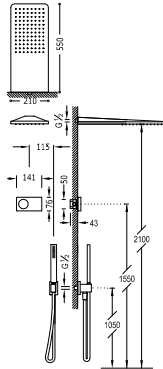

**Kit electrónico de ducha termostático empotrado  
SHOWER TECHNOLOGY**

- Centralita termostática electrónica incluida (2 vías).
- Rociador ducha INOX a pared 210x550 mm. (299.903.07).
- Soporte con toma pared (207.182.01).
- Ducha móvil anticalcárea (034.116.01).
- Flexo SATIN (91.34.609.15).

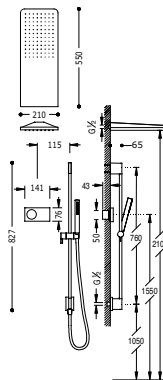

**Kit electrónico de ducha termostático empotrado  
SHOWER TECHNOLOGY**

- Centralita termostática electrónica incluida (2 vías).
- Rociador ducha INOX a pared 210x550 mm. (299.903.07).
- Barra deslizante con toma de agua a pared. Long 760 mm. (034.931.99).
- Ducha móvil anticalcárea (034.116.01).
- Flexo SATIN (91.34.609.15).



Cr | 092.865.54



Cr | 092.865.82

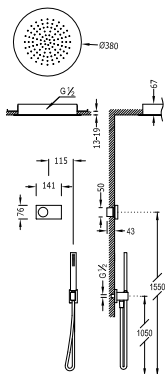

**Kit electrónico de ducha termostático empotrado  
SHOWER TECHNOLOGY**

- Centralita termostática electrónica incluida (2 vías).
- Rociador ducha INOX a techo Ø 380 mm. (1.34.940).
- Soporte con toma pared (207.182.01).
- Ducha móvil anticalcárea (034.116.01).
- Flexo SATIN (91.34.609.15).



Cr 092.865.55

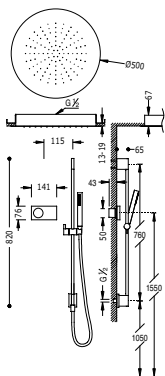

**Kit electrónico de ducha termostático empotrado  
SHOWER TECHNOLOGY**

- Centralita termostática electrónica incluida (2 vías).
- Rociador ducha INOX a techo Ø 500 mm. (1.34.950).
- Barra deslizante con toma de agua a pared. Long 760 mm. (034.931.99).
- Ducha móvil anticalcárea (034.116.01).
- Flexo SATIN (91.34.609.15).



Cr 092.865.83



**Kit electrónico de ducha termostático empotrado  
SHOWER TECHNOLOGY**

- Centralita termostática electrónica incluida (2 vías).
- Rociador ducha INOX a techo Ø 380 mm. (1.34.940).
- Barra deslizante con toma de agua a techo. Long 1.040 mm.
- Ducha móvil anticalcárea (034.116.01).
- Flexo SATIN (91.34.609.15).

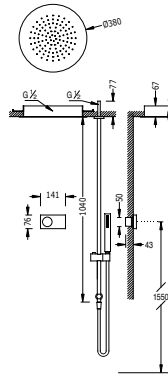

Cr | 092.865.65 |



**Kit electrónico de ducha termostático empotrado  
SHOWER TECHNOLOGY**

- Centralita termostática electrónica incluida (2 vías).
- Rociador ducha INOX a techo Ø 500 mm. (1.34.950).
- Soporte con toma pared (207.182.01).
- Ducha móvil anticalcárea (034.116.01).
- Flexo SATIN (91.34.609.15).

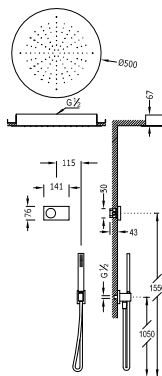

Cr | 092.865.57 |

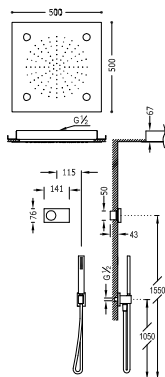

**Kit electrónico de ducha termostático empotrado SHOWER TECHNOLOGY con CROMOTERAPIA**

- Centralita termostática electrónica incluida (2 vías).
- Rociador ducha a techo 500x500 mm. (299.962.01).
- Soporte con toma pared (207.182.01).
- Ducha móvil anticalcárea (034.116.01).
- Flexo SATIN (91.34.609.15).



Cr 092.865.66

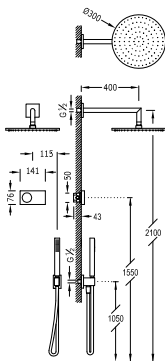

**Kit electrónico de ducha termostático empotrado SHOWER TECHNOLOGY**

- Centralita termostática electrónica incluida (2 vías).
- Ducha fija Ø 300 mm. con rótula. Material Latón (1.34.137.30).
- Soporte con toma pared (207.182.01).
- Ducha móvil anticalcárea (034.116.01).
- Flexo SATIN (91.34.609.15).



Cr 092.865.58





**Kit electrónico de ducha termostático empotrado  
SHOWER TECHNOLOGY**

- Centralita termostática electrónica incluida (2 vías).
- Ducha fija Ø 300 mm. con rótula. Material Latón (1.34.137.30).
- Soporte con toma pared (207.182.01).
- Ducha móvil anticalcárea (034.116.01).
- Flexo SATIN (91.34.609.15).

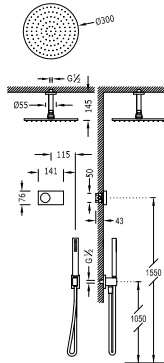

Cr | 092.865.67



**Kit electrónico de ducha termostático empotrado  
SHOWER TECHNOLOGY**

- Centralita termostática electrónica incluida (2 vías).
- Ducha fija Ø 300 mm. con rótula. Material Latón (1.34.137.30).
- Barra de ducha long. 760 mm. (034.637.01).
- Ducha móvil anticalcárea (034.116.01).
- Flexo SATIN (91.34.609.15).

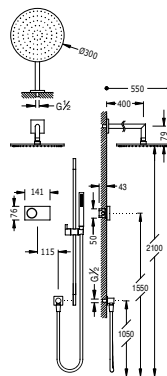

Cr | 092.865.68



**Kit electrónico de bañera termostático empotrado  
SHOWER TECHNOLOGY**

- Centralita termostática electrónica incluida (2 vías).
- Caño cascada INOX (299.903.04).
- Soporte con toma pared (207.182.01).
- Ducha móvil anticalcárea (034.116.01).
- Flexo SATIN (91.34.609).

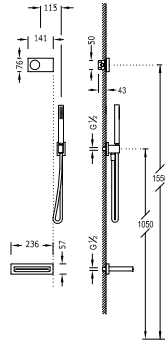

Cr 092.865.56

**Kit electrónico de bañera termostático empotrado  
SHOWER TECHNOLOGY**

- Centralita termostática electrónica incluida (2 vías).
- Desagüe bañera y válvula de llenado redonda CASCADA con rebosadero (1.34.534.30).
- Sifón PVC bañera (1.34.634.60).
- Ducha masaje, 5 posiciones. (299.631.06).
- Flexo doble engatillado.

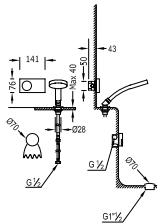

Cr 092.865.73

PARA 3 VÍAS

Ref.:

**N**

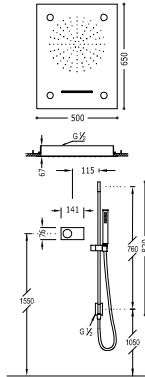

**Kit electrónico de ducha termostático empotrado  
SHOWER TECHNOLOGY con CROMOTERAPIA**

- Centralita termostática electrónica incluida (3 vías).
- Rociador ducha INOX a techo con cascada 500x650 mm. 3 funciones (299.972.01).
- Barra deslizante con toma de agua a pared. Long 760 mm. (034.932-99).
- Ducha móvil anticalcárea (202.639.01).
- Flexo SATIN (91.34.609.15).

IMPORTANTE: Montar un desagüe de >50 l/min.



Cr | 092.863.01

SHOWER  
TECH.

**N**

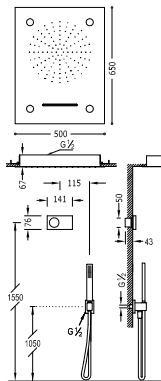

**Kit electrónico de ducha termostático empotrado  
SHOWER TECHNOLOGY con CROMOTERAPIA**

- Centralita termostática electrónica incluida (3 vías).
- Rociador ducha INOX a techo con cascada 500x650 mm. 3 funciones (299.972.01).
- Soporte con toma pared (207.182.01).
- Ducha móvil anticalcárea (202.639.01).
- Flexo SATIN (91.34.609.15).

IMPORTANTE: Montar un desagüe de >50 l/min.



Cr | 092.863.02

N

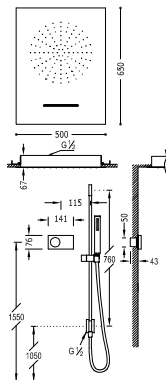

**Kit electrónico de ducha termostático empotrado SHOWER TECHNOLOGY**

- Centralita termostática electrónica incluida (3 vías).
- Rociador ducha INOX a techo con cascada 500x650 mm.
- 2 funciones (299.970.01).
- Barra deslizante con toma de agua a pared. Long 760 mm. (034.932.99).
- Ducha móvil anticalcárea (202.639.01).
- Flexo SATIN (91.34.609.15).

IMPORTANTE: Montar un desague de >50 l/min.



Cr 092.863.03

N

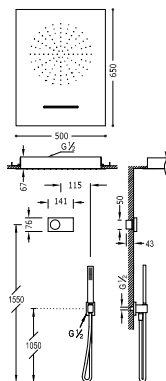

**Kit electrónico de ducha termostático empotrado SHOWER TECHNOLOGY**

- Centralita termostática electrónica incluida (3 vías).
- Rociador ducha INOX a techo con cascada 500x650 mm.
- 2 funciones (299.970.01).
- Soporte con toma pared (207.182.01).
- Ducha móvil anticalcárea (202.639.01).
- Flexo SATIN (91.34.609.15).

IMPORTANTE: Montar un desague de >50 l/min.



Cr 092.863.04

**Kit electrónico de ducha termostático empotrado  
SHOWER TECHNOLOGY**

- Centralita termostática electrónica incluida (3 vías).
- Rociador ducha INOX a techo 500x500 mm. 2 funciones (299.954.01).
- Barra deslizante con toma de agua a pared. Long 760 mm. (034.932.99).
- Ducha móvil anticalcárea (202.639.01).
- Flexo SATIN (91.34.609.15).

IMPORTANTE: Montar un desagüe de >50 l/min.

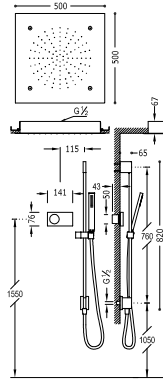

Cr | 092.863.05

**Kit electrónico de ducha termostático empotrado  
SHOWER TECHNOLOGY**

- Centralita termostática electrónica incluida (3 vías).
- Rociador ducha INOX a techo 500x500 mm. 2 funciones (299.954.01).
- Soporte con toma pared (207.182.01).
- Ducha móvil anticalcárea (202.639.01).
- Flexo SATIN (91.34.609.15).

IMPORTANTE: Montar un desagüe de >50 l/min.

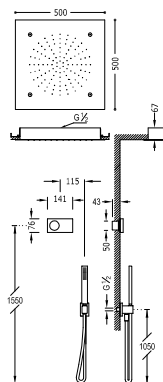

Cr | 092.863.06

N

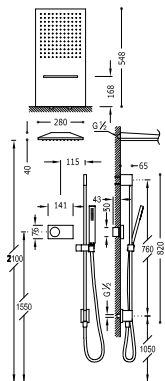

**Kit electrónico de ducha termostático empotrado  
SHOWER TECHNOLOGY**

- Centralita termostática electrónica incluida (3 vías).
- Rociador ducha INOX a pared con cascada 280x550 mm.
- 2 funciones (299.903.01).
- Barra deslizante con toma de agua a pared. Long 760 mm. (034.932.99).
- Ducha móvil anticalcárea (202.639.01).
- Flexo SATIN (91.34.609.15).

IMPORTANTE: Montar un desagüe de >50 l/min.



Cr 092.863.07

N

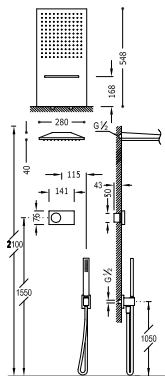

**Kit electrónico de ducha termostático empotrado  
SHOWER TECHNOLOGY**

- Centralita termostática electrónica incluida (3 vías).
- Rociador ducha INOX a pared con cascada 280x550 mm.
- 2 funciones (299.903.01).
- Soporte con toma pared (207.182.01).
- Ducha móvil anticalcárea (202.639.01).
- Flexo SATIN (91.34.609.15).

IMPORTANTE: Montar un desagüe de >50 l/min.



Cr 092.863.08

**N**



**Kit electrónico de ducha termostático empotrado  
SHOWER TECHNOLOGY con CROMOTERAPIA**

- Centralita termostática electrónica incluida (3 vías).
  - Rociador ducha INOX a techo 500x500 mm. 2 funciones (299.962.01).
  - 3 jets antical (299.515.04).
  - Barra deslizante con toma de agua a pared. Long 760 mm. (034.932.99).
  - Ducha móvil anticálarea (202.639.01).
  - Flexo SATIN (91.34.609.15).
- IMPORTANTE:** Montar un desagüe de >50 l/min.

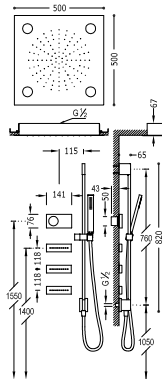

Cr | **092.863.09** | \_\_\_\_\_

SHOWER  
TECH.

**N**



**Kit electrónico de ducha termostático empotrado  
SHOWER TECHNOLOGY con CROMOTERAPIA**

- Centralita termostática electrónica incluida (3 vías).
  - Rociador ducha INOX a techo 500x500 mm. 2 funciones (299.962.01).
  - 3 jets antical (299.515.04).
  - Soporte con toma pared (207.182.01).
  - Ducha móvil anticálarea (202.639.01).
  - Flexo SATIN (91.34.609.15).
- IMPORTANTE:** Montar un desagüe de >50 l/min.

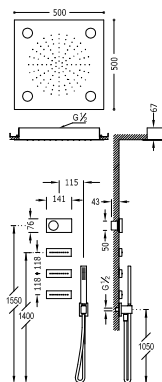

Cr | **092.863.10** | \_\_\_\_\_

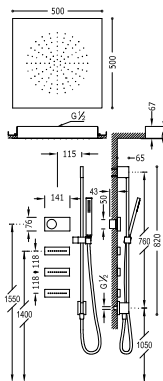

**Kit electrónico de ducha termostático empotrado  
SHOWER TECHNOLOGY**

- Centralita termostática electrónica incluida (3 vías).
- Rociador ducha INOX a techo 500x500 mm. (299.953.02).
- 3 jets antical (299.515.04).
- Barra deslizante con toma de agua a pared. Long 760 mm. (034.932.99).
- Ducha móvil anticalárea (202.639.01).
- Flexo SATIN (91.34.609.15).

IMPORTANTE: Montar un desagüe de >50 l/min.



Cr 092.863.11

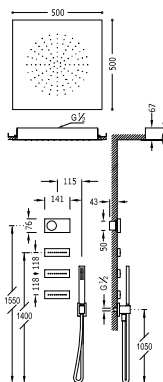

**Kit electrónico de ducha termostático empotrado  
SHOWER TECHNOLOGY**

- Centralita termostática electrónica incluida (3 vías).
- Rociador ducha INOX a techo 500x500 mm. (299.953.02).
- 3 jets antical (299.515.04).
- Soporte con toma pared (207.182.01).
- Ducha móvil anticalárea (202.639.01).
- Flexo SATIN (91.34.609.15).

IMPORTANTE: Montar un desagüe de >50 l/min.



Cr 092.863.12



**N**



**Kit electrónico de ducha termostático empotrado  
SHOWER TECHNOLOGY**

- Centralita termostática electrónica incluida (3 vías).
- Rociador ducha INOX a techo 380x380 mm. (299.953.01).
- 3 jets antical (299.515.04).
- Soporte con toma pared (207.182.01).
- Ducha móvil anticalcárea (202.639.01).
- Flexo SATIN (91.34.609.15).

IMPORTANTE: Montar un desagüe de >50 l/min.

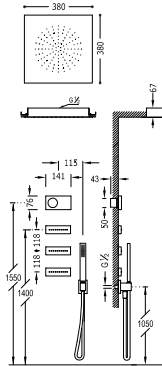

Cr | **092.863.13**

**N**



**Kit electrónico de ducha termostático empotrado  
SHOWER TECHNOLOGY**

- Centralita termostática electrónica incluida (3 vías).
- Rociador ducha INOX a pared 210x550 mm. (299.903.02).
- 3 jets antical (299.515.04).
- Soporte con toma pared (207.182.01).
- Ducha móvil anticalcárea (202.639.01).
- Flexo SATIN (91.34.609.15).

IMPORTANTE: Montar un desagüe de >50 l/min.

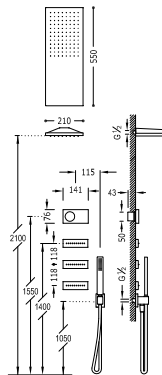

Cr | **092.863.14**

N

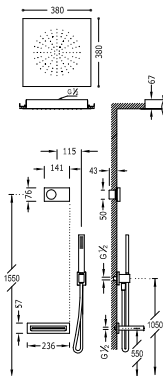

Kit electrónico de bañera termostático empotrado  
SHOWER TECHNOLOGY

- Centralita termostática electrónica incluida (3 vías).
- Rociador ducha INOX a techo 380x380 mm. (299.953.01).
- Caño cascada INOX (299.903.04).
- Soporte con toma pared (207.182.01).
- Ducha móvil anticalcárea (202.639.01).
- Flexo SATIN (91.34.609.15).

IMPORTANTE: Montar un desagüe de >50 l/min.



Cr 092.863.15

N

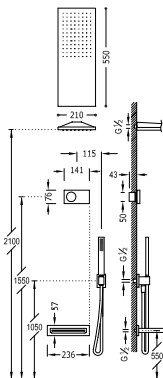

Kit electrónico de bañera termostático empotrado  
SHOWER TECHNOLOGY

- Centralita termostática electrónica incluida (3 vías).
- Rociador ducha INOX a pared 210x350 mm. (299.903.02).
- Caño cascada INOX (299.903.04).
- Soporte con toma pared (207.182.01).
- Ducha móvil anticalcárea (202.639.01).
- Flexo SATIN (91.34.609.15).

IMPORTANTE: Montar un desagüe de >50 l/min.



Cr 092.863.16

**N**



**Kit electrónico de bañera termostático empotrado  
SHOWER TECHNOLOGY**

- Centralita termostática electrónica incluida (3 vías).
- Rociador ducha INOX a techo 380x380 mm. (299.953.01).
- Desagüe para bañera con sistema de llenado tipo CASCADA y rebosadero (1.34.534.40).
- Sifón PVC bañera (1.34.634.60).
- Soporte con toma pared (207.182.01).
- Ducha móvil anticalcárea (202.639.01).
- Flexo SATIN (91.34.609.15).

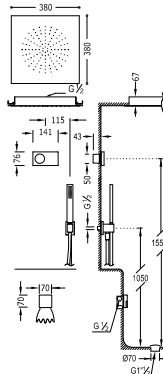

Cr | **092.863.17** |

SHOWER  
TECH.  
[Icon]

**N**



**Kit electrónico de bañera termostático empotrado  
SHOWER TECHNOLOGY**

- Centralita termostática electrónica incluida (3 vías).
- Rociador ducha INOX a pared 210x550 mm. (299.903.02).
- Desagüe para bañera con sistema de llenado tipo CASCADA y rebosadero (1.34.534.40).
- Sifón PVC bañera (1.34.634.60).
- Soporte con toma pared (207.182.01).
- Ducha móvil anticalcárea (202.639.01).
- Flexo SATIN (91.34.609.15).

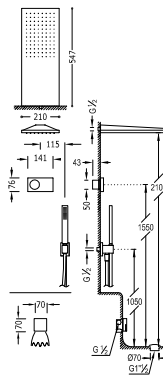

Cr | **092.863.18** |

N

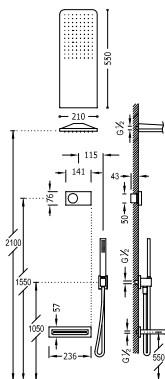

Kit electrónico de bañera termostático empotrado  
SHOWER TECHNOLOGY

- Centralita termostática electrónica incluida (3 vías).
- Rociador ducha INOX a pared 210x550 mm. (299.903.07).
- Caño cascada INOX (299.903.04)
- Soporte con toma pared (207.182.01).
- Ducha móvil anticalcárea (202.639.01).
- Flexo SATIN (91.34.609.15).

IMPORTANTE: Montar un desagüe de >50 l/min.



Cr 092.863.19

N

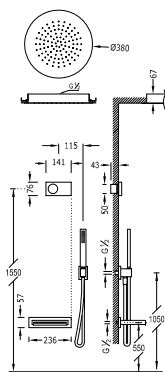

Kit electrónico de bañera termostático empotrado  
SHOWER TECHNOLOGY

- Centralita termostática electrónica incluida (3 vías).
- Rociador ducha INOX a techo Ø 380 mm. (1.34.940).
- Caño cascada INOX (299.903.04)
- Soporte con toma pared (207.182.01).
- Ducha móvil anticalcárea (034.116.01).
- Flexo SATIN (91.34.609.15).

IMPORTANTE: Montar un desagüe de >50 l/min.



Cr 092.863.20

**N**



**Kit electrónico de bañera termostático empotrado  
SHOWER TECHNOLOGY**

- Centralita termostática electrónica incluida (3 vías).
- Rociador ducha INOX a pared 210x550 mm. (299.903.07).
- Desagüe para bañera con sistema de llenado tipo CASCADA y rebosadero (1.34.534.30).
- Sifón PVC bañera (1.34.634.60).
- Soporte con toma pared (207.182.01).
- Ducha móvil anticalcárea (202.639.01).
- Flexo SATIN (91.34.609.15).

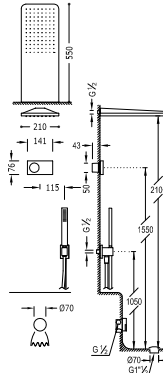

Cr | **092.863.21** |

**N**



**Kit electrónico de bañera termostático empotrado  
SHOWER TECHNOLOGY**

- Centralita termostática electrónica incluida (3 vías).
- Rociador ducha INOX a techo Ø 380 mm. (1.34.940).
- Desagüe para bañera con sistema de llenado tipo CASCADA y rebosadero (1.34.534.30).
- Sifón PVC bañera (1.34.634.60).
- Soporte con toma pared (207.182.01).
- Ducha móvil anticalcárea (034.116.01).
- Flexo SATIN (91.34.609.15).

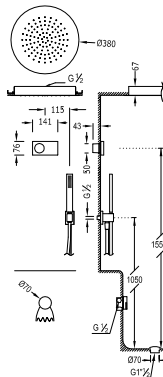

Cr | **092.863.22** |

PARA 4 VÍAS

Ref.:

N

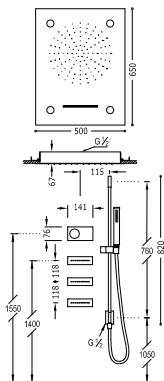

Kit electrónico de ducha termostático empotrado SHOWER TECHNOLOGY con CROMOTERAPIA

- Centralita termostática electrónica incluida (4 vías).
- Rociador ducha INOX a techo con cascada 500x650 mm.
- 3 funciones (299.972.01).
- jets antical (299.515.04).
- Barra deslizante con toma de agua a pared. Long 760 mm. (034.932.99).
- Ducha móvil anticalcárea (202.639.01).
- Flexo SATIN (91.34.609.15).

IMPORTANTE: Montar un desagüe de >50 l/min.



Cr 092.864.01

N

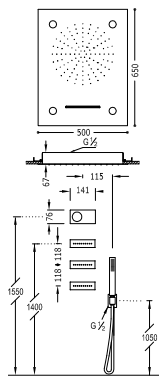

Kit electrónico de ducha termostático empotrado SHOWER TECHNOLOGY con CROMOTERAPIA

- Centralita termostática electrónica incluida (4 vías).
- Rociador ducha INOX a techo con cascada 500x650 mm.
- 3 funciones (299.972.01).
- jets antical (299.515.04).
- Soporte con toma pared (207.182.01).
- Ducha móvil anticalcárea (202.639.01).
- Flexo SATIN (91.34.609.15).

IMPORTANTE: Montar un desagüe de >50 l/min.



Cr 092.864.02



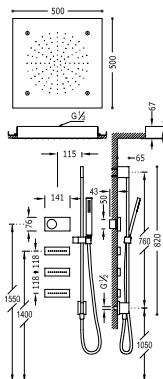

**Kit electrónico de ducha termostático empotrado  
SHOWER TECHNOLOGY**

- Centralita termostática electrónica incluida (4 vías).
- Rociador ducha INOX a techo 500x500 mm. 2 funciones (299.954.01).
- 3 jets antical (299.515.04).
- Barra deslizante con toma de agua a pared. Long 760 mm. (034.932.99).
- Ducha móvil anticalcárea (202.639.01).
- Flexo SATIN (91.34.609.15).

IMPORTANTE: Montar un desagüe de >50 l/min.



Cr 092.864.05

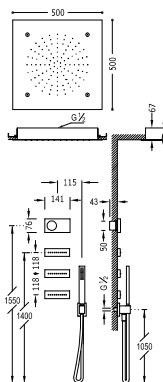

**Kit electrónico de ducha termostático empotrado  
SHOWER TECHNOLOGY**

- Centralita termostática electrónica incluida (4 vías).
- Rociador ducha INOX a techo 500x500 mm. 2 funciones (299.954.01).
- 3 jets antical (299.515.04).
- Soporte con toma pared (207.182.01).
- Ducha móvil anticalcárea (202.639.01).
- Flexo SATIN (91.34.609.15).

IMPORTANTE: Montar un desagüe de >50 l/min.



Cr 092.864.06





**Kit electrónico de ducha termostático empotrado  
SHOWER TECHNOLOGY**

- Centralita termostática electrónica incluida (4 vías).
  - Rociador ducha INOX a pared con cascada 280x550 mm.
  - 2 funciones (299.903.01).
  - 3 jets antical (299.515.04).
  - Barra deslizante con toma de agua a pared. Long 760 mm. (034.932.99).
  - Ducha móvil anticalcárea (202.639.01).
  - Flexo SATIN (91.34.609.15).
- IMPORTANTE: Montar un desagüe de >50 l/min.

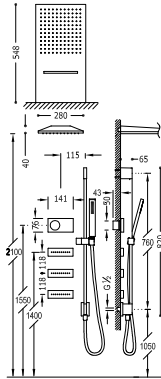

Cr | 092.864.07



**Kit electrónico de ducha termostático empotrado  
SHOWER TECHNOLOGY**

- Centralita termostática electrónica incluida (4 vías).
  - Rociador ducha INOX a pared con cascada 280x550 mm.
  - 2 funciones (299.903.01).
  - 3 jets antical (299.515.04).
  - Soporte con toma pared (207.182.01).
  - Ducha móvil anticalcárea (202.639.01).
  - Flexo SATIN (91.34.609.15).
- IMPORTANTE: Montar un desagüe de >50 l/min.

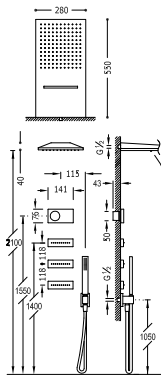

Cr | 092.864.08

## MONOMANDOS CON EL CONFORT DE UNA TERMOSTÁTICA

Utilizar un grifo Mono-term® en tu ducha o bañera tiene muchas ventajas. La misma facilidad de uso que cualquier otro monomando pero con una tecnología avanzada que ofrece el confort similar de una termostática.

Descubre porqué MONO-TERM® será la tecnología de los monomandos del futuro.



### Ventajas frente a otro tipo de monomandos



#### Ahorro

Se consigue la temperatura deseada con mayor rapidez que con otro tipo de grifo monomando.



#### Control

Limita la temperatura a un máximo de 48/49°C, con lo que se evita el riesgo de quemaduras.



#### Confort

La temperatura se mantiene constante ante variaciones de presión o de temperatura ( $\pm 2^\circ\text{C}$ ).

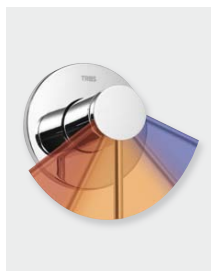

#### Funcionalidad

La maneta regula el caudal y la temperatura igual que cualquier monomando convencional.



### El secreto está en el cartucho

**Patentado:** con la creación del cartucho patentado Mono-term®, estos monomandos son los ÚNICOS con estas características disponible en el mercado.

**Fiabilidad:** los discos del cartucho están contruidos de material cerámico y son totalmente anticalcáreos e insensibles a las deposiciones de cal.

**Acústica:** su nivel acústico es más bajo respecto a otros cartuchos cerámicos.

**Mantenimiento:** sin filtros ni válvulas antirretorno, es apto para aguas duras (cal, arenilla...).



#### Seguridad

En el caso, improbable, de que se interrumpa el suministro de agua fría, el cartucho corta automáticamente el agua caliente.

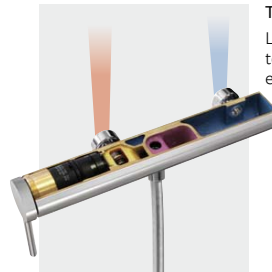

#### Tecnología Touch-cool®

La superficie del grifo está a una temperatura apta para el tacto evitando quemaduras.



#### Precisión

Los mandos incorporan la marca 38°C, demostrando la precisión en la elección de la temperatura.



#### Diseño

Modelos empotrados y de superficie con una maneta ergonómica de diseño singular.

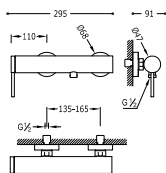

**MONO-TERM® ducha**

Ducha de mano anticalcárea (034.116.01) con soporte orientable y flexo SATIN (91.34.609.15).



299.195.05

Cr **062.168.01**

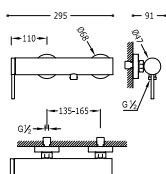

**MONO-TERM® ducha**

Ducha de mano masaje Ø 100 mm. (5 funciones) (1.34.748) con soporte orientable. Flexo SATIN (91.34.609.15).



299.195.05

Cr **201.167.01**

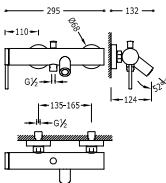

**MONO-TERM® bañera-ducha**

Ducha de mano anticalcárea (034.116.01) con soporte orientable y flexo SATIN (91.34.609).



299.195.05

Cr **062.178.01**

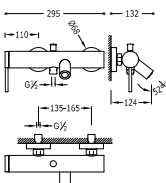

**MONO-TERM® bañera-ducha**

Ducha de mano masaje Ø 100 mm. (5 funciones) (1.34.748) con soporte orientable. Flexo SATIN (91.34.609).



299.195.05

Cr **201.170.01**

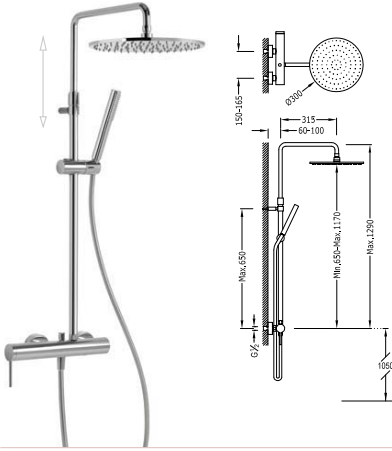

**Conjunto ducha MONO-TERM®**

- Ducha fija Ø 300 mm. con rótula. Material Latón (1.34.137.30).
- Ducha móvil anticalcárea (034.116.01).
- Flexo SATIN (91.34.609.15).
- Barra telescópica.



299.195.05

Cr | 062.378.01 |

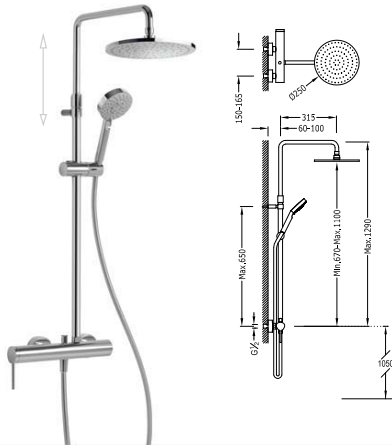

**Conjunto ducha MONO-TERM®**

- Ducha fija Ø 250 mm. con rótula. (1.34.137.26).
- Ducha móvil masaje Ø 100 mm. (5 funciones) (1.34.748).
- Flexo SATIN (91.34.609.15).
- Barra telescópica.



299.195.05

Cr | 201.195.01 |



CONJUNTOS EMPOTRADOS MONO-TERM®

Ref.:

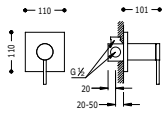

**MONO-TERM® de empotrar (1 vía)**  
con cierre y regulación de caudal.  
- Cuerpo empotrado incluido



299.195.05 BELGARA  
Cr 201.177.01

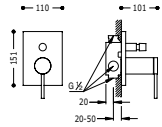

**MONO-TERM® de empotrar (2 vías)**  
con cierre y regulación de caudal.  
- Cuerpo empotrado incluido



299.195.05 BELGARA  
Cr 201.180.01

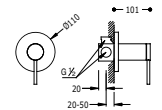

**MONO-TERM® de empotrar (1 vía)**  
con cierre y regulación de caudal.  
- Cuerpo empotrado incluido



299.195.05 BELGARA  
Cr 201.177.02

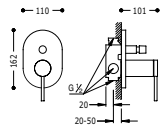

**MONO-TERM® de empotrar (2 vías)**  
con cierre y regulación de caudal.  
- Cuerpo empotrado incluido



299.195.05 BELGARA  
Cr 201.180.02

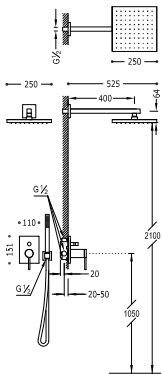

**Kit MONO-TERM® de empotrar ducha**  
con cierre y regulación de caudal.  
- Cuerpo empotrado incluido  
- Ducha fija 250x250 mm. con rótula. (1.34.138.26).  
- Soporte con toma pared (006.182.01).  
- Ducha móvil anticalcárea (006.639.01).  
- Flexo SATIN (91.34.609.15).



299.195.05 BELGARA  
Cr 201.180.06

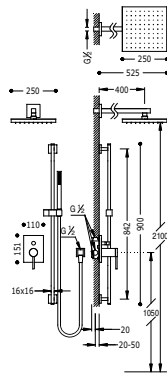

**Kit MONO-TERM® de empotrar ducha**

- con cierre y regulación de caudal.
- Cuerpo empotrado incluido
- Ducha fija 250x250 mm. con rótula. (1.34.138.26).
- Barra deslizante long. 842 mm. (1.07.935).
- Codo toma pared (006.183.01).
- Ducha móvil anticalcárea (006.639.01).
- Flexo SATIN (91.34.609).



299.195.05  
Cr | **201.180.07** |

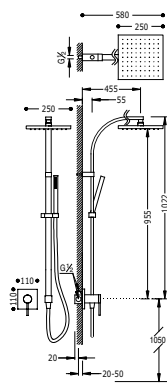

**Kit MONO-TERM® de empotrar ducha**

- con cierre y regulación de caudal.
- Cuerpo empotrado incluido
- Ducha fija 250x250 mm. con rótula. (1.34.138.26).
- Ducha móvil anticalcárea (006.639.01).
- Flexo SATIN (91.34.609.15).
- Con toma pared.



299.195.05  
Cr | **201.177.04** |

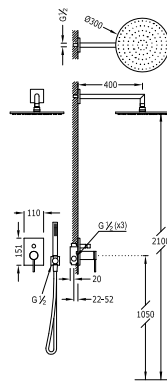

**Kit MONO-TERM® de empotrar ducha**

- con cierre y regulación de caudal.
- Cuerpo empotrado incluido
- Ducha fija Ø 300 mm. con rótula. Material Latón. (1.34.137.30).
- Soporte con toma pared (061.182.01).
- Ducha móvil anticalcárea (034.116.01).
- Flexo SATIN (91.34.609.15).



299.195.05  
Cr | **062.180.03** |

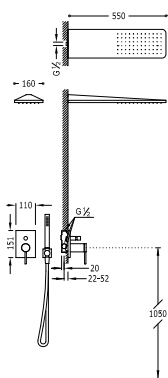

**Kit MONO-TERM® de empotrar ducha**

- con cierre y regulación de caudal.
- Cuerpo empotrado incluido
- Ducha INOX 160x550 mm. (299.903.06).
- Soporte con toma pared. (061.182.01).
- Ducha móvil anticalcárea. (034.116.01).
- Flexo SATIN (91.34.609.15).



299.195.05

Cr **062.180.10**

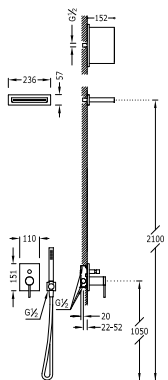

**Kit MONO-TERM® de empotrar ducha**

- con cierre y regulación de caudal.
- Cuerpo empotrado incluido
- Ducha INOX con cascada 152x200 mm. (299.903.04).
- Soporte con toma pared (061.182.01).
- Ducha móvil anticalcárea (034.116.01).
- Flexo SATIN (91.34.609.15).



299.195.05

Cr **062.180.06**

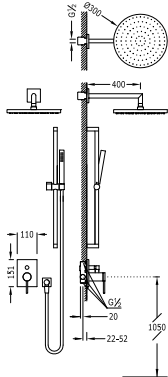

**Kit MONO-TERM® de empotrar ducha**

- con cierre y regulación de caudal.
- Cuerpo empotrado incluido
- Ducha fija Ø 300 mm. con rótula. Material Latón. (1.34.137.30).
- Codo toma pared (061.183.01).
- Barra deslizante long. 673 mm. (034.637.06).
- Ducha móvil anticalcárea (034.116.01).
- Flexo SATIN (91.34.609.15).



299.195.05

Cr **062.180.07**



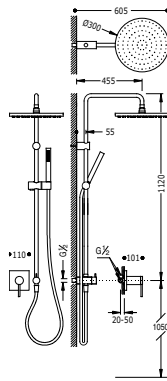

**Kit MONO-TERM® de empotrar ducha**

con cierre y regulación de caudal.

- Cuerpo empotrado incluido
- Ducha fija Ø 300 mm. con rótula. Material Latón. (1.34.137.30).
- Ducha móvil anticalcárea (034.116.01).
- Flexo SATIN (91.34.609.15).
- Con toma pared.



299.195.05

Cr | **062.180.08** |

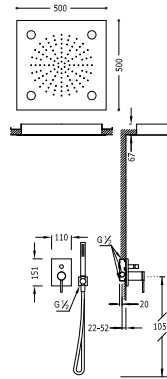

**Kit MONO-TERM® de empotrar ducha CROMOTERAPIA**

con cierre y regulación de caudal.

- Cuerpo empotrado incluido
- Rociador ducha a techo 500x500 mm. (299.962.01).
- Soporte con toma pared (061.182.01).
- Ducha móvil anticalcárea (034.116.01).
- Flexo SATIN (91.34.609.15).



299.195.05

Cr | **062.180.11** |

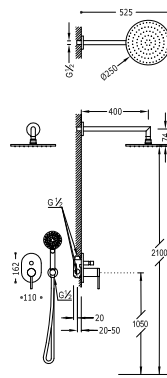

**Kit MONO-TERM® de empotrar ducha**

con cierre y regulación de caudal.

- Cuerpo empotrado incluido
- Ducha fija Ø 250 mm. con rótula. (1.34.137.26).
- Soporte con toma pared (205.182.01).
- Ducha móvil masaje Ø 100 mm. (5 funciones) (1.34.748).
- Flexo SATIN (91.34.609.15).



299.195.05

Cr | **201.180.03** |



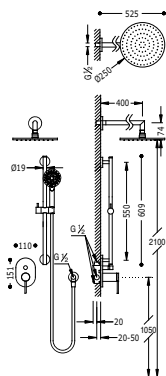

**Kit MONO-TERM® de empotrar ducha**

- con cierre y regulación de caudal.
- Cuerpo empotrado incluido
- Ducha fija Ø 250 mm. con rótula. (1.34.137.26).
- Barra deslizante long. 550 mm. (1.34.618).
- Codo toma pared (205.183.01).
- Ducha móvil masajé Ø 100 mm. (5 funciones) (1.34.748).
- Flexo SATIN (91.34.609.15).



299.195.05  
 REBAJADA  
 Cr 201.180.04

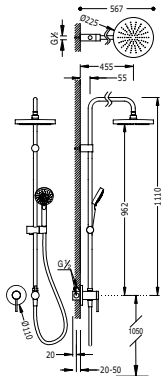

**Kit MONO-TERM® de empotrar ducha**

- con cierre y regulación de caudal.
- Cuerpo empotrado incluido
- Ducha fija Ø 225 mm. con rótula. (299.632.01).
- Ducha móvil masajé Ø 100 mm. (5 funciones) (1.34.748).
- Flexo SATIN (91.34.609.15).
- Con toma pared.



299.195.05  
 REBAJADA  
 Cr 201.177.03

**MONO-TERM® de empotrar baño-ducha**

- con cierre y regulación de caudal. (2 vías).
- Desagüe bañera y válvula de llenado redonda CASCADA con rebosadero (1.34.534.30).
- Sifón PVC bañera (1.34.634.60).
- Ducha móvil masajé Ø 100 mm. (5 funciones) (299.631.06).
- Flexo doble engatillado.

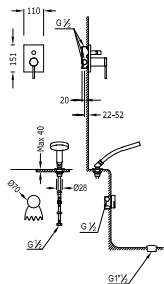

299.195.05  
 REBAJADA  
 Cr 062.180.12

**MONO-TERM® de empotrar baño-ducha**

con cierre y regulación de caudal. (2 vías).

- Desagüe bañera y válvula de llenado redonda CASCADA con rebosadero (1.34.534.30).
- Sifón PVC bañera (1.34.634.60).
- Soporte con toma pared (061.182.01).
- Ducha móvil masaje Ø 100 mm. (5 funciones) (299.631.06).
- Flexo SATIN (91.34.609).

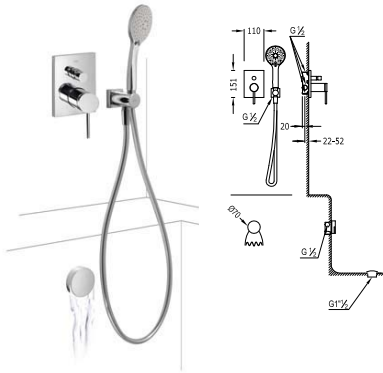

299.195.05



Cr | 062.180.13 |



# MONOMANDO DE 3 VÍAS

## Más funciones con la misma facilidad de uso



-  Rociador de techo / pared con efecto lluvia.
-  Ducha de mano.
-  Segunda función del rociador / jets / caño bañera.

Diseño minimalista y de estética moderna. Fácil de limpiar.

Un solo mando abre/cierra el paso del agua, ajusta la temperatura y regula el caudal.

Selector de funciones para escoger cualquiera de las tres posibles salidas del agua.

Soporte y ducha de mano de latón, con flexo SATIN (higiénico y fácil de limpiar)

El control y el soporte de ducha suministrados en los kits están integrados en un solo cuerpo empotrado no divisible.

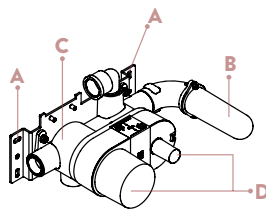

- A** Perfil de instalación a muro o pladur con 3 ejes de nivelación.
- B** Soporte con toma de ducha integrado.
- C** Amortiguadores anti-vibración.
- D** Protectores estancos. La pared queda protegida de humedad.



Ejemplo de instalación del monomando de 3 vías.



Ref:

**N**

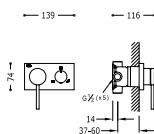

**Monomando empotrar 3V**

- Cuerpo empotrado incluido (3 vías).  
\* NOTA: Para completar este artículo se debe añadir y escoger entre un rociador/ducha de mano/jets/caño bañera.



299.198.02

Cr | 210.273.99

PARA 3 VÍAS

**N**

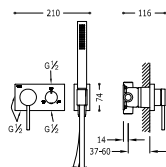

**Monomando empotrar 3V**

- Cuerpo empotrado incluido (3 vías).  
- Ducha móvil anticalcárea (034.116.01).  
- Flexo SATIN (91.34.609.15).  
\* NOTA: Para completar este artículo se debe añadir y escoger entre un rociador/ducha de mano/jets/caño bañera.



299.198.02

Cr | 210.273.91

**N**

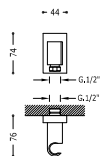

**Soporte para ducha**  
con toma de agua a pared y válvula antirretorno.

Cr | 207.182.01

N



**Monomando empotrar 3V**

- Cuerpo empotrado incluido (3 vías).
- Rociador ducha INOX a pared con cascada 280x550 mm.
- 2 funciones (299.903,01).
- Ducha móvil anticalcárea (034.116.01).
- Flexo SATIN (91.34.609.15).

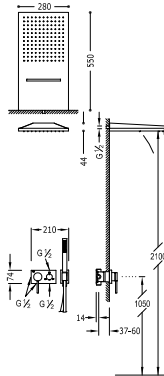

299.198.02

Cr | **210.273.01** |



N



**Monomando empotrar 3V**

- Cuerpo empotrado incluido (3 vías).
- Rociador ducha INOX a techo 500x500 mm. 2 funciones (299.954.01).
- Ducha móvil anticalcárea (034.116.01).
- Flexo SATIN (91.34.609.15).

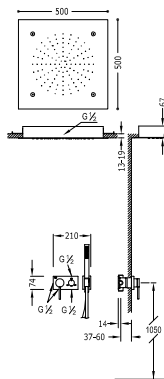

299.198.02

Cr | **210.273.02** |



N



**Monomando empotrar 3V**

- Cuerpo empotrado incluido (3 vías).
- Rociador ducha INOX a techo con cascada 500x650 mm.
- 2 funciones (299.970.01).
- Ducha móvil anticalcárea (034.116.01).
- Flexo SATIN (91.34.609.15).

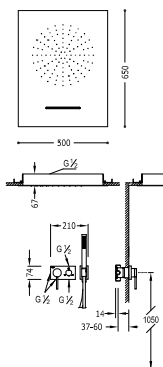

299.198.02

Cr 210.273.03

N



**Monomando empotrar 3V**

- Cuerpo empotrado incluido (3 vías).
- Ducha fija Ø 300 mm. con rótula. Material Latón (1.34.137.30).
- 3 jets anticalcárea (299.515.06).
- Ducha móvil anticalcárea (034.116.01).
- Flexo SATIN (91.34.609.15).

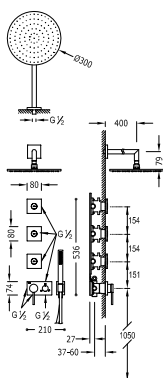

299.198.02

Cr 210.273.04



N



**Monomando empotrar 3V**

- Cuerpo empotrado incluido (3 vías).
- Rociador ducha INOX a pared 160x550 mm. (299.903.03).
- 3 jets antical (299.515.06).
- Ducha móvil anticalcárea (034.116.01).
- Flexo SATIN (91.34.609.15).

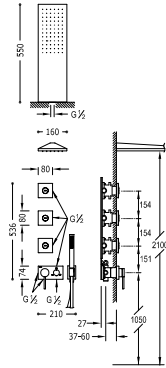

299.198.02

Cr | 210.273.05



N



**Monomando empotrar 3V con CROMOTERAPIA**

- Cuerpo empotrado incluido (3 vías).
- Rociador ducha INOX a techo 500x500 mm. 2 funciones (299.952.01).
- 3 jets antical (299.515.06).
- Ducha móvil anticalcárea (034.116.01).
- Flexo SATIN (91.34.609.15).

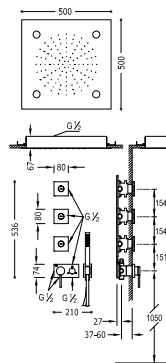

299.198.02

Cr | 210.273.08



N

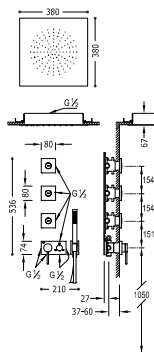

**Monomando empotrar 3V**

- Cuerpo empotrado incluido (3 vías).
- Rociador ducha INOX a techo 380x380 mm. (299.953.01).
- 3 jets antical (299.515.06).
- Ducha móvil anticalcárea (034.116.01).
- Flexo SATIN (91.34.609.15).



299.198.02

Cr 210.273.09

N

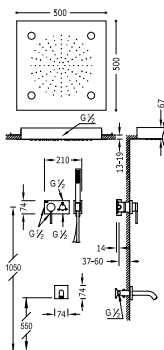

**Monomando empotrar 3V con CROMOTERAPIA**

- Cuerpo empotrado incluido (3 vías).
- Rociador ducha INOX a techo 500x500 mm. 2 funciones (299.962.01).
- Caño bañera.
- Ducha móvil anticalcárea (034.116.01).
- Flexo SATIN (91.34.609.15).



299.198.02

Cr 210.273.06

**N**



**Monomando empotrar 3V con CROMOTERAPIA**

- Cuerpo empotrado incluido (3 vías).
- Rociador ducha INOX a techo 500x500 mm. 2 funciones (299.962.01).
- Desagüe para bañera con sistema de llenado tipo CASCADA y rebosadero (1.34.534.30).
- Sifón PVC bañera (1.34.634.60).
- Ducha móvil anticalcárea (034.116.01).
- Flexo SATIN (91.34.609.15).

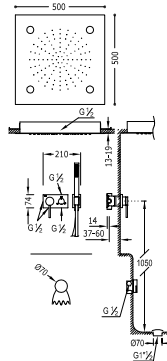

299.198.02



Cr | **210.273.07** |

**N**



**Monomando empotrar 3V**

- Cuerpo empotrado incluido (3 vías).
- Rociador ducha INOX a techo Ø 380 mm. (1.34.940).
- Desagüe para bañera con sistema de llenado tipo CASCADA y rebosadero (1.34.534.30).
- Sifón PVC bañera (1.34.634.60).
- Ducha móvil anticalcárea (034.116.01).
- Flexo SATIN (91.34.609.15).

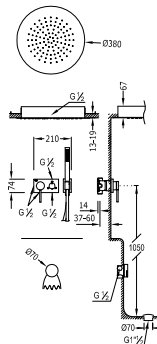

299.198.02



Cr | **210.273.10** |

N



**Monomando empotrar 3V**

- Cuerpo empotrado incluido (3 vías).
- Rociador ducha INOX a techo Ø 380 mm. (1.34.940).
- Caño bañera.
- Ducha móvil anticalcárea (034.116.01).
- Flexo SATIN (91.34.609.15).

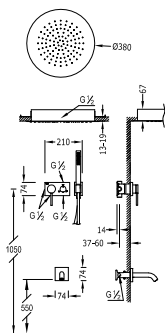

299.198.02

Cr 210.273.11



N



**Monomando empotrar 3V**

- Cuerpo empotrado incluido (3 vías).
- Rociador ducha INOX a pared 160x550 mm. (299.903.03).
- Desagüe para bañera con sistema de llenado tipo CASCADA y rebosadero (1.34.534.30).
- Sifón PVC bañera (1.34.634.60).
- Ducha móvil anticalcárea (034.116.01).
- Flexo SATIN (91.34.609.15).

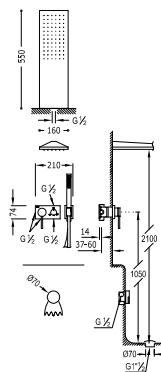

299.198.02

Cr 210.273.12



N



**Monomando empotrar 3V**

- Cuerpo empotrado incluido (3 vías).
- Ducha fija Ø 300 mm. con rótula. Material Latón (1.34.137.30).
- Caño bañera.
- Ducha móvil anticalcárea (034.116.01).
- Flexo SATIN (91.34.609.15).

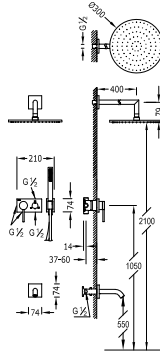

299.198.02

Cr | **210.273.13** |

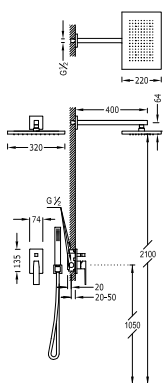

**Kit de ducha monomando empotrado SLIM**

- con cierre y regulación de caudal.
- Cuerpo empotrado incluido
- Ducha fija 320x220 mm. con rótula. Material Latón (299.632.02).
- Soporte con toma pared (066.182.01).
- Ducha móvil anticalcárea (202.639.01).
- Flexo SATIN (91.34.609.15).



91.30.190

Cr 202.180.06

N

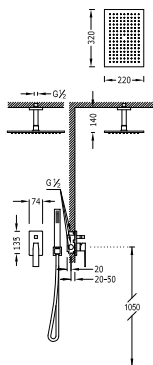

**Kit de ducha monomando empotrado**

- con cierre y regulación de caudal.
- Cuerpo empotrado incluido
- Ducha fija 320x220 mm. con rótula. Material Latón (299.632.02).
- Soporte con toma pared (006.182.01).
- Ducha móvil anticalcárea (202.639.01).
- Flexo SATIN (91.34.609.15).



91.30.190

Cr 202.180.80

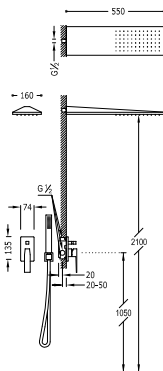

**Kit de ducha monomando empotrado**

- con cierre y regulación de caudal.
- Cuerpo empotrado incluido
- Rociador ducha INOX a pared 160x550 mm.
- Soporte con toma pared.
- Ducha móvil anticalcárea.
- Flexo SATIN (91.34.609.15).



91.30.190

Cr 202.180.03

Ac 202.180.03.AC

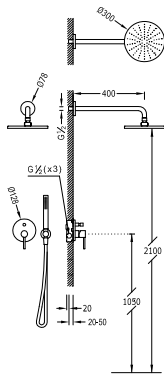

**Kit de ducha monomando empotrado STUDY**

con cierre y regulación de caudal.

- Cuerpo empotrado incluido
- Ducha fija Ø 300 mm. con rótula. Material Latón. (1.34.137.30).
- Soporte con toma pared (205.182.01).
- Ducha móvil anticalcárea (034.116.01).
- Flexo SATIN (91.34.609.15).



91.30.190

Cr | 262.980.91



**Kit de ducha monomando empotrado**

con cierre y regulación de caudal.

- Cuerpo empotrado incluido
- Ducha fija Ø 300 mm. con rótula. Material Latón. (1.34.137.30).
- Soporte con toma pared (205.182.01).
- Ducha móvil anticalcárea (034.116.01).
- Flexo SATIN (91.34.609.15).

**N**

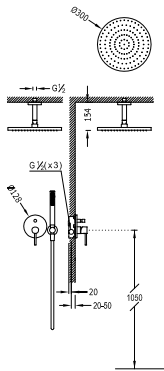

91.30.190

Cr | 262.180.80









## PROGRAMA DE DUCHAS



Rociadores

**220**



Barras deslizantes

**229**



Duchas de mano

**230**



Jets

**232**

[www.tresgriferia.com](http://www.tresgriferia.com)



**RECAMBIOS**  
DE LOS ARTÍCULOS EN  
[www.tresgriferia.com](http://www.tresgriferia.com)

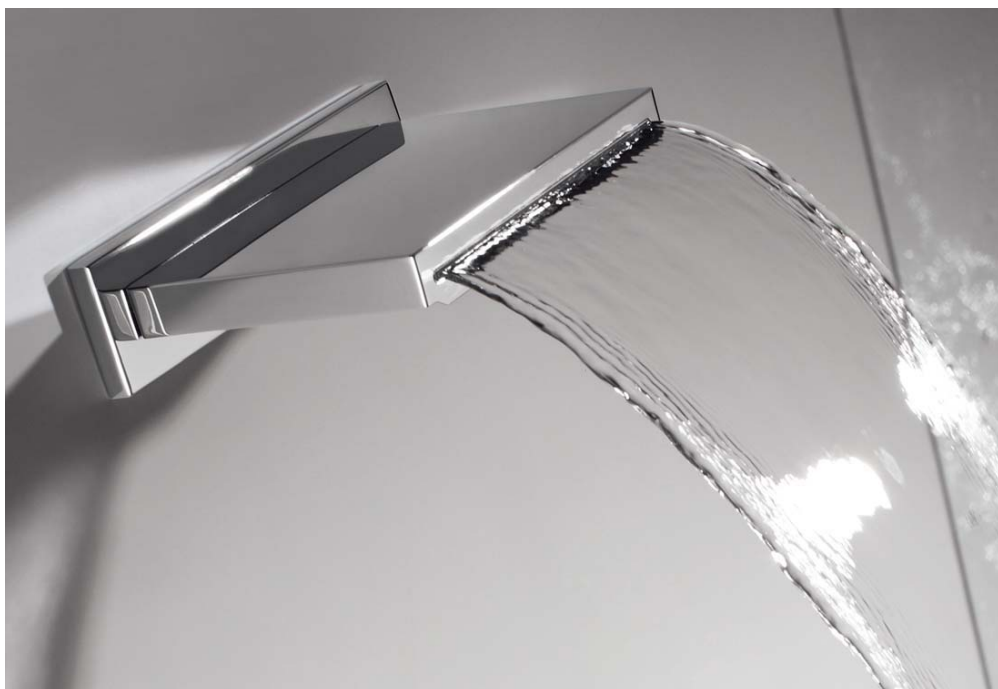



# UNA EXPERIENCIA NUEVA EN LA DUCHA

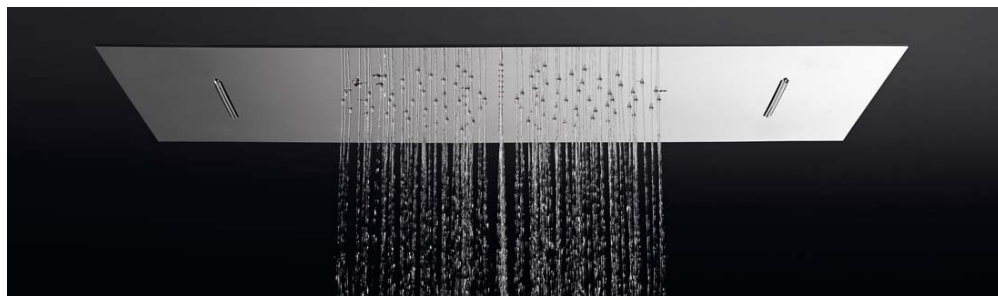

## Rociadores de gran formato



Rociadores de techo empotrados, extraplanos.



Fabricados en acero inoxidable.

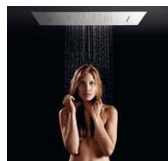

Efecto envolvente gracias a la distribución de chorros y los limitadores de caudal.



Boquillas de silicona antical que facilitan su limpieza.



Salidas de agua combinadas: Lluvia, cascada, micro drop.

## Tipos de chorro

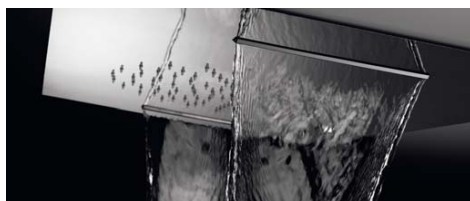

Cascada o doble cascada.



Efecto lluvia.



Micro drop.  
Dispensa el agua en forma de gotas minúsculas.



## Cromoterapia



9 colores con ciclos de 2 minutos.



Los rociadores TRES Cromoterapia se basan en la combinación del agua con los colores, y ofrecen el mejor método de armonización basado en las propiedades revitalizantes de la luz, unidas al bienestar y el confort que nos entrega una ducha.

## Activación de las luces LED

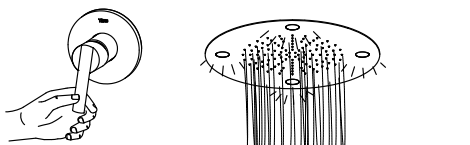

Las luces led se pueden activar de forma automática. Cuando se abre el grifo empieza el ciclo de luz.

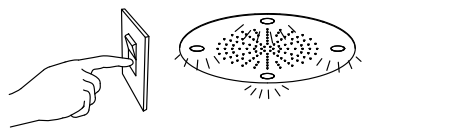

También se puede activar de forma manual si se instala el rociador para este fin; el ciclo de luz se activa a través de un interruptor externo (no suministrado) independientemente de si se abre el grifo o no.

ROCIADORES

Ref.:

Rociador ducha INOX a techo anticalcárea

Anticalcárea de 2 funciones (luvia/cascada), 500x800 mm. Alimentación mediante 3 vías de agua independientes.

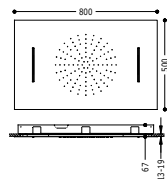
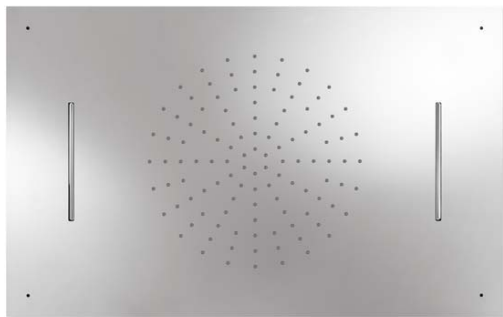

Cr 299.966.01



Rociador ducha INOX a techo CROMOTERAPIA

Anticalcárea de 3 funciones (luvia/cascada/cromoterapia), 500x800 mm. Alimentación mediante 3 vías de agua independientes. La luz, previa conexión a corriente, se activa manualmente mediante interruptor.

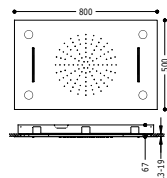
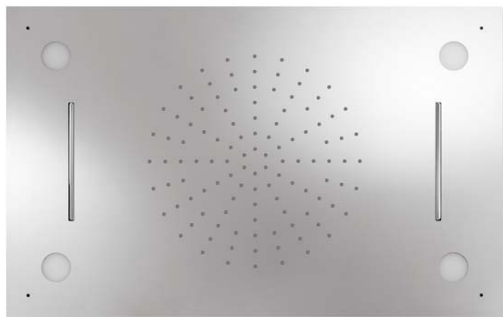

Cr 299.965.01

**N** Rociador ducha INOX a techo anticálcarea

Anticálcarea de 2 funciones (lluvia/cascada). 500x650 mm. Alimentación mediante 2 vías de agua independientes.

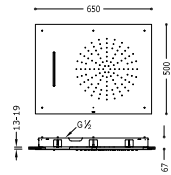
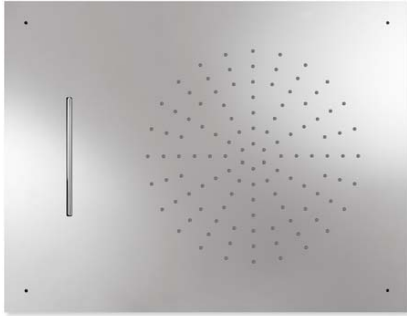

Cr | 299.970.01 |



**N** Rociador ducha INOX a techo CROMOTERAPIA

Anticálcarea de 3 funciones (lluvia/cascada/cromoterapia). 500x650 mm. Alimentación mediante 2 vías de agua independientes. La luz, previa conexión a corriente, se activa manualmente mediante interruptor.

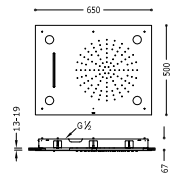
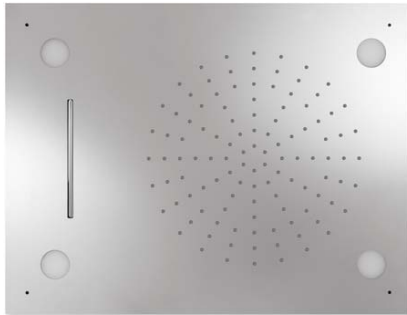

Cr | 299.972.01 |

CROMOTERAPIA



**N** Rociador ducha INOX a techo anticalcárea

Anticalcárea de 3 funciones (lluvia/cascada/micro drop). 500x650 mm. Alimentación mediante 3 vías de agua independientes.

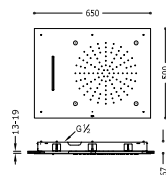
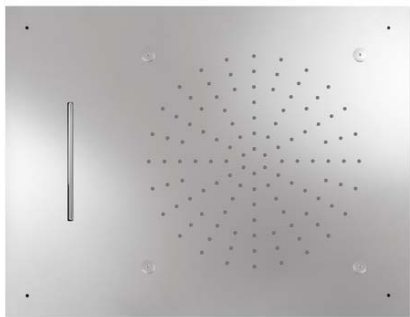

Cr 299.971.01



Rociador ducha INOX a techo CROMOTERAPIA

Anticalcárea. 500x500 mm. La luz, previa conexión a corriente, se enciende con el paso del agua, sin necesidad del interruptor.

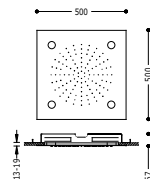
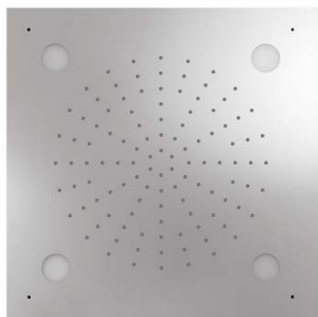

Cr 299.962.01





**Rociador ducha INOX a techo anticalcárea**

Anticalcárea de 2 funciones (Lluvia/Micro drop). 500x500 mm. Alimentación mediante 2 vías de agua independientes.

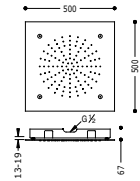
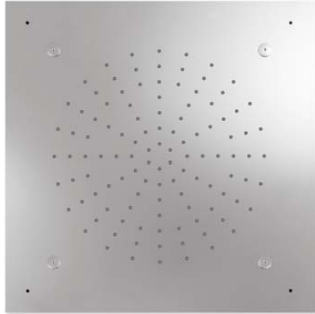

500  
500

Cr | 299.954.01 |



**Rociador ducha INOX a techo anticalcárea**

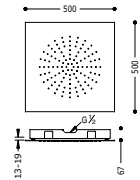
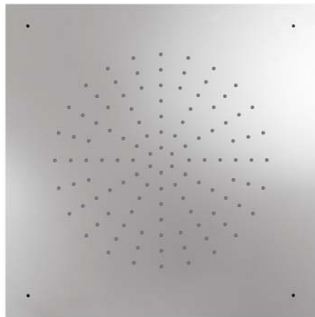

500  
500

Cr | 299.953.02 |

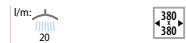
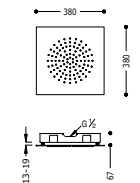

380  
380

Cr | 299.953.01 |



Rociador ducha INOX a techo LOFT  
Anticalcárea con cascada

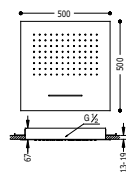
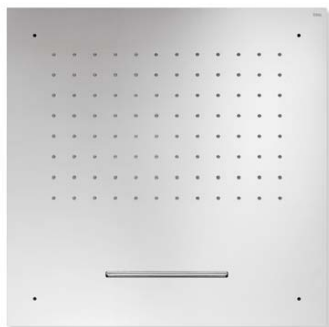

Cr 299.955.01



Rociador ducha INOX a techo anticalcárea

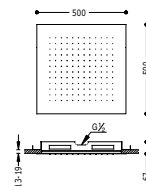
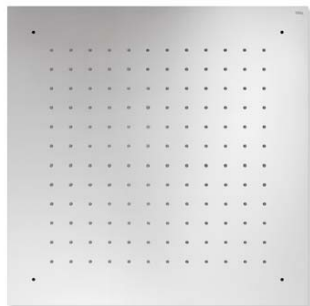

Cr 1.34.951

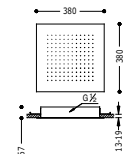

Cr 1.34.944



Rociador ducha INOX a techo anticalcárea  
420x420 mm.

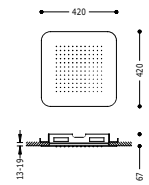

Cr | 299.516.07



Rociador ducha INOX a pared  
con cascada. 152x200 mm.

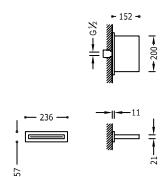

Cr | 299.903.04



**Rociador ducha INOX a techo anticalcárea**

Anticalcárea de 2 funciones (lluvia/Micro drop), Ø 600 mm. Alimentación mediante 2 vías de agua independientes.

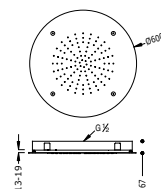

**Rociador ducha INOX a techo CROMOTERAPIA**

Anticalcárea de 2 funciones (lluvia/cromoterapia), Ø 600 mm. Alimentación mediante 1 vía de agua independiente. La luz, previa conexión a corriente, se activa con el paso del agua, sin necesidad del interruptor.

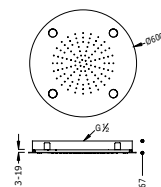
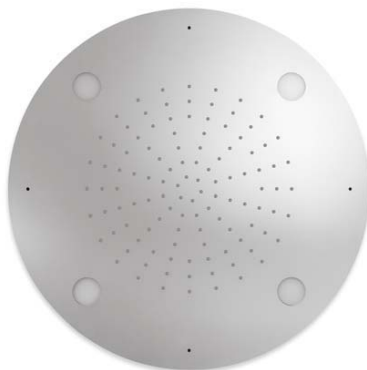

**Rociador ducha INOX a techo CROMOTERAPIA**

Anticalcárea de 3 funciones (Lluvia/Micro drop/cromoterapia). Ø 600 mm. Alimentación mediante 2 vías de agua independientes. La luz, previa conexión a corriente, se activa manualmente mediante interruptor.

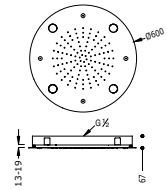

Cr | 299.958.01 |

CROMOTERAPIA



**Rociador ducha INOX a techo anticalcárea**

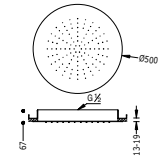
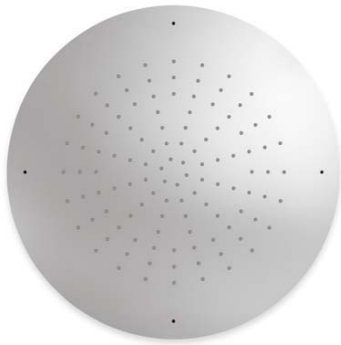

Cr | 1.34.950 |

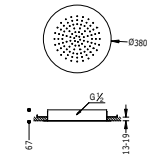

Cr | 1.34.940 |



Ref.: |

**Rociador ducha INOX a pared**

Anticalcárea con cascada. 280x550 mm.

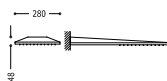
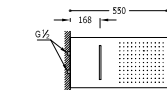

Cr **299.903.01** |

**Rociador ducha INOX a pared**

Anticalcárea con cascada. 280x550 mm.

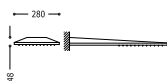
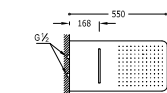

Cr **299.903.08** |

**Rociador ducha INOX a pared TRES-CONFORT**

Anticalcárea con cascada

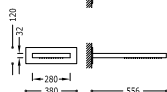
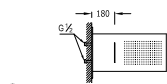

Cr **1.34.903** |

**BARRAS DESLIZANTES**

Ref.:

Barra deslizante con toma de agua a pared  
Ø 14 mm. Long. 760 mm.

Barra deslizante con toma de agua a pared  
Ø 14 mm. Long. 760 mm.

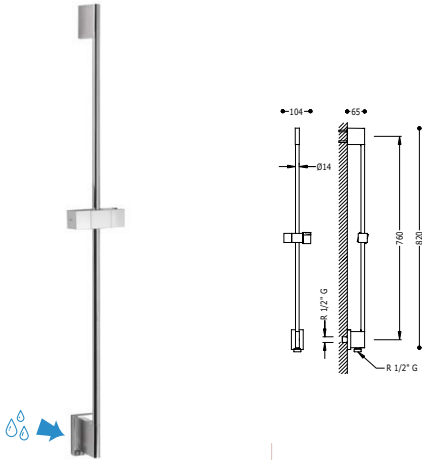

Cr **034.932.99**

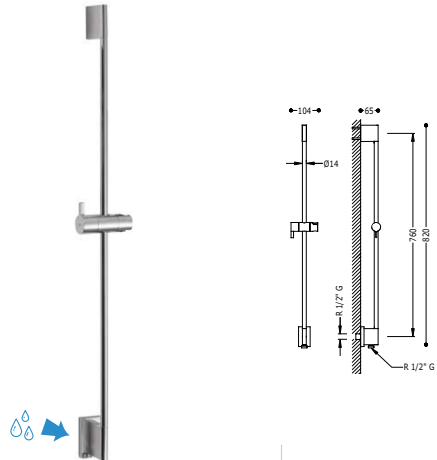

Cr **034.931.99**

Barra deslizante con toma de agua a pared  
Ø 14 mm. Long. 760 mm. Ducha móvil anticalcárea. (202.639.01). Flexo SATIN

Barra deslizante con toma de agua a pared  
Ø 14 mm. Long. 760 mm. Ducha móvil anticalcárea. (034.116.01). Flexo SATIN

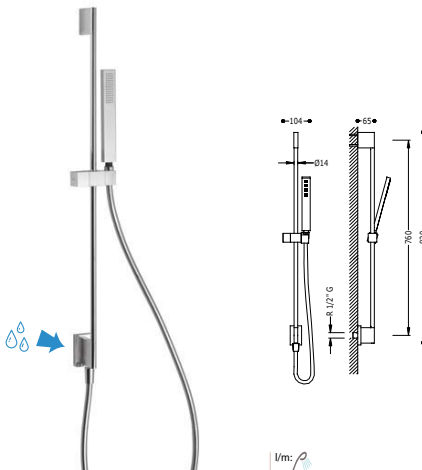

l/m: 9.5  
Cr **034.932.01**

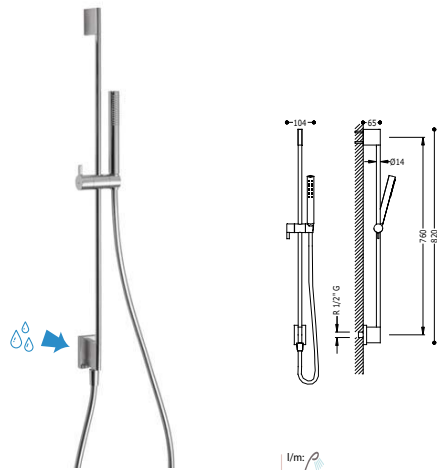

l/m: 9.5  
Cr **034.931.01**

DUCHAS

Ref.:

Ducha anticalcárea SLIM  
Latón

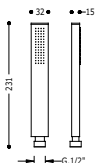

l/m:  $\rho$   
9,5

Cr	202.639.01
Ac	202.639.01.AC

Ducha anticalcárea CUADRO  
Latón

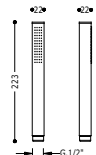

l/m:  $\rho$   
9,5

Cr	006.639.01
Ac	006.639.01.AC
	006.639.01.NG
	006.639.01.BL

Ducha anticalcárea LOFT  
Latón

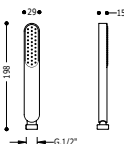

l/m:  $\rho$   
13

Cr	034.639.01
Ac	034.639.01.AC
	034.639.01.AM
	034.639.01.NA
	034.639.01.RO
	034.639.01.VI
	034.639.01.FU
	034.639.01.VE
	034.639.01.NE
	034.639.01.BL

Ducha anticalcárea TUB  
Latón

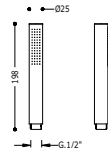

l/m:  $\rho$   
9,5

Cr	034.116.01
Ac	034.116.01.AC
	034.116.01.AM
	034.116.01.NA
	034.116.01.RO
	034.116.01.VI
	034.116.01.FU
	034.116.01.VE
	034.116.01.NE
	034.116.01.BL

Ducha masaje  
5 tipos de chorro

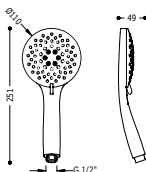

l/m:  $\rho$   $\rho$   $\rho$   $\rho$   $\rho$

Cr	299.749.01
----	------------

Ducha masaje  
3 tipos de chorro

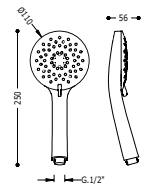

l/m:  $\rho$   $\rho$   $\rho$

Cr	299.749.02
----	------------





Ducha masaje  
3 tipos de chorro

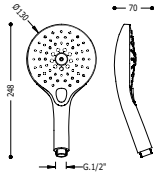

l/m: **130**  
7 8 5  
Cr | 299.749.03

Ducha masaje  
3 tipos de chorro

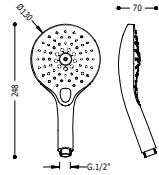

l/m: **130**  
7 8 5  
Bl-Cr | 299.749.04

Ducha masaje  
3 tipos de chorro



l/m: **110**  
8,8 9,6 8,8  
Bl-Cr | 299.749.05



Ducha masaje  
3 tipos de chorro

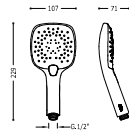

l/m: **107**  
8,2 8,6 8,1  
Bl-Cr | 299.749.06



JETS

Ref.:

3 jets empotrados de hidromasaje  
140x45 mm.

3 jets empotrados de hidromasaje  
140x45 mm.

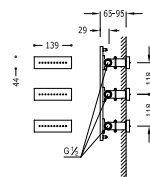

U/m: 7,9  
Cr | 299.515.04

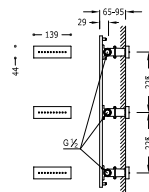

U/m: 7,9  
Cr | 299.515.05



3 jets empotrados de hidromasaje  
80x80 mm.

3 jets empotrados de hidromasaje  
80x80 mm.

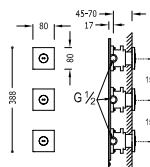

U/m: 10  
Cr | 299.515.06

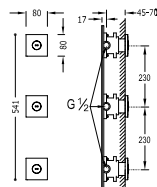

U/m: 10  
Cr | 299.515.07



## INSTALACIÓN RECOMENDADA

REF. 299.515.04  
REF. 299.515.06

REF. 299.515.05  
REF. 299.515.07

**SOPORTES CON TOMA PARED**

Ref.:

**Soporte para ducha BLOCK SYSTEM**

con toma de agua a pared regulable en profundidad, válvula antirretorno, cuerpo empotrado incluido y perfil de instalación.

**Soporte para ducha**

con toma de agua a pared y válvula antirretorno.

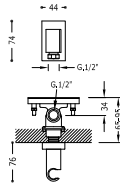

Cr 207.182.02



Cr 207.182.01

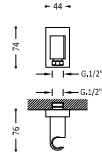

**Soporte para ducha**

con toma pared

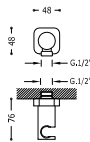

Ac	200.182.01.AC	
	200.182.01.AM	
	200.182.01.NA	
	200.182.01.RO	
	200.182.01.VI	
	200.182.01.FU	
	200.182.01.VE	
	200.182.01.NE	
	200.182.01.BL	

**SOPORTES ORIENTABLES**

**Soporte orientable redondo**

Latón



	061.839.01.AM	<input type="checkbox"/>
	061.839.01.NA	<input type="checkbox"/>
	061.839.01.RO	<input type="checkbox"/>
	061.839.01.VI	<input type="checkbox"/>
	061.839.01.FU	<input type="checkbox"/>
	061.839.01.VE	<input type="checkbox"/>
	061.839.01.NE	<input type="checkbox"/>
	061.839.01.BL	<input type="checkbox"/>





## ESPACIO DUCHA ESPACIO BAÑERA



Termostáticas

236

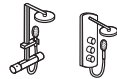

Conjuntos termostáticos

250



Monomandos

270



Programa de duchas

293

[www.tresgriferia.com](http://www.tresgriferia.com)



**RECAMBIOS**  
DE LOS ARTÍCULOS EN  
[www.tresgriferia.com](http://www.tresgriferia.com)

# TERMOSTÁTICAS DE ÚLTIMA GENERACIÓN

## Comparación entre una termostática convencional y una termostática con el sistema touch-cool®



**Termostática convencional.** El cartucho está en el volante derecho. El circuito interno del agua provoca que el agua caliente toque con la superficie y caliente el grifo.



**Termostática con sistema touch-cool®.** El cartucho está en el volante izquierdo. El circuito interno del agua provoca que el agua fría sea la que toque con la superficie y de este modo el grifo siempre está frío al tacto, evitando quemaduras.

La grifería termostática de TRES proporciona una temperatura constante del agua en el mínimo tiempo, reduciendo el consumo energético y de agua, e incorpora su sistema antiquemaduras touch-cool® (la grifería con este sistema se indica con el correspondiente símbolo).



## Ventajas



**Inversor integrado** en el volante regulador de caudal, tanto para 2 como para 3 vías.



**Excéntricas** con silenciador y filtro. Evita la entrada de suciedad, que se traduce en menos averías y una vida más larga.



**Cartucho distribuidor** con tres funciones: llave de cierre, inversor y regulador de caudal.



**Control de temperatura**  
Con botón de seguridad que restringe la temperatura a 38°C.



**Fiabilidad del cartucho** al ser un cuerpo totalmente anticálcico, insensible a las deposiciones de cal.

## Comparación de cartuchos (intercambiables)



**Instant 57®**  

Cartucho de difícil obstrucción, alta durabilidad y con protección anticálcica.

Caudal: 50-55 l/m



**Instant 77®**   

El cartucho garantiza un caudal de agua constante a la temperatura deseada de  $\pm 1$  grado ante variaciones de presión y/o temperatura. Concebido para la desinfección de la legionela.

Caudal: 30-35 l/m

Los símbolos indican, en cada referencia, la tecnología que utiliza el cartucho en cada termostática.

## Limpieza fácil del cartucho

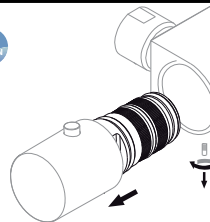

Con la tecnología **easy clean®**, TRES ofrece la posibilidad de limpiar fácilmente el cartucho en caso de obstrucción sin perder su calibración.

**Ducha CUADRO termostática**

(Ducha de mano anticalcárea (006.639.01) con soporte orientable y flexo SATIN (91.34.609.15)).



CUADRO

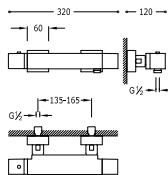

CUADRO

91.06.161.10	IA	REBAJADA	
Cr	1.07.164		

CUADRO

91.06.161.10	IA	REBAJADA	
Cr	1.07.164.9		



**Ducha LOFT termostática**

(Ducha de mano anticalcárea (034.639.01) con soporte orientable y flexo SATIN (91.34.609.15)).



LOFT

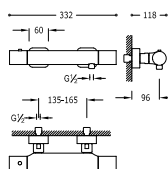

LOFT

299.195.03	REBAJADA	
Cr	200.164.01	

LOFT

299.195.03	REBAJADA	
Cr	200.164.09	



**Ducha MAX termostática**

(Ducha de mano anticalcárea con soporte orientable y flexo SATIN (91.34.609.15)).



CLASS MAX

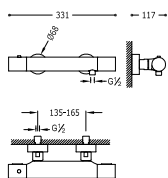

MAX/CLASS

299.195.03	REBAJADA	
Cr	061.162.01	

MAX

299.195.03		
Cr	061.162.09	

CLASS

299.195.03	REBAJADA	
Cr	205.164.01.9	



**Ducha LEX/ALPLUS termostática**

(Ducha de mano masaje Ø 100 mm. (5 funciones) (1.34.748) con soporte orientable. Flexo SATIN (91.34.609.15)).



LEX/ALPLUS

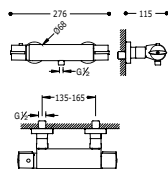

LEX/ALPLUS

91.81.161.10	IA	IB	REBAJADA
Cr	1.81.164		

LEX/ALPLUS

91.81.161.10	IA	IB	REBAJADA
Cr	1.81.164.9		





**Ducha ECO-TERM termostática**

(Ducha de mano anticálcarea (91.34.725) con soporte orientable y flexo SATIN (91.34.609.15)).

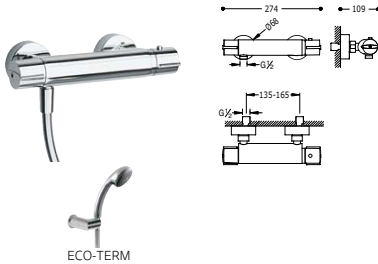

ECO-TERM  
Cr | 299.195.04 | |  
Cr | **1.90.186** |

ECO-TERM  
Cr | 299.195.04 | |  
Cr | **090.186.01** |



**Ducha FLAT termostática**

(Ducha de mano anticálcarea (1.34.617) con soporte orientable y flexo doble engatillado (91.34.828)).

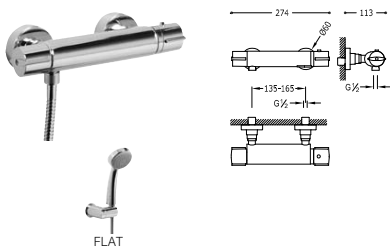

FLAT  
Cr | 299.195.08 | |  
Cr | **204.196.01** |

FLAT  
Cr | 299.195.08 | |  
Cr | **204.196.03** |



**Ducha BASIC termostática**

(Ducha de mano anticálcarea (1.34.821) con soporte orientable y flexo SATIN (91.34.609.15)).

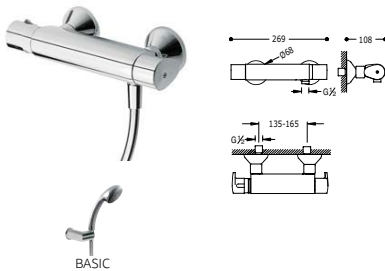

BASIC  
Cr | 91.94.172 | |  
Cr | **1.90.162** |

BASIC  
Cr | 91.94.172 | |  
Cr | **1.90.162.9** |



**Ducha termostática**

Ducha de mano anticálcarea (299.631.03) con soporte orientable y flexo SATIN (91.34.609.15). Indicado para personas con discapacidades físicas

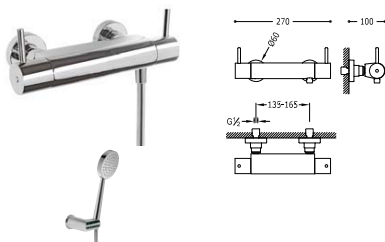

|  
299.195.09  
Cr | **090.264.01** |

|  
299.195.09  
Cr | **090.964.01** |



TERMOSTÁTICAS DE SUPERFICIE

Ref.:

Bañera- ducha CUADRO termostática

con cascada (Ducha de mano anticalcárea (006.639.01) con soporte orientable y flexo SATIN (91.34.609)).

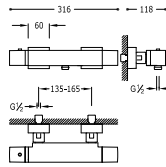

CUADRO	91.06.161.10	REGRABER	
Cr	1.07.174		

CUADRO	91.06.161.10	REGRABER	
Cr	1.07.174.9		



Bañera- ducha LOFT termostática

con cascada (Ducha de mano anticalcárea (034.639.01) con soporte orientable y flexo SATIN (91.34.609)).

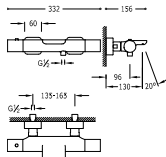

LOFT	299.195.03		
Cr	200.174.01		

LOFT	299.195.03		
Cr	200.174.09		



Bañera- ducha MAX termostática

con cascada (Ducha de mano anticalcárea con soporte orientable y flexo SATIN (91.34.609)).

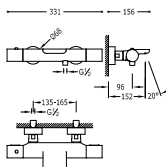

MAX/CLASS	299.195.03	REGRABER	
Cr	061.172.01		

MAX	299.195.03		
Cr	061.172.09		



Bañera- ducha LEX/ALPLUS termostática

(Ducha móvil masaje Ø 100 mm. (5 funciones) (1.34.748) con soporte orientable y flexo SATIN (91.34.609)).

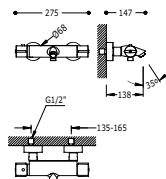

LEX/ALPLUS	91.81.161.10	REGRABER	
Cr	1.81.174		

LEX/ALPLUS	91.81.161.10	REGRABER	
Cr	1.81.174.9		



Ref.:

**Bañera-ducha BASIC termostática**

(Ducha de mano anticalcárea (1.34.821) con soporte orientable y flexo SATIN (91.34.609)).

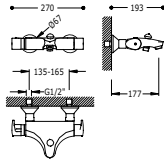

BASIC	91.34.172	91.34.821	91.34.609	91.34.609
	Cr	1.90.172		

BASIC	91.34.172	91.34.821	91.34.609	91.34.609
	Cr	1.90.172.9		



**Bañera-ducha termostática**

Ducha de mano anticalcárea (299.631.03) con soporte orientable y flexo SATIN (91.34.609). Indicado para personas con discapacidades físicas

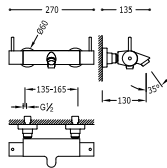

299.195.09	91.34.609	91.34.609
Cr	090.274.01	

299.195.09	91.34.609	91.34.609
Cr	090.974.01	



**Codo adaptador baño-ducha**

2 unidades con silenciador

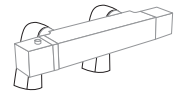
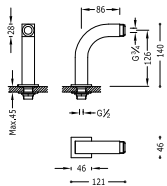

Cr	299.870.02
----	------------

**Codo adaptador baño-ducha**

2 unidades con silenciador

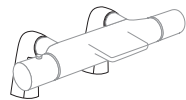
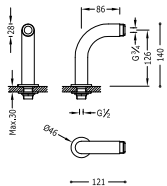

Cr	299.870.01
----	------------

**Tomas de agua a suelo de bañera**

2 unidades con soporte ducha giratorio

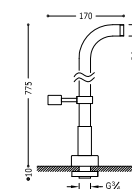

Cr	1.61.194
----	----------











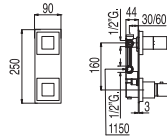
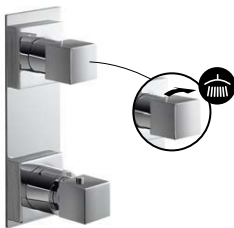



TERMOSTÁTICAS EMPOTRADAS

Ref.:

Termostática empotrar BLOCK SYSTEM (1 vía)

PARA 1 VÍA



CUADRO/SLIM	 299.250.55	 BELGARA	
Cr	1.07.250		
MAX	 299.250.55		
Cr	061.250.01		
LOFT	 299.250.55	 BELGARA	
Cr	200.250.01		
BIMAX	 299.250.55	 BELGARA	
Cr	1.63.250		



PARA 2 VIAS

Termostática empotrar BLOCK SYSTEM (2 vías)

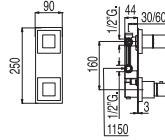
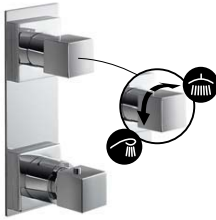

CUADRO/SLIM	299.250.55		
Cr	1.07.251		
LOFT	299.250.55		
Cr	200.250.02		
BIMAX	299.250.55		
Cr	1.63.251		
MAX	299.250.55		
Cr	061.250.02		
LEX	299.250.55		
Cr	1.81.251		

PARA 3 VIAS

Termostática empotrar BLOCK SYSTEM (3 vías)

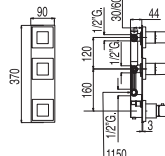
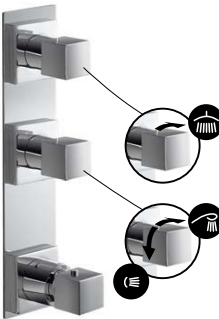

CUADRO/SLIM	299.250.55		
Cr	1.07.252		
MAX	299.250.55		
Cr	061.250.03		
LOFT	299.250.55		
Cr	200.250.03		
BIMAX	299.250.55		
Cr	1.63.252		

PARA 4 VIAS

Termostática empotrar BLOCK SYSTEM (4 vías)

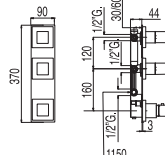
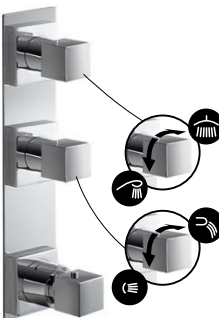

CUADRO/SLIM	299.250.55		
Cr	1.07.253		
MAX	299.250.55		
Cr	061.250.04		
LOFT	299.250.55		
Cr	200.250.04		
BIMAX	299.250.55		
Cr	1.63.253		

## TERMOSTÁTICA EMPOTRADA DE DISEÑO COMPACTO



**1** **Fácil montaje**  
Sin tornillos a la vista. Instalación óptima para tabiquería de pladur y de obra.

**2** **Empotramiento regulable**  
Entre 20 / 50 ó 60 mm de cuerpo empotrado. Solo se necesitan 60 mm de profundidad.

**3** **Control de temperatura**  
Con botón de seguridad que restringe la temperatura a 38°C.

**4** **Inversor integrado**  
Invierte la salida de agua entre la ducha de mano y la ducha mural o activa la doble función del rociador.

**TERMOSTÁTICAS EMPOTRADAS (COMPACT)**

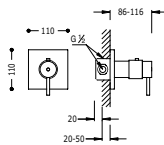

**Termostática de empotrar ducha**  
con cierre y regulación de caudal.  
- Cuerpo empotrado incluido

91.04.552  
Cr | **1.90.647**

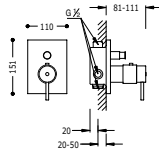

**Termostática de empotrar baño-ducha**  
con cierre y regulación de caudal.  
- Cuerpo empotrado incluido

91.04.552  
Cr | **1.90.652**

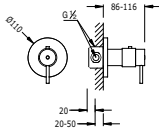

**Termostática de empotrar ducha**  
con cierre y regulación de caudal.  
- Cuerpo empotrado incluido

91.04.552  
Cr | **1.90.547**

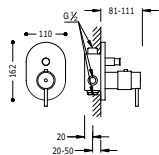

**Termostática de empotrar baño-ducha**  
con cierre y regulación de caudal.  
- Cuerpo empotrado incluido

91.04.552  
Cr | **1.90.552**

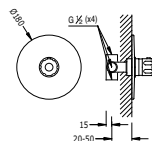

**Termostática de empotrar ducha**  
Salidas de 1/2". Importante: Se debe añadir llave o llaves de paso para el cierre y regulación de caudal.  
- Cuerpo empotrado incluido

91.04.290  
Cr | **1.90.165**

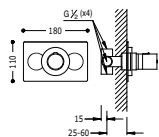

**Termostática de empotrar ducha**  
Importante: Se debe añadir llave o llaves de paso para el cierre y regulación de caudal.  
- Cuerpo empotrado incluido

91.04.161  
Cr | **1.90.150**

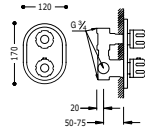

**Termostática empotrada con llave de paso**

- Salidas de 3/4". Gran caudal.
- Cuerpo empotrado incluido

91.94.290  
  
 Cr 1.90.151

N

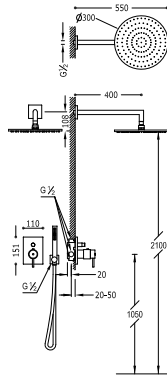

**Kit de ducha termostático empotrado**

- con cierre y regulación de caudal (2 vías).
- Cuerpo empotrado incluido
- Ducha fija Ø 300 mm. con rótula. Material Latón (1.34.137.30).
- Soporte con toma pared (205.182.01).
- Ducha móvil anticalcárea (034.116.01).
- Flexo SATIN (91.34.609.15).



91.94.552  
  
 Cr 090.960.02

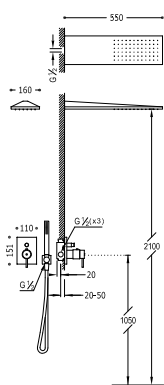

**Kit de ducha termostático empotrado**

- con cierre y regulación de caudal (2 vías).
- Cuerpo empotrado incluido
- Rociador ducha INOX a pared 160x550 mm. (299.903.03).
- Soporte con toma pared (205.182.01).
- Ducha móvil anticalcárea (034.116.01).
- Flexo SATIN (91.34.609.15).



91.94.552  
  
 Cr 090.960.01



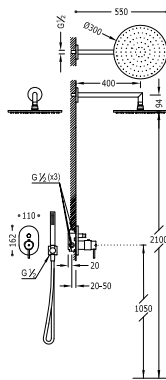

**Kit de ducha termostático empotrado**

con cierre y regulación de caudal (2 vías).

- Cuerpo empotrado incluido
- Ducha fija Ø 300 mm. con rótula. Material Latón (1.34.137.30).
- Soporte con toma pared (205.182.01).
- Ducha móvil anticalcárea (034.116.01).
- Flexo SATIN (91.34.609.15).



91.94552  
Cr | **1.90.970**

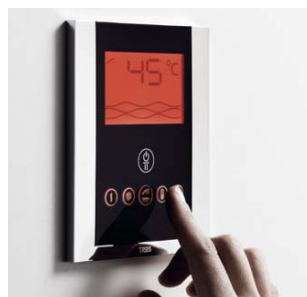

### Panel termostático electrónico

- El sistema de ducha digital incorpora 5 niveles de caudal (cantidad de agua) y controla la temperatura entre 25°C y 46°C.
- El mezclador digital se apagará automáticamente cuando el producto esté continuamente abierto durante más de 15 minutos.
- En caso de posibles fallos en la alimentación del agua fría, el sistema se bloquea y corta el paso del agua. Sistema antiquemaduras.

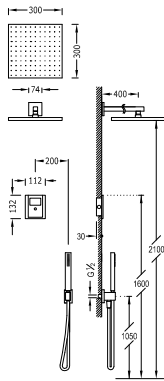

**Kit electrónico de ducha termostático empotrado  
SHOWER TECHNOLOGY**

- Centralita termostática electrónica incluida (2 vías).
- Ducha fija 300x300 mm. con rótula. Material Latón (1.34.138.30).
- Soporte con toma pared (006.182.01).
- Ducha móvil anticalcárea (202.639.01).
- Flexo SATIN (91.34.609.15).



Cr | 092.865.08

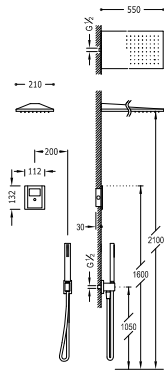

**Kit electrónico de ducha termostático empotrado  
SHOWER TECHNOLOGY**

- Centralita termostática electrónica incluida (2 vías).
- Rociador ducha INOX a pared 210x550 mm. (299.903.02).
- Soporte con toma pared (006.182.01).
- Ducha móvil anticalcárea (202.639.01).
- Flexo SATIN (91.34.609.15).



Cr | 092.865.02

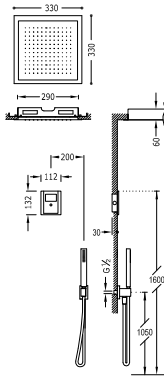

**Kit electrónico de ducha termostático empotrado  
SHOWER TECHNOLOGY**

- Centralita termostática electrónica incluida (2 vías).
- Rociador ducha a techo 330x330 mm. Material Latón. (1.34.714).
- Soporte con toma pared (006.182.01).
- Ducha móvil anticalcárea (202.639.01).
- Flexo SATIN (91.34.609.15).



Cr | 092.865.01

## ESPECIALISTAS EN CONJUNTOS TERMOSTÁTICOS

### Calidad y control total

Con infinitas combinaciones posibles, siguiendo diseños redondos o cuadrados, tanto para la ducha como para la bañera, TRES se ha especializado en la fabricación de conjuntos de ducha, que otorgan presencia en el baño y permiten grandes momentos de relax bajo el agua. Con acabados de calidad y múltiples funciones para hacer de la ducha o el baño el momento preferido del día.





**Gran variedad de rociadores**  
De latón, con rótula orientable (22°).



**Barra telescópica** que permite definir la altura del rociador, según cada necesidad.

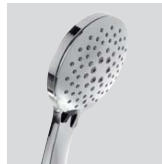

**Duchas de mano**  
Con distintas funciones.

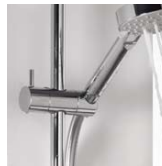

**Soporte orientable**  
Y con altura regulable.











**Inversor integrado** en el volante regulador de caudal, tanto para 2 como para 3 vías.



**Control de temperatura**  
Con botón de seguridad que restringe la temperatura a 38°C.







# CONJUNTOS PERSONALIZADOS



 l/m: 11 Cr 1.34.138.26	 l/m: 12 Cr 299.632.02	 l/m: 11 Cr 299.632.01	 l/m: 11 Cr 1.34.137.30
 l/m: 11 Cr 1.34.138.30	 l/m: 14 Cr 299.632.03	 l/m: 11 Cr 1.34.137.26	 l/m: 15 Cr 299.632.04

+



 l/m: 16 Cr 1.34.611	 l/m: 16, 16.5, 15.5, 16, 11 Cr 1.34.748		
 l/m: 15 Cr 1.34.612	 l/m: 12 Cr 299.631.08	 l/m: 6 Cr 299.631.07	 l/m: 9.5 Cr 299.748.02

+



 91.06.161.10 Cr 007.495.01	 91.81.161.10 Cr 090.495.01	 299.195.03 Cr 205.495.01	 299.195.03 Cr 081.495.01
--	---	--	--

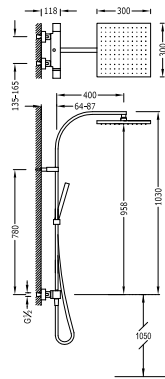

**Conjunto ducha CUADRO termostática**

- Ducha fija 300x300 mm. con rótula. Material Latón (1.34.138.30).
- Ducha móvil anticalcárea (006.639.01).
- Flexo SATIN (91.34.609.15).
- Inversor integrado en el regulador de caudal.



91.06.161.10

Cr | 1.07.395

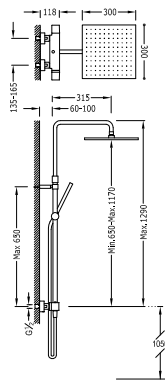

**Conjunto ducha CUADRO termostática**

- Ducha fija 300x300 mm. con rótula. Material Latón (1.34.138.30).
- Ducha móvil anticalcárea (006.639.01).
- Flexo SATIN (91.34.609.15).
- Barra telescópica.
- Inversor integrado en el regulador de caudal.



91.06.161.10

Cr | 007.195.01

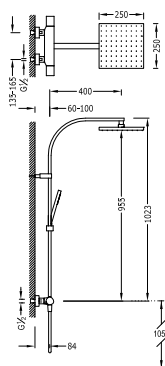

**Conjunto ducha CLASS termostática**

- Ducha fija 250x250 mm. con rótula. (1.34.138.26).
- Ducha móvil anticalcárea (299.631.08).
- Flexo SATIN (91.34.609.15).
- Inversor integrado en el regulador de caudal.



299.195.03

Cr | 205.395.01

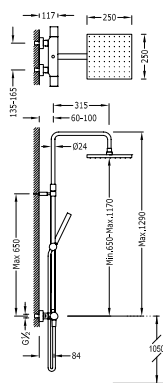

**Conjunto ducha CLASS termostática**

- Ducha fija 250x250 mm. con rótula. (1.34.138.26).
- Ducha móvil anticalcárea (299.631.08).
- Flexo SATIN (91.34.609.15).
- Barra telescópica.
- Inversor integrado en el regulador de caudal.



299.195.03

Cr 205.385.01

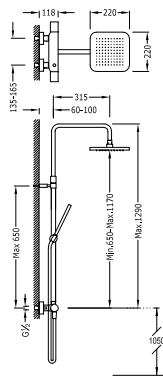

**Conjunto ducha LOFT termostática**

- Ducha fija 220x220 mm. con rótula. (299.632.06).
- Ducha móvil anticalcárea (034.639.01).
- Flexo SATIN (91.34.609.15).
- Barra telescópica.
- Inversor integrado en el regulador de caudal.



299.195.03

Cr 200.195.01

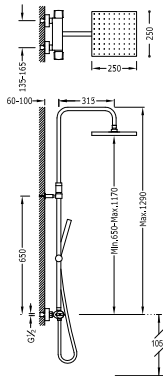

**Conjunto ducha LEX termostática**

- Ducha fija 250x250 mm. con rótula. (1.34.138.26).
- Ducha móvil anticalcárea (006.639.01).
- Flexo SATIN (91.34.609.15).
- Barra telescópica.
- Inversor integrado en el regulador de caudal.



91.81.161.10

Cr 1.90.213



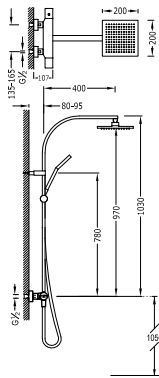

**Conjunto ducha FLAT termostática**

- Ducha fija 200x200 mm. con rótula.
- Ducha anticalcárea 80x80 mm. (1.34.612).
- Flexo SATIN (91.34.609.15).
- Inversor integrado en el regulador de caudal.



299.195.08

Cr | 204.395.01 |

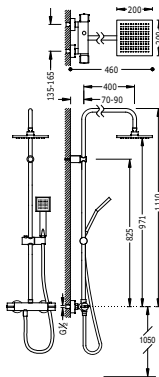

**Conjunto ducha FLAT termostática**

- Ducha fija 200x200 mm. con rótula.
- Ducha anticalcárea 80x80 mm. (1.34.612).
- Flexo SATIN (91.34.609.15).
- Inversor integrado en el regulador de caudal.



299.195.08

Cr | 204.387.02 |

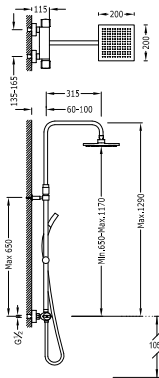

**Conjunto ducha FLAT termostática**

- Ducha fija 200x200 mm. con rótula.
- Ducha anticalcárea 80x80 mm. (1.34.612).
- Flexo SATIN (91.34.609.15).
- Barra telescópica.
- Inversor integrado en el regulador de caudal.



299.195.08

Cr | 204.387.04 |

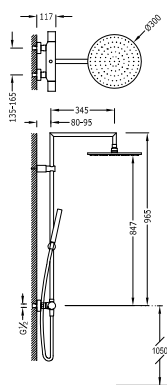

**Conjunto ducha MAX termostática**

- Ducha fija Ø 300 mm. con rótula. Material Latón (1.34.137.30).
- Ducha móvil anticalcárea (034.116.01).
- Flexo SATIN (91.34.609.15).
- Inversor integrado en el regulador de caudal.



299.195.03

Cr 061.393.01

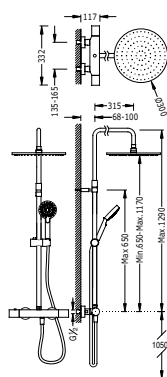

**Conjunto ducha MAX termostática**

- Ducha fija Ø 300 mm. con rótula. Material Latón (1.34.137.30).
- Ducha móvil anticalcárea (299.748.02).
- Flexo SATIN (91.34.609.15).
- Barra telescópica.
- Inversor integrado en el regulador de caudal.



299.195.03

Cr 061.210.01

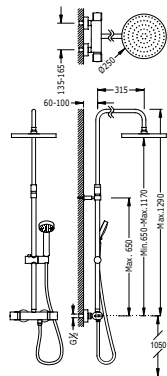

**Conjunto ducha LEX/ALPLUS termostática**

- Ducha fija Ø 250 mm. con rótula. (1.34.137.26).
- Ducha móvil masaje Ø 100 mm. (5 funciones) (1.34.748)
- Flexo SATIN (91.34.609.15).
- Barra telescópica.
- Inversor integrado en el regulador de caudal.



91.81.161.10

Cr 1.90.214

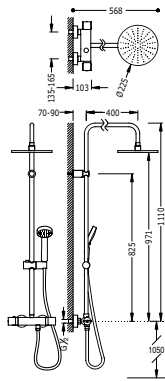

**Conjunto ducha LEX/ALPLUS termostática**

- Ducha fija Ø 225 mm. con rótula. (299.632.01).
- Ducha móvil masaje Ø 100 mm. (5 funciones) (1.34.748).
- Flexo SATIN (91.34.609.15).
- Inversor integrado en el regulador de caudal.



91.81.161.10  
Cr | **1.81.385**

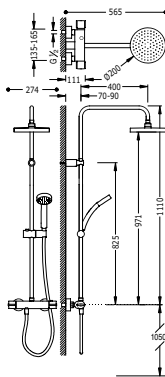

**Conjunto ducha FLAT termostática**

- Ducha fija Ø 200 mm. con rótula.
- Ducha anticalcárea Ø 80 mm. (1.34.617).
- Flexo SATIN (91.34.609.15).
- Inversor integrado en el regulador de caudal.



299.195.08  
Cr | **204.387.01**

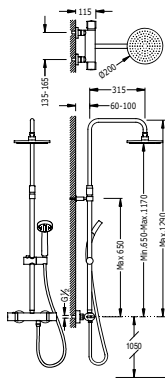

**Conjunto ducha FLAT termostática**

- Ducha fija Ø 200 mm. con rótula.
- Ducha anticalcárea Ø 80 mm. (1.34.617).
- Flexo SATIN (91.34.609.15).
- Barra telescópica.
- Inversor integrado en el regulador de caudal.



299.195.08  
Cr | **204.387.03**

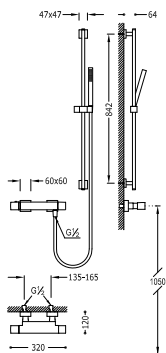

**Kit de ducha CUADRO termostático**

- Barra deslizante long. 842 mm. (1.07.935).
- Ducha móvil anticálcarea (006.639.01).
- Flexo SATIN (91.34.609.15).



91.06.161.10

Cr 007.164.02

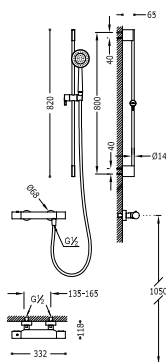

**Kit de ducha MAX termostático**

- Barra deslizante long. 800 mm. (034.637.01).
- Ducha móvil anticálcarea (299.631.03).
- Flexo SATIN (91.34.609.15).



299.195.03

Cr 062.164.02

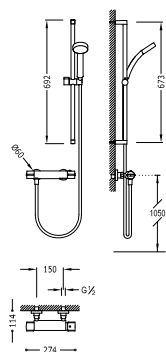

**Kit de ducha FLAT termostático**

- Barra deslizante Ø 20,6 mm. long. 673 mm. (034.637.06).
- Ducha anticálcarea Ø 80 mm. (1.34.617).
- Flexo doble engatillado (91.34.828).



299.195.08

Cr 204.196.02

**Kit de ducha LEX/ALPLUS termostático**

- Ducha móvil masaje.
- Barra deslizante PRACTIC-MAX.
- Ducha LEX/ALPLUS termostática.

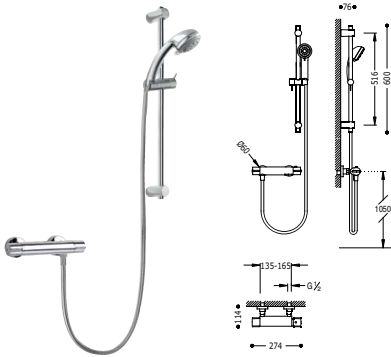

Cr | 1.83.395

**Kit de ducha ECO-TERM termostática**

- Barra deslizante ECO (Ø 25 mm, long 600 mm).
- Ducha móvil masaje Ø 100 mm, (5 posiciones).
- Flexo SATIN.

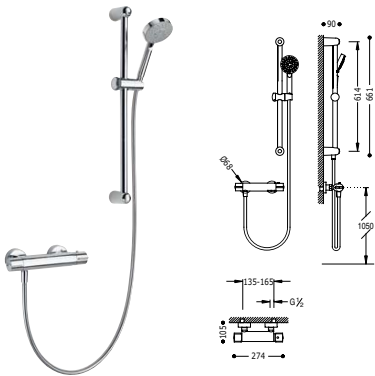

299.195.04  
Cr | 090.186.02

**Conjunto ducha CUADRO termostática**

- Ducha fija 250x250 mm, con rótula. (1.34.138.26).
- Ducha móvil anticaída (006.639.01).
- Flexo SATIN (91.34.609.15).

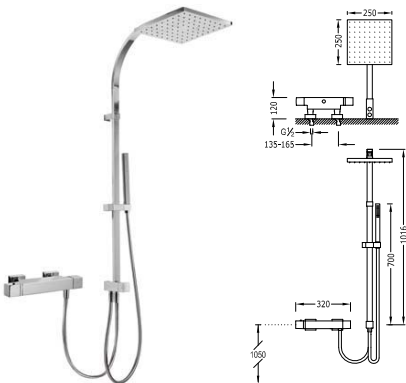

91.06.161.10  
Cr | 007.385.01

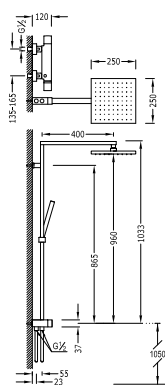

**Conjunto ducha CUADRO termostática**

- Ducha fija 250x250 mm. con rótula. (1.34.138.26).
- Ducha móvil anticalcárea (006.639.01).
- Flexo SATIN (91.34.609.15).



91.06.161.10  
Cr 1.07.964

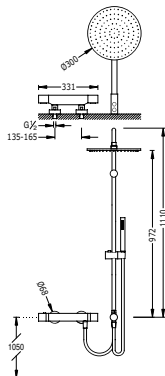

**Conjunto ducha MAX termostática**

- Ducha fija Ø 300 mm. con rótula. Material Latón (1.34.137.30).
- Ducha móvil anticalcárea (034.116.01)
- Flexo SATIN (91.34.609.15).



299.195.03  
Cr 061.385.01

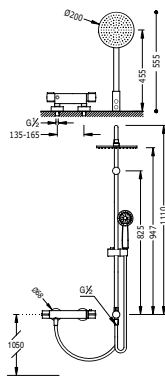

**Conjunto ducha FLAT termostática**

- Ducha fija Ø 200 mm. con rótula (299.632.12).
- Ducha anticalcárea Ø 80 mm. (1.34.617).
- Flexo SATIN (91.34.609.15).



299.195.08  
Cr 204.385.01

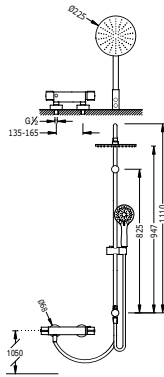

**Conjunto ducha ECO-TERM termostática**

- Ducha fija Ø 225 mm. con rótula. (299.632.01).
- Ducha móvil masaje Ø 100 mm. (5 funciones) (1.34.748).
- Flexo SATIN (91.34.609.15).

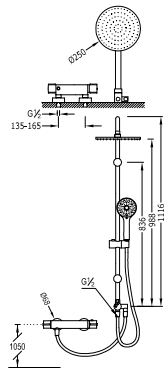

**Conjunto ducha ECO-TERM termostática**

- Barra deslizable sobre sus soportes de pared.
- Ducha fija Ø 250 mm. con rótula (1.34.137.26).
- Ducha móvil masaje Ø 100 mm. (5 funciones).
- Flexo SATIN (91.34.609.15).

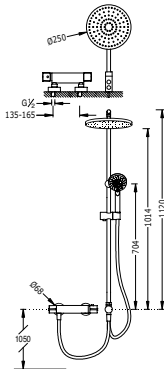

**Conjunto ducha ECO-TERM termostática**

- Ducha fija Ø 250 mm. con rótula (1.34.137.26).
- Ducha móvil masaje Ø 100 mm. (5 funciones).
- Flexo SATIN (91.34.609.15).



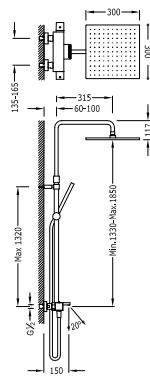

**Conjunto bañera-ducha CUADRO termostática**

- Ducha fija 300x300 mm. con rótula. Material Latón (1.34.138.30).
- Ducha móvil anticalcárea (006.639.01).
- Flexo SATIN (91.34.609).
- Barra telescópica.



299.312.01

Cr 007.312.01

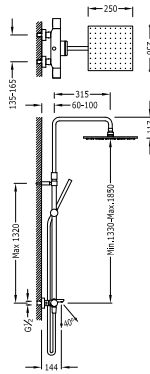

**Conjunto bañera-ducha CLASS termostática**

- Ducha fija 250x250 mm. con rótula. (1.34.138.26).
- Ducha móvil anticalcárea (299.631.08).
- Flexo SATIN (91.34.609).
- Barra telescópica.



299.195.03

Cr 205.312.01

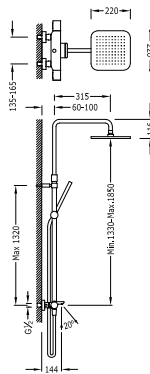

**Conjunto bañera-ducha LOFT termostática**

- Ducha fija 220x220 mm. con rótula. (299.632.06).
- Ducha móvil anticalcárea (034.639.01).
- Flexo SATIN (91.34.609).
- Barra telescópica.



299.195.03

Cr 200.312.01



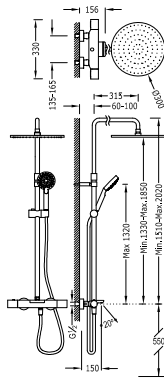

**Conjunto bañera-ducha MAX termostática**

- Ducha fija Ø 300 mm. con rótula. Material Latón (1.34.137.30).
- Ducha móvil anticalcárea (299.748.02).
- Flexo SATIN (91.34.609).
- Barra telescópica.



299.195.03

Cr | **062.312.01** |

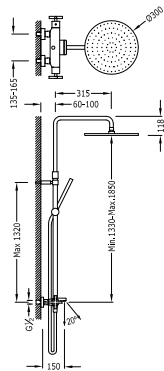

**Conjunto bañera-ducha BIMAX termostática**

- Ducha fija Ø 300 mm. con rótula. Material Latón (1.34.137.30).
- Ducha móvil anticalcárea (034.116.01).
- Flexo SATIN (91.34.609).
- Barra telescópica.



299.312.02

Cr | **063.312.01** |

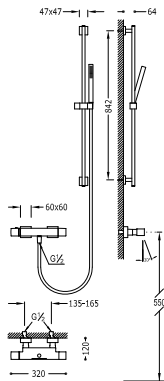

**Kit de baño-ducha CUADRO termostático**

- Barra deslizante long. 842 mm. (1.07.935).
- Ducha móvil anticalcárea (006.639.01).
- Flexo SATIN (91.34.609).



91.06.161.10

Cr | **007.174.02** |

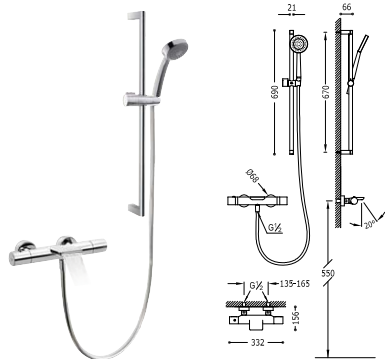

**Kit de baño-ducha MAX termostático**

- Barra deslizante Ø 20,6 mm. long. 673 mm. (034.637.06).
- Ducha móvil anticalcárea (299.631.03).
- Flexo SATIN (91.34.609).



299.195.03

Cr 062.174.02

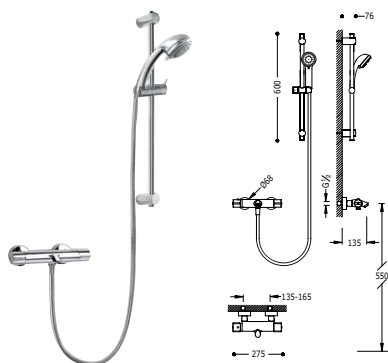

**Kit de baño-ducha LEX/ALPLUS termostático**

- Barra deslizante long. 516 mm. (1.61.835).
- Ducha masaje, 3 posiciones. (1.34.823).



91.94.161.10

Cr 1.83.398

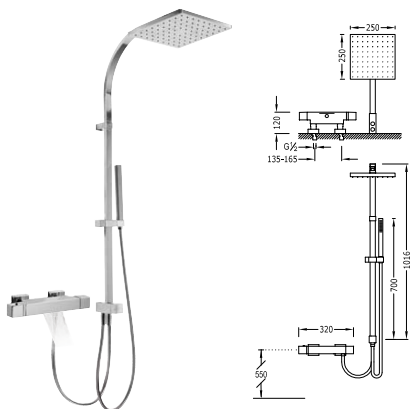

**Conjunto bañera-ducha CUADRO termostática**

- Ducha fija 250x250 mm. con rótula. (1.34.138.26).
- Ducha móvil anticalcárea (006.639.01).
- Flexo SATIN (91.34.609.15).



91.06.161.10

Cr 007.385.02



**Conjunto bañera-ducha MAX termostática**

- Ducha fija Ø 300 mm. con rótula. Material Latón (1.34.137.30).
- Ducha móvil anticalcárea (034.116.01).
- Flexo SATIN (91.34.609.15).

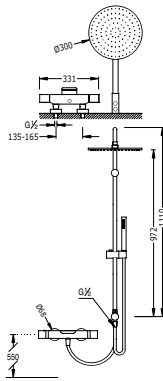

Cr | **061.385.02** |

**ALARGADERAS**

**Alargaderas**

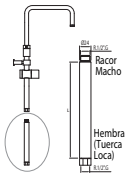

(para ref.: 90.312, 90.311, 90.310, 90.212, 90.211, 90.210, 90.213, 90.214, 87.355, 87.356, 024.164.04)

L= 300 mm.

Cr | **91.81.195.03** |

L= 650 mm.

Cr | **1.81.195.02** |

**Alargaderas**

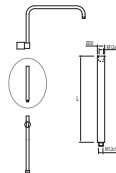

(para ref.: 012.995.01, 070.995.01, 081.192, 081.495.01, 083.192, 1.81.191, 1.81.386, 1.81.385\*)

\* posterior a mayo 2012

L= 300 mm.

Cr | **91.81.385.03** |

L= 650 mm.

Cr | **1.81.385.06** |

**Alargaderas**

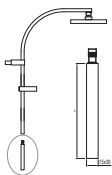

(para ref.: 1.07.395)

L= 300 mm.

Cr | **91.06.914.03** |

L= 500 mm.

Cr | **1.06.914.05** |

**Alargaderas**

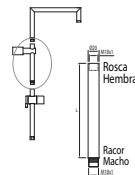

(para ref.: 90.481, 90.583, 90.281, 90.393)

L= 300 mm.

Cr | **91.34.463.03** |

L= 650 mm.

Cr | **1.34.463.02** |

**Alargaderas**

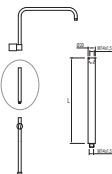

(para ref.: 90.385, 61.475, 1.81.385\*\*)

\*\* anterior a mayo 2012

L= 300 mm.

Cr | **91.34.195.03** |

L= 650 mm.

Cr | **1.34.195.02** |



## Destacamos

---



### Rociador de gran formato

Consigue una ducha que te envuelva y estimule con una agradable sensación de lluvia.

---



### Panel de Aluminio Anodizado

De fácil limpieza y máxima resistencia a la corrosión y al desgaste. No necesita mantenimiento.

---



### Ducha de mano con funciones

Aumenta el poder tonificante y revitalizador del masaje por agua combinando los diferentes chorros.

---



### Funciones simultáneas

Mandos independientes para cada función con cartucho termostático de respuesta inmediata.

---



### Jets orientables

Para un relajante masaje en cervicales, dorsales y lumbares.

---



### Montaje en ducha o bañera

Ideal para llenar bañeras, refrescar los pies...

---



COLUMNAS DE DUCHA

Ref.:

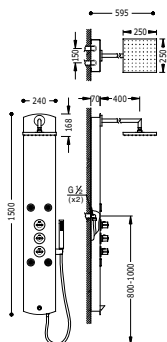

Columna de ducha termostática LEX-B

- Ducha fija 250x250 mm. con rótula. (1.34.138.26).
- Ducha móvil anticalcárea.
- Flexo SATIN (91.34.609.15).

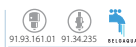

Anod 1.93.124

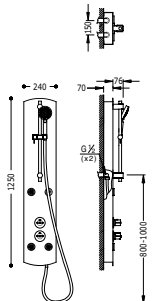

Columna de ducha termostática LEX-D

- Ducha móvil masaje.
- Flexo SATIN (91.34.609.15).

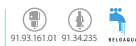

Anod 1.93.223

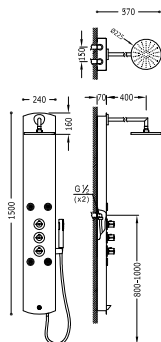

Columna de ducha termostática LEX-B

- Ducha fija Ø 225 mm. con rótula. (299.632.01).
- Ducha móvil anticalcárea.
- Flexo SATIN (91.34.609.15).

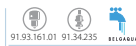

Anod 1.93.123

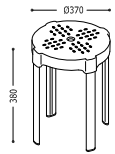

**Taburete de baño**  
Peso máximo soportado 225 kg.



034.636.28

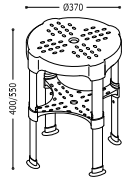

**Taburete de baño ajustable**  
Peso máximo soportado 225 kg.



034.636.29

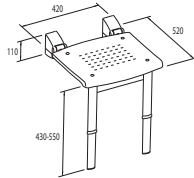

**Asiento plegable de ducha con patas**



034.636.30

# MONOMANDOS PARA LA DUCHA



## Diseño

Minimalistas y de estética moderna. Fáciles de limpiar.



## Práctico

Un solo mando abre/cierra el paso del agua, ajusta la temperatura y regula el caudal.

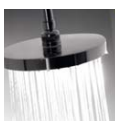

## Funcional

Invierte la salida de agua entre la ducha de mano y el rociador.



## Duradero

Tanto por la calidad del material como por su robustez.

## Ejemplo de un conjunto de superficie



## Ejemplo de un conjunto empotrado







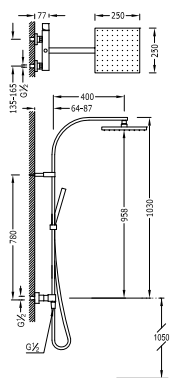

**Conjunto ducha monomando anticalcárea CUADRO**

- Ducha fija 250x250 mm. con rótula. (1.34.138.26).
- Ducha móvil anticalcárea (006.639.01).
- Flexo SATIN (91.34.609.15).



91.30.190

Cr 007.191.01

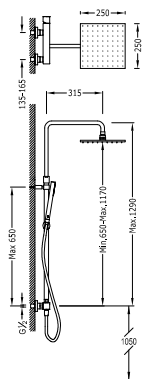

**Conjunto ducha monomando anticalcárea CUADRO**

- Ducha fija 250x250 mm. con rótula. (1.34.138.26).
- Ducha móvil anticalcárea (006.639.01).
- Flexo SATIN (91.34.609.15).
- Barra telescópica.



91.30.190

Cr 007.191.01

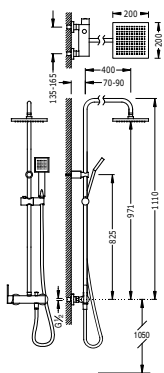

**Conjunto ducha monomando anticalcárea LEX**

- Ducha fija 200x200 mm. con rótula. (299.632.11).
- Ducha móvil anticalcárea (1.34.612).
- Flexo SATIN (91.34.609.15).



91.34.592

Cr 081.193.01

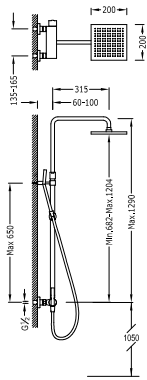

**Conjunto ducha monomando anticalcárea LEX**

- Ducha fija 200x200 mm. con rótula. (299.632.11).
- Ducha móvil anticalcárea (1.34.612).
- Flexo SATIN (91.34.609.15).
- Barra telescópica.



91.34.592

Cr | 081.197.01 |

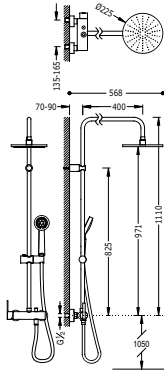

**Conjunto ducha monomando anticalcárea LEX**

- Ducha fija Ø 225 mm. con rótula. (299.632.01).
- Ducha móvil masaje Ø 100 mm. (5 funciones) (1.34.748).
- Flexo SATIN (91.34.609.15).



91.34.592

Cr | 1.81.191 |

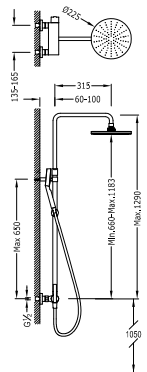

**Conjunto ducha monomando anticalcárea LEX**

- Ducha fija Ø 225 mm. con rótula. (299.632.01).
- Ducha móvil masaje Ø 100 mm. (5 funciones) (1.34.748).
- Flexo SATIN (91.34.609.15).
- Barra telescópica.



91.34.592

Cr | 081.197.02 |

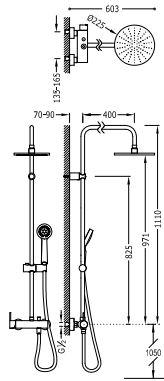

**Conjunto ducha monomando anticalcárea ALPLUS**

- Ducha fija Ø 225 mm. con rótula. (299.632.01).
- Ducha móvil anticalcárea (299.631.03).
- Flexo SATIN (91.34.609.15).



91.34.592

Cr 203.191.01

EMPOTRADOS

Ref.:



**Distribuidor empotrado de 5 vías**  
con cierre y regulación de caudal (1 entrada y 5 salidas)

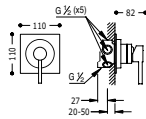

Cr | 1.34.550

MONOMANDOS EMPOTRADOS



**Kit de ducha monomando empotrado CUADRO**

- con cierre y regulación de caudal.
- Cuerpo empotrado incluido
  - Soporte con toma pared (006.182.01).
  - Ducha móvil anticalcárea (006.639.01).
  - Flexo SATIN (91.34.609.15).

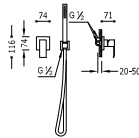

91.30.190  
Cr | 006.177.03



**Kit de ducha monomando empotrado CUADRO**

- con cierre y regulación de caudal.
- Cuerpo empotrado incluido
  - Ducha fija 300x300 mm. con rótula. Material Latón. (1.34.138.30).

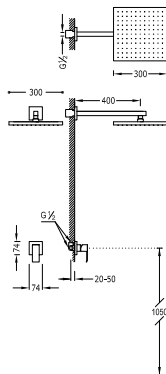

91.30.190  
Cr | 1.06.377

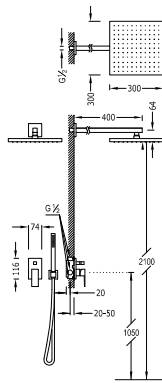

**Kit de ducha monomando empotrado CUADRO**

- con cierre y regulación de caudal.
- Cuerpo empotrado incluido
- Ducha fija 300x300 mm. con rótula. Material Latón. (1.34.138.30).
- Soporte con toma pared (006.182.01).
- Ducha móvil anticalcárea (006.639.01).
- Flexo SATIN (91.34.609.15).



91.30.190

Cr 1.06.980

N

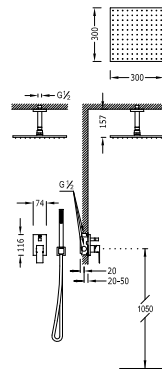
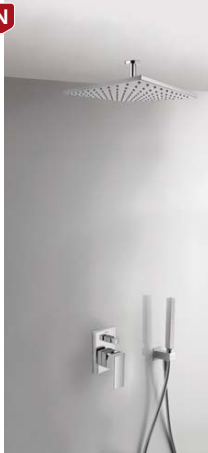

**Kit de ducha monomando empotrado CUADRO**

- con cierre y regulación de caudal.
- Cuerpo empotrado incluido
- Ducha fija 300x300 mm. con rótula. Material Latón. (1.34.138.30).
- Soporte con toma pared (006.182.01).
- Ducha móvil anticalcárea (006.639.01).
- Flexo SATIN (91.34.609.15).



91.30.190

Cr 006.180.80

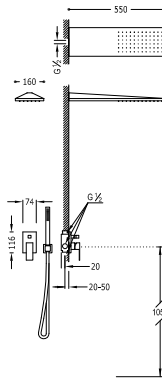

**Kit de ducha monomando empotrado CUADRO**

- con cierre y regulación de caudal.
- Cuerpo empotrado incluido
- Rociador ducha INOX a pared 160x550 mm. (299.903.03).
- Soporte con toma pared (006.182.01).
- Ducha móvil anticalcárea (006.639.01).
- Flexo SATIN (91.34.609.15).



91.30.190

Cr 006.180.03

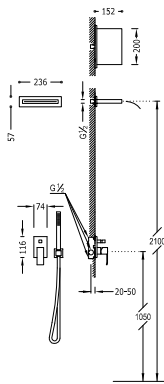

**Kit de ducha monomando empotrado CUADRO**

- con cierre y regulación de caudal.
- Cuerpo empotrado incluido
  - Ducha INOX con cascada 152x200 mm.
  - Soporte con toma pared (006.182.01).
  - Ducha móvil anticalcárea (006.639.01).
  - Flexo SATIN (91.34.609.15).



91.30.190

Cr | 006.180.06 |

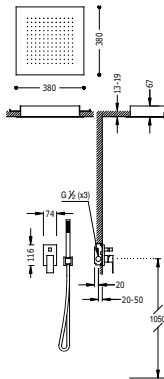

**Kit de ducha monomando empotrado CUADRO**

- con cierre y regulación de caudal.
- Cuerpo empotrado incluido
  - Rociador ducha INOX a techo 380x380 mm. (1.34.944).
  - Soporte con toma pared (006.182.01).
  - Ducha móvil anticalcárea (006.639.01).
  - Flexo SATIN (91.34.609.15).



91.30.190

Cr | 006.980.01 |

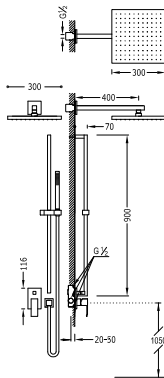

**Kit de ducha monomando empotrado CUADRO**

- con cierre y regulación de caudal.
- Cuerpo empotrado incluido
  - Ducha fija 300x300 mm. con rótula. Material Latón. (1.34.138.30).
  - Barra deslizante long. 900 mm. (1.07.935).
  - Codo toma pared (006.183.01).
  - Ducha móvil anticalcárea (006.639.01).
  - Flexo SATIN (91.34.609.15).



91.30.190

Cr | 1.06.985 |



**Kit de ducha monomando empotrado MAX**

- con cierre y regulación de caudal.
- Cuerpo empotrado incluido
- Soporte con toma pared (061.182.01).
- Ducha móvil anticalcárea (034.116.01).
- Flexo SATIN (91.34.609.15).

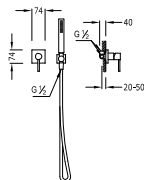

91.30.190

Cr 062.177.03



**Kit de ducha monomando empotrado MAX**

- con cierre y regulación de caudal.
- Cuerpo empotrado incluido
- Ducha fija Ø 300 mm. con rótula. (1.34.137.30). Material Latón.
- Soporte con toma pared (061.182.01).
- Ducha móvil anticalcárea (034.116.01).
- Flexo SATIN (91.34.609.15).

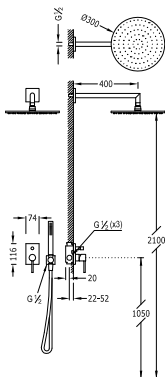

91.30.190

Cr 062.980.01



**Kit de ducha monomando empotrado MAX**

- con cierre y regulación de caudal.
- Cuerpo empotrado incluido
- Ducha fija Ø 300 mm. con rótula. (1.34.137.30). Material Latón.
- Soporte con toma pared (061.182.01).
- Ducha móvil anticalcárea (034.116.01).
- Flexo SATIN (91.34.609.15).

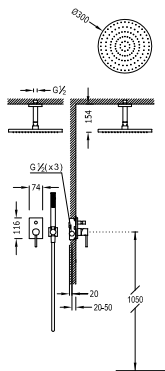

91.30.190

Cr 062.180.80



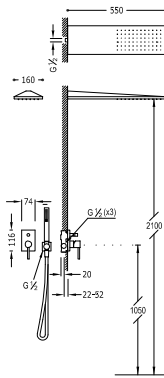

**Kit de ducha monomando empotrado MAX**

con cierre y regulación de caudal.

- Cuerpo empotrado incluido
- Rociador ducha INOX a pared 160x550 mm. (299.903.03).
- Soporte con toma pared (061.182.01).
- Ducha móvil anticalcárea (034.116.01).
- Flexo SATIN (91.34.609.15).



91.30.190

Cr 062.516.01

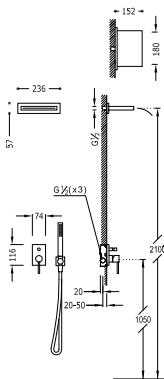

**Kit de ducha monomando empotrado MAX**

con cierre y regulación de caudal.

- Cuerpo empotrado incluido
- Ducha INOX con cascada 152x200 mm.
- Soporte con toma pared (061.182.01).
- Ducha móvil anticalcárea (034.116.01).
- Flexo SATIN (91.34.609.15).



91.30.190

Cr 062.180.05

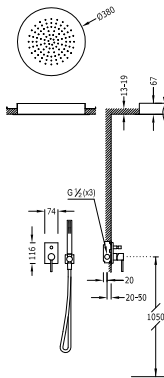

**Kit de ducha monomando empotrado MAX**

con cierre y regulación de caudal.

- Cuerpo empotrado incluido
- Rociador ducha INOX a techo Ø 380 mm. (1.34.940).
- Soporte con toma pared (061.182.01).
- Ducha móvil anticalcárea (034.116.01).
- Flexo SATIN (91.34.609.15).



91.30.190

Cr 062.180.09

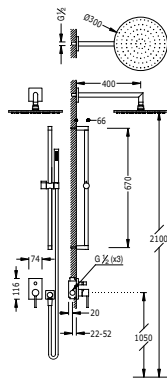

**Kit de ducha monomando empotrado MAX**

con cierre y regulación de caudal.

- Cuerpo empotrado incluido
- Ducha fija Ø 300 mm. con rúcula. Material Latón. (1.34.137.30).
- Barra deslizante long. 673 mm. (034.637.06).
- Codo toma pared (061.183.01).
- Ducha móvil anticalcárea (034.116.01).
- Flexo SATIN (91.34.609.15).



91.30.190

Cr 062.980.02

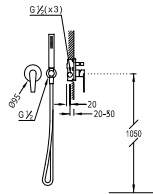

**Kit de ducha monomando empotrado CLASS**

con cierre y regulación de caudal.

- Cuerpo empotrado incluido
- Soporte con toma pared (205.182.01).
- Ducha móvil anticalcárea (299.631.08).
- Flexo SATIN (91.34.609.15).



91.30.190

Cr 205.177.02

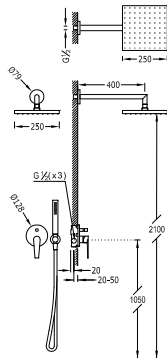

**Kit de ducha monomando empotrado CLASS**

con cierre y regulación de caudal.

- Cuerpo empotrado incluido
- Ducha fija 250x250 mm. con rúcula. (1.34.138.26).
- Soporte con toma pared (205.182.01).
- Ducha móvil anticalcárea (299.631.08).
- Flexo SATIN (91.34.609.15).



91.30.190

Cr 205.180.02



**Kit de ducha monomando empotrado CLASS**

con cierre y regulación de caudal.

- Cuerpo empotrado incluido
- Rociador ducha INOX a pared 160x550 mm. (299.903.03).
- Soporte con toma pared (205.182.01).
- Ducha móvil anticalcárea (299.631.08).
- Flexo SATIN (91.34.609.15).

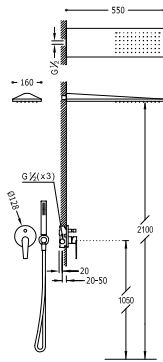

Cr | 205.180.03



**Kit de ducha monomando empotrado CLASS**

con cierre y regulación de caudal.

- Cuerpo empotrado incluido
- Ducha INOX con cascada 152x200 mm.
- Soporte con toma pared (205.182.01).
- Ducha móvil anticalcárea (299.631.08).
- Flexo SATIN (91.34.609.15).

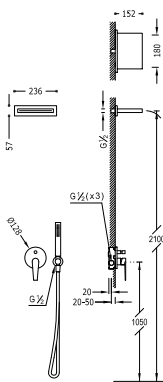

Cr | 205.180.04



**Kit de ducha monomando empotrado CLASS**

con cierre y regulación de caudal.

- Cuerpo empotrado incluido
- Ducha fija 250x250 mm. con rótula. (1.34.138.26).
- Barra deslizante long. 673 mm. (034.637.06).
- Codo toma pared (1.34.757).
- Ducha móvil anticalcárea (299.631.08).
- Flexo SATIN (91.34.609.15).

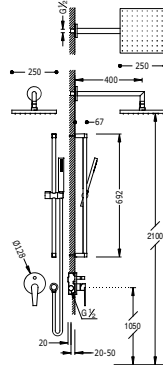

Cr | 205.180.05





**Kit de ducha monomando empotrado LOFT**

- con cierre y regulación de caudal.
- Cuerpo empotrado incluido
- Soporte con toma pared (200.182.01).
- Ducha móvil anticalcárea (034.639.01).
- Flexo SATIN (91.34.609.15).

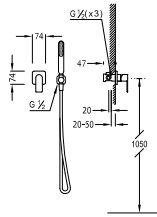

**Kit de ducha monomando empotrado LOFT**

- con cierre y regulación de caudal.
- Cuerpo empotrado incluido
- Ducha fija 220x220 mm. con rótula (299.632.06).
- Soporte con toma pared (200.182.01).
- Ducha móvil anticalcárea (034.639.01).
- Flexo SATIN (91.34.609.15).

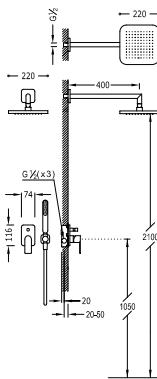

**Kit de ducha monomando empotrado LOFT**

- con cierre y regulación de caudal.
- Cuerpo empotrado incluido
- Rociador ducha INOX a pared 160x550 mm. (299.903.06).
- Soporte con toma pared (200.182.01).
- Ducha móvil anticalcárea (034.639.01).
- Flexo SATIN (91.34.609.15).

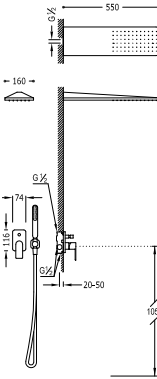

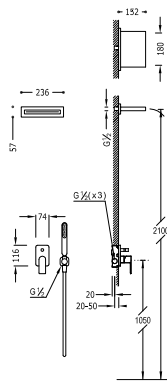

**Kit de ducha monomando empotrado LOFT**

con cierre y regulación de caudal.

- Cuerpo empotrado incluido
- Ducha INOX con cascada 152x200 mm. (299.903.04).
- Soporte con toma pared (200.182.01).
- Ducha móvil anticalcárea (034.639.01).
- Flexo SATIN (91.34.609.15).



91.30.190

Cr | 200.180.04

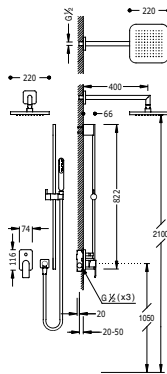

**Kit de ducha monomando empotrado LOFT**

con cierre y regulación de caudal.

- Cuerpo empotrado incluido
- Ducha fija 220x220 mm. con rótula. (299.632.06).
- Codo toma pared (200.183.01).
- Barra deslizante long. 820 mm. (034.637.01).
- Ducha móvil anticalcárea (034.639.01).
- Flexo SATIN (91.34.609.15).



91.30.190

Cr | 200.180.03

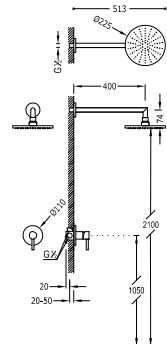

**Kit de ducha monomando empotrado ALPLUS**

con cierre y regulación de caudal.

- Cuerpo empotrado incluido
- Ducha fija Ø 225 mm. con rótula. (299.632.01).



91.34.592

Cr | 203.177.02



**Kit de ducha monomando empotrado LEX**

con cierre y regulación de caudal.

- Cuerpo empotrado incluido
- Ducha fija Ø 250 mm. con rótula. (1.34.137.26).
- Soporte con toma pared (205.182.01).
- Ducha móvil masaje Ø 100 mm. (5 funciones) (1.34.748).
- Flexo SATIN (91.34.609.15).

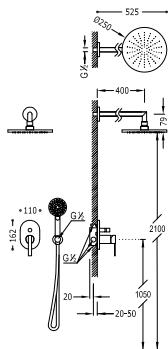

91.34.592

Cr 1.81.880.05



**Kit de ducha monomando empotrado ALPLUS**

con cierre y regulación de caudal.

- Cuerpo empotrado incluido
- Ducha fija Ø 225 mm. con rótula. (299.632.01).
- Soporte con toma pared (205.182.01).
- Ducha móvil anticálcarea (299.631.03).
- Flexo SATIN (91.34.609.15).

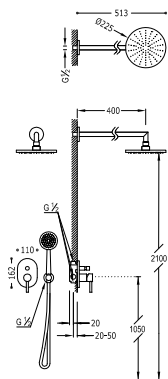

91.34.592

Cr 203.180.02



**Kit de ducha monomando empotrado ALPLUS**

con cierre y regulación de caudal.

- Cuerpo empotrado incluido
- Ducha fija Ø 225 mm. con rótula. (299.632.01).
- Barra deslizante long. 550 mm. (1.34.618).
- Codo toma pared (205.183.01).
- Ducha móvil anticálcarea (299.631.03).
- Flexo SATIN (91.34.609.15).

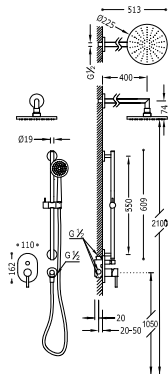

91.34.592

Cr 203.180.03

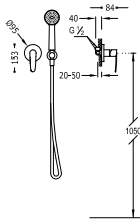

**Kit de ducha monomando empotrado FLAT**

- con cierre y regulación de caudal.
- Cuerpo empotrado incluido
- Soporte con toma pared (205.182.01).
- Ducha móvil anticalcárea (1.34.617).
- Flexo SATIN (91.34.609.15).



Cr | 204.177.02 |

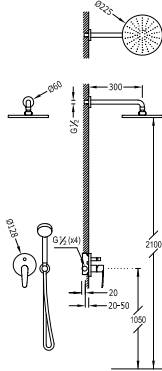

**Kit de ducha monomando empotrado FLAT**

- con cierre y regulación de caudal.
- Cuerpo empotrado incluido
- Ducha fija Ø 225 mm. con rótula. (299.632.01).
- Soporte con toma pared (205.182.01).
- Ducha móvil anticalcárea (1.34.617).
- Flexo SATIN (91.34.609.15).



Cr | 204.180.02 |

## KIT DEPÓSITO PARA BAÑERAS DE REPISA

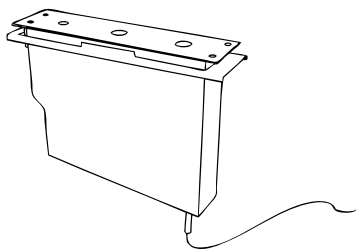

### **Facilita la instalación y garantiza la estanqueidad**

El kit depósito permite el montaje superior del grifo de repisa, facilitando su instalación.

El sistema patentado de instalación no necesita registros.

El depósito es estanco y comunica con el desagüe de la bañera para expulsar los restos de agua que se puedan introducir.

Incluye una placa de latón cromada embellecedora para mejorar el acabado de la parte visible.

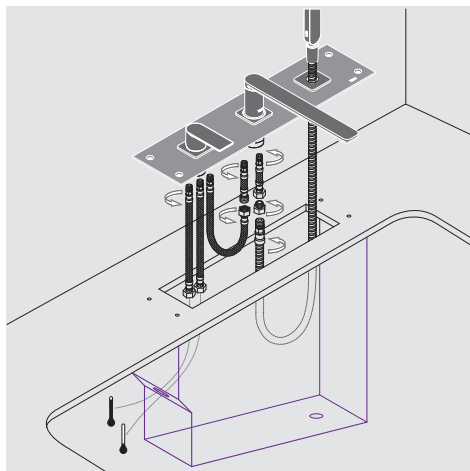





**BAÑERAS DE REPISA**

Ref.:

**Monomando bañera de repisa CUADRO**

con ducha anticaída (006.639.01).  
- Caudal: 3 bar - 13 l/m.  
- Compatible con el kit depósito ref: 200.245.01.  
- NOTA: ver longitud caño.

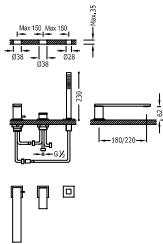

	91.30.190 (180 mm.)	
Cr	006.161.06	
	91.30.190 (220 mm.)	
Cr	006.161.04	
	91.30.190 (180 mm.)	
Cr	006.161.05	
	91.30.190 (220 mm.)	
Cr	006.161.03	



**Monomando bañera de repisa CLASS**

con ducha anticaída (299.631.08).  
- Caudal: 3 bar - 13 l/m.  
- Compatible con el kit depósito ref: 200.245.01.  
- NOTA: ver longitud caño.

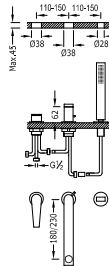

	91.30.190 (180 mm.)	
Cr	205.161.03	
	91.30.190 (230 mm.)	
Cr	205.161.01	



**Batería bañera de repisa**

Ducha móvil anticalcárea (034.116.01).

- Caudal: 3 bar - 17 l/m.

- Compatible con el kit depósito ref: 1.34.345.



Cr | 1.63.145



**Monomando bañera de repisa ALPLUS**

Ducha móvil anticalcárea (299.631.03).

- Caudal: 3 bar - 16 l/m.

- Compatible con el kit depósito ref: 203.245.01.

- NOTA: ver longitud caño.



91.34.591 (180 mm.)

Cr | 203.161.02

91.34.591 (220 mm.)

Cr | 203.161.01

**Monomando bañera de repisa CUADRO**

con caño cascada y ducha móvil anticalcárea (006.639.01).

- Caudal: 3 bar - 13 l/m.

- Compatible con el kit depósito ref: 1.06.245.

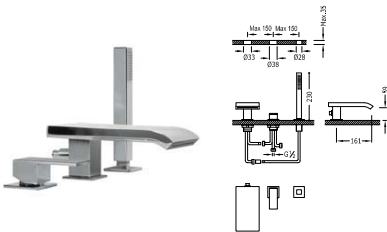

91.30.190

Cr | 1.07.161.02

91.30.190

Cr | 1.06.161.02

**Monomando bañera de repisa MAX**

con caño cascada y ducha móvil anticalcárea (034.116.01).

- Caudal: 3 bar - 17 l/m.

- Compatible con el kit depósito ref: 1.62.245.

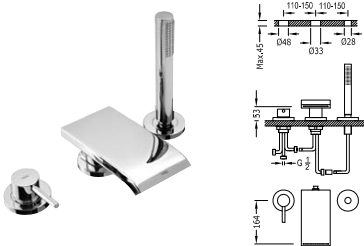

91.34.288

Cr | 061.161.01

91.34.288

Cr | 1.62.161

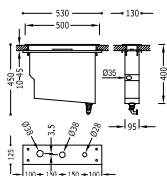

**Kit depósito para bañeras de repisa**

Fácil montaje superior. Sin registros (para ref.: 202.161.04, 202.161.02, 202.161.03, 202.161.01, 202.661.02, 202.661.01).

Cr 202.245.01

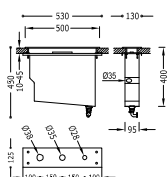

**Kit depósito para bañeras de repisa**

Fácil montaje superior. Sin registros (para ref.: 1.07.161.02, 1.06.161.02).

Cr 1.06.245

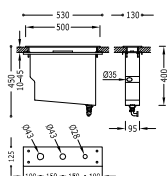

**Kit depósito para bañeras de repisa**

Fácil montaje superior. Sin registros (para ref.: 061.161.01, 1.62.161, 261.150.01, 262.150.01).

Cr 1.62.245

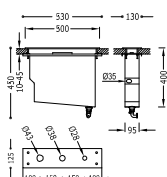

**Kit depósito para bañeras de repisa**

Fácil montaje superior. Sin registros (para ref.: 062.161.03, 062.161.02, 200.162.03, 200.162.01, 081.161.04, 081.161.03, 203.161.02, 203.161.01).

Cr 203.245.01

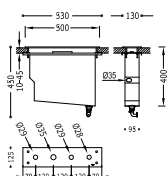

**Kit depósito para bañeras de repisa**

Fácil montaje superior. Sin registros (para ref.: 1.63.145, 1.32.145, 1.24.146).

Cr 1.34.345

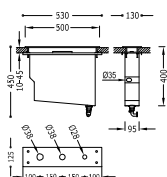

**Kit depósito para bañeras de repisa**

Fácil montaje superior. Sin registros (para ref.: 006.161.06, 006.161.04, 006.161.05, 006.161.03, 205.161.03, 205.161.01).

Cr 200.245.01

Ref.: |

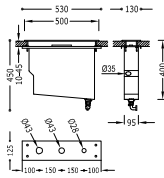

**Kit depósito para bañeras de repisa**

Fácil montaje superior. Sin registros (para ref.: 081.150.01).

Cr | 1.89.245 |

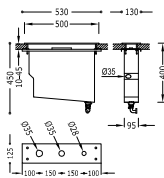

**Kit depósito para bañeras de repisa**

Fácil montaje superior. Sin registros (para ref.: 1.42.145.02).

Cr | 1.34.245 |

**Válvula bañera con toma drenaje**

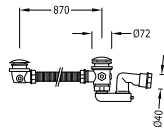

Cr | 1.34.445 |



# PROGRAMA DE DUCHAS

## Rociadores



Rociadores

296



Duchas de pared

300



Duchas de techo

298

## Barras de ducha



Barras deslizantes

306



Kits de ducha de gran formato

316



Kits de ducha

311

## Duchas



Duchas

325



Flexos

333



Brazos de ducha

329



Soportes con toma pared

335



Jets

331

# VENTAJAS EN LA DUCHA

## Rociadores



### Rociador enrasado

Diseño extraplano sin perder todas las características de eficiencia de una ducha.



### Brazos con rótula

Rótula giratoria incorporada en todos los rociadores para disfrutar de total libertad de movimiento.

## Barras de ducha



### Sujeción regulable

Sistema de sujeción a pared deslizante para aprovechar posibles orificios existentes.



### Toma de agua

Inteligente solución de cómo llevar el agua sin la necesidad de más obras.



### Soporte orientable

Y con altura regulable deslizándose por la barra.



### Inversor integrado

Invierte la salida de agua entre la ducha de mano, el rociador o ambas simultáneamente.



## Duchas de mano



### Sistema anticalcáreo

Boquillas de silicona que evitan la incrustación de cal. Fácil de limpiar con el dedo.

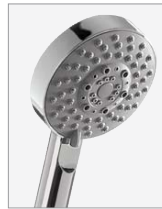

### Distintas funciones

De una a cinco funciones: chorros masajeantes, estimulantes, efecto lluvia...

## Flexos

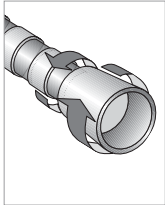

### Giratorio antitorsión

Sistema antitorsión que permite un giro de 360° de la ducha evitando la torcedura del flexo.



### Acabado SATIN

La cubierta exterior es de material sintético con apariencia cromada. Higiénico y fácil de limpiar.



### Toma universal

La toma estándar 1/2" se adapta a todos los tipos de duchas, soportes y grifería.



### Flexo doble engatillado

Este flexo altamente resistente evita, en caso de rotura, la aparición de aristas cortantes.

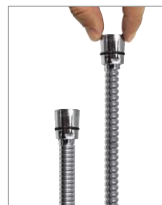

### Flexo Inox extensible

Material metálico cromado de alta calidad con la capacidad de extenderse de 1,70 a 2,00 m.

ROCIADORES

Ref.:

Rociador ducha a techo  
Anticalcárea. 330x330 mm.

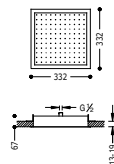
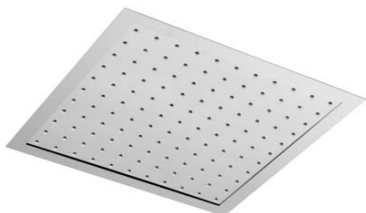

U/m:	11	330
Cr	1.34.714	330



Rociador ducha INOX a pared  
Anticalcárea. 210x550 mm.

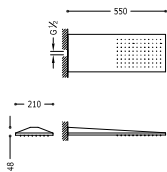

U/m:	12.5	210
Cr	299.903.02	550



Rociador ducha INOX a pared  
Anticalcárea. 160x550 mm.

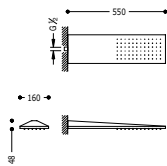

U/m:	12.5	160
Cr	299.903.03	550



**Rociador ducha a techo**  
Anticalcárea. Ø 330 mm.

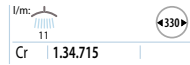
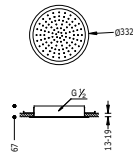

**Rociador ducha INOX a pared**  
Anticalcárea. 210x550 mm.

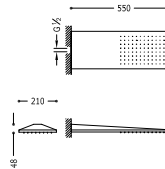

**Rociador ducha INOX a pared**  
Anticalcárea. 160x550 mm.

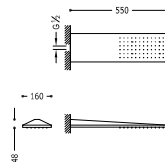

Brazo de ducha a techo con rociador anticalcárea

		 U/mc 11 Cr 1.34.121	
		 U/mc 11 Cr 1.34.831	
+			 U/mc 12 Cr 299.432.02
		 U/mc 14 Cr 299.432.03	
		 U/mc 16 Cr 299.432.05	



l/m:  11 ◀250▶  
Cr | 1.34.221 |



l/m:  11 ◀300▶  
Cr | 1.34.331 |

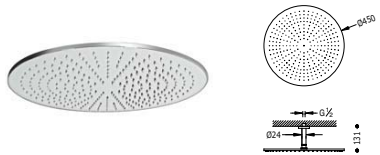



l/m:  15 ◀450▶  
Cr | 299.432.04 |



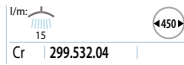
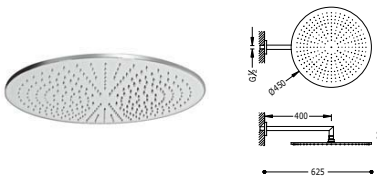
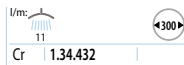
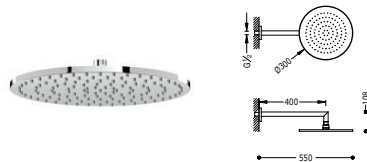
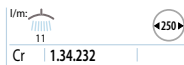
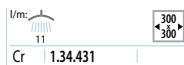
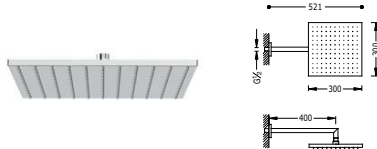
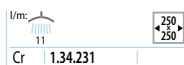

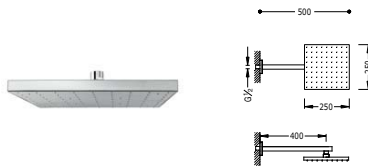
Brazo de ducha a pared con rociador anticálcea





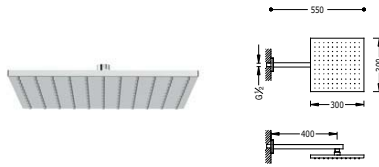

I/m:  11   
Cr | 1.34.233 |

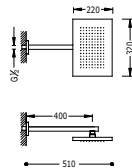

I/m:  11   
Cr | 1.34.433 |



I/m:  12   
Cr | 299.532.02 |

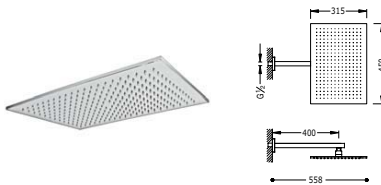

I/m:  14   
Cr | 299.532.03 |

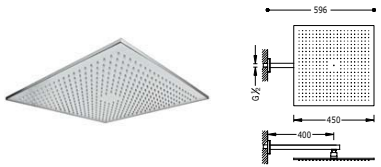

I/m:  16   
Cr | 299.532.05 |

**Rociador ducha anticálcarea**  
todo cromo 200x200 mm.

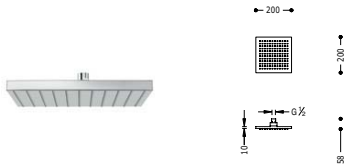

**Rociador ducha anticálcarea FULL**  
todo cromo 250x250 mm.



**Rociador ducha anticálcarea CUB-300**  
Latón 300x300 mm.

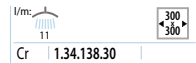
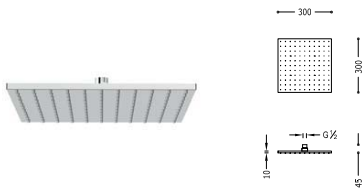

**Rociador ducha anticálcarea LOFT-220**  
todo cromo 220x220 mm.

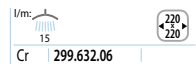

**Rociador ducha anticálcarea**  
320x220 mm.

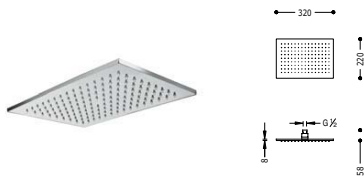

**Rociador ducha anticálcarea**  
450x315 mm.

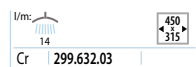
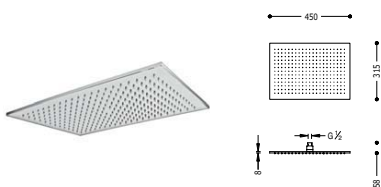



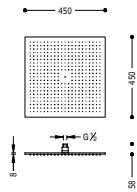

**Rociador ducha anticalcárea**  
450x450 mm.

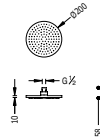
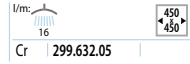

**Rociador ducha anticalcárea**  
todo cromo Ø 200 mm.

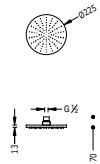

**Rociador ducha anticalcárea LEX-225**  
todo cromo Ø 225 mm.

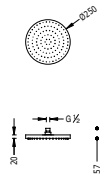

**Rociador ducha anticalcárea FULL**  
todo cromo Ø 250 mm.

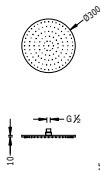
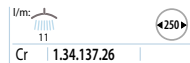

**Rociador ducha anticalcárea MAX-300**  
Latón Ø 300 mm.

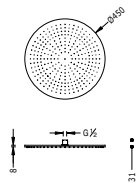
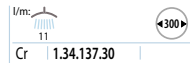

**Rociador ducha anticalcárea**  
Ø 450 mm.



**Rociador ducha anticalcárea CLASIC/RETRO**  
 Ø 310 mm.



I/m:		11	
Cr	299.337.03		
Lv	299.337.03.LV		



**Brazo pared**  
 para rociador ducha long. 300 mm.



Cr 1.34.621.01



**Brazo pared**  
 para rociador ducha long. 400 mm.



Cr 1.34.621.04

**Brazo pared**  
 para rociador ducha



Cr 1.34.139.40

**Brazo pared**  
 para rociador ducha



Cr 1.61.187.40

**Brazo pared**  
 para rociador ducha



Cr 299.639.02

**Brazo pared**  
para rociador ducha



Cr | 062.432.01 |

**Brazo techo**  
para rociador ducha

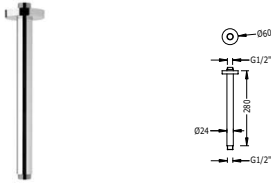

Cr | 1.34.621.02 |

**Brazo techo**  
para rociador ducha



Cr | 1.34.521.02 |

**Brazo techo**  
para rociador ducha

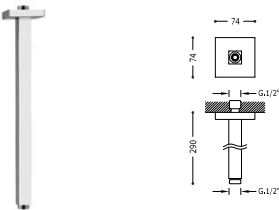

Cr | 1.34.622.02 |

**Brazo techo**  
para rociador ducha

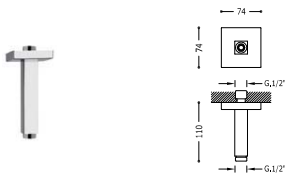

Cr | 1.34.522.02 |



Ref.:

**Barra deslizante PROJECT**

Latón long. 659 mm.

Latón long. 909 mm.

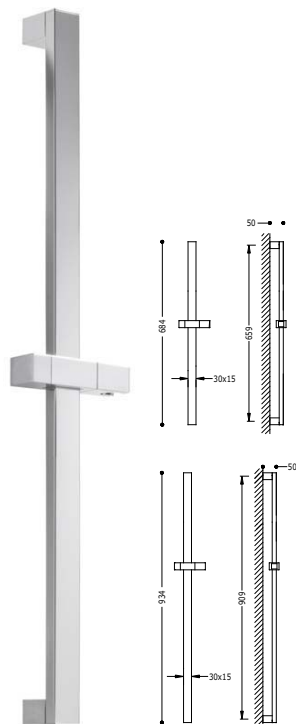

	(659 mm.)	
Cr	<b>1.34.516</b>	
	(909 mm.)	
Cr	<b>1.34.517</b>	

Cr = Cromo

**BARRAS DESLIZANTES**

Ref.: |

**Barra deslizante CUADRO-SLIM**

Latón long. 663 mm.  
Latón long. 900 mm.

**Barra deslizante CUADRO**

Latón long. 842 mm.

**Barra deslizante LOFT**

Ø 14 mm. long. 800 mm.



	(663 mm.)
Cr	1.07.922
	(900 mm.)
Cr	1.34.520

	(842 mm.)
Cr	1.07.935

	(800 mm.)
Cr	034.637.01

**Barra deslizante MINIMAL**

Ø 19 mm, long. 550 mm.  
Ø 19 mm, long. 850 mm.

**Barra deslizante MAX-MINI**

Ø 20,6 mm, long. 624 mm.

**Barra deslizante**

Ø 20,6 mm, long. 762 mm.



	(550 mm.)
Cr	1.34.618
	(850 mm.)
Cr	1.34.619

	(624 mm.)
Cr	034.637.02

	(762 mm.)
Cr	034.637.08



**Barra deslizante PRACTIC-MAX**

Ø 20,6 mm. long. 516 mm. con 2 soportes de fijación ajustable.  
Ø 20,6 mm. long. 816 mm. con 2 soportes de fijación ajustable.

**Barra deslizante LUXUS**

Ø 25 mm. long. 578 mm.

**Barra deslizante ECO**

Ø 25 mm. long. 614 mm.



	(516 mm.)	
Cr	1.61.835	
	(816 mm.)	
Cr	1.61.838	

	(578 mm.)	
Cr	1.34.835	

	(614 mm.)	
Cr	1.43.835	

**Barra deslizante ARC**  
long. 669 mm.



**Barra deslizante RETRO**  
Ø 18 mm. long. 548 mm.



**Barra deslizante FASHION**  
Ø 20,6 mm. long. 673 mm.



	(669 mm.)	
Cr	<b>1.34.737</b>	

	(548 mm.)	
Cr	<b>1.34.732</b>	
Lv	<b>5.34.732.01</b>	
Ac	<b>5.34.732.03</b>	

	(673 mm.)	
Cr	<b>034.637.06</b>	



**KITS DE DUCHA**

Ref.:

**Kit anticalcárea PROJECT-SLIM**

Latón long. 659 mm. Flexo SATIN  
Latón long. 909 mm. Flexo SATIN

**Kit anticalcárea PROJECT**

Latón long. 659 mm. Flexo SATIN  
Latón long. 909 mm. Flexo SATIN

**Kit anticalcárea CUADRO-SLIM**

Latón long. 663 mm. Flexo SATIN  
Latón long. 900 mm. Flexo SATIN

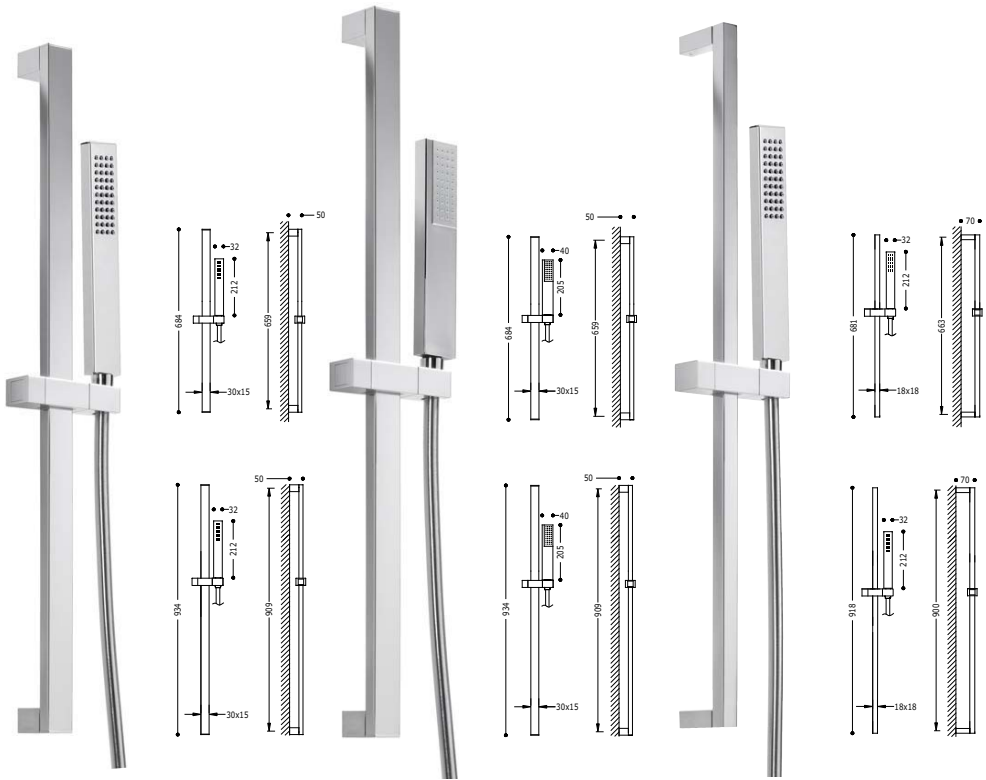

l/m: $\varnothing$	9,5
	(659 mm.)
Cr	034.526.02
	(909 mm.)
Cr	034.527.02

l/m: $\varnothing$	16
	(659 mm.)
Cr	1.34.526
	(909 mm.)
Cr	1.34.527

l/m: $\varnothing$	9,5
	(663 mm.)
Cr	034.336.03
	(900 mm.)
Cr	034.336.04

**Kit anticalcárea CUADRO**  
Latón long. 842 mm. Flexo SATIN

**Kit anticalcárea CUADRO-MINI**  
Latón long. 663 mm. Flexo SATIN  
Latón long. 900 mm. Flexo SATIN

**Kit anticalcárea LOFT**  
Ø14 mm. long. 800 mm. Flexo SATIN

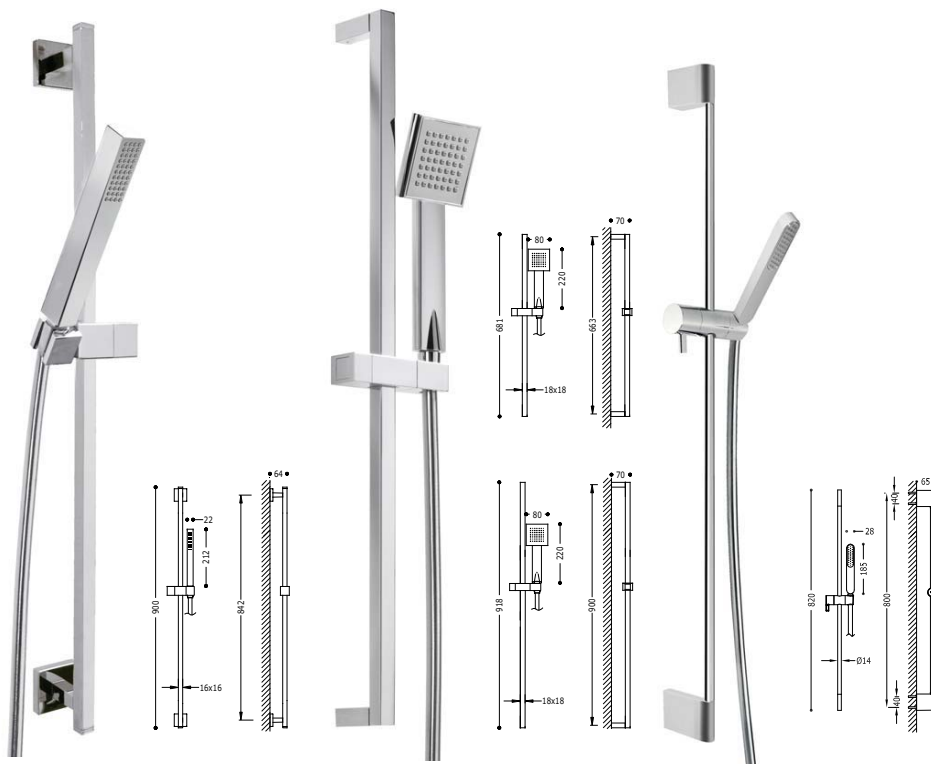

I/m:	9.5	(842 mm.)
Cr	1.07.934	
	6.07.934	
	4.07.934	

I/m:	15	(663 mm.)
Cr	1.34.512	
		(900 mm.)
Cr	1.34.522	

I/m:	13	(800 mm.)
Cr	034.336.01	

**Kit anticálcarea FASHION**

Ø 20,6 mm. long. 673 mm. Flexo SATIN

**Kit de ducha**

Ø 19 mm. long. 850 mm. Flexo SATIN

**Kit de ducha**

Ø 19 mm. long. 850 mm. Flexo SATIN

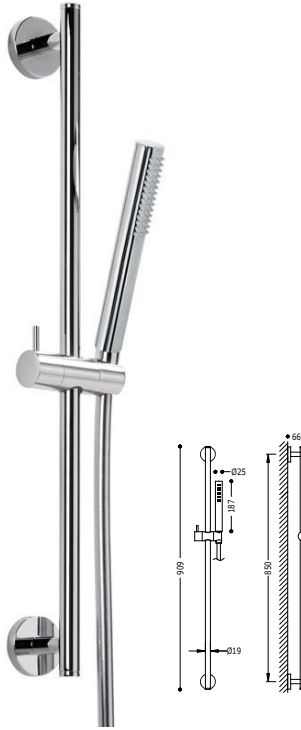

l/m: 10  
(673 mm.)  
Cr **034.637.07**



l/m: 9,5  
(850 mm.)  
Cr **034.629.02**

l/m: 10  
(850 mm.)  
Cr **061.928.01**

**Kit de ducha MINIMAL**

Ø 19 mm. Long. 550 mm. Flexo SATIN.  
 Ø 19 mm. Long. 850 mm. Flexo SATIN.

**Kit anticalcárea AQUA PLUS**

Ø 20,6 mm. long. 516 mm. Flexo SATIN

**Kit masaje PLUS**

Ø 25 mm. long. 578 mm. Flexo SATIN

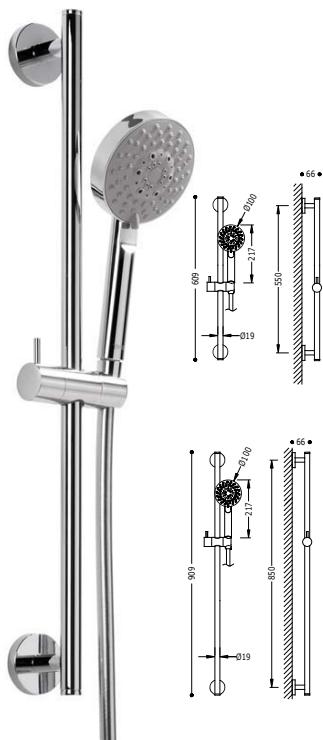

l/m:							◀100▶
	16	16,5	15,5	16	16	11	
	(550 mm.)						
Cr	1.34.628						
	(850 mm.)						
Cr	1.34.629						

l/m:		◀100▶
	10	
	(516 mm.)	
Cr	061.849.02	

l/m:					◀82▶
	11	8	6	6	
	(578 mm.)				
Cr	1.34.923				

**Kit masaje ECO**

Ø 25 mm. long. 614 mm. Flexo SATIN

**Kit de ducha**

Ø 20,6 mm. long. 575 mm. Flexo SATIN. Con toma pared  
Ø 20,6 mm. long. 966 mm. Flexo SATIN. Con toma pared

**Kit de ducha**

Ø 20,6 mm. long. 575 mm. Flexo SATIN. Con toma pared  
Ø 20,6 mm. long. 966 mm. Flexo SATIN. Con toma pared

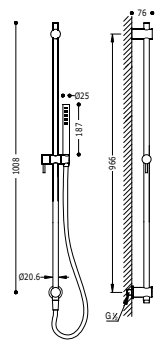
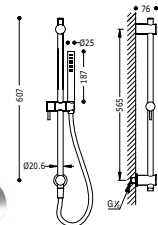
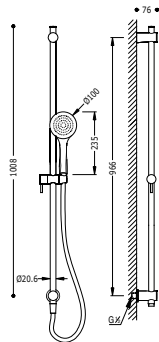
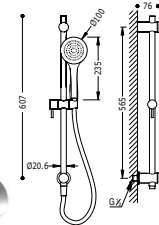
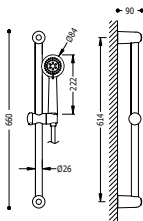

U/m:	15 7	◀ 80 ▶
Cr	1.43.836	

U/m:	10	◀ 110 ▶
Cr	061.931.03	
Cr	061.931.05	

U/m:	9,5	◀ 110 ▶
Cr	061.931.02	
Cr	061.931.04	

KITS DE DUCHA DE GRAN FORMATO

Ref.:

Conjunto ducha anticalcárea CUADRO

Ducha fija 250x250 mm. Flexo SATIN. Ducha móvil anticalcárea. Adaptable a grupo de ducha y baño-ducha

Kit ducha anticalcárea CUADRO

Ducha fija 250x250 mm. Ducha móvil anticalcárea y flexo SATIN. Con toma pared

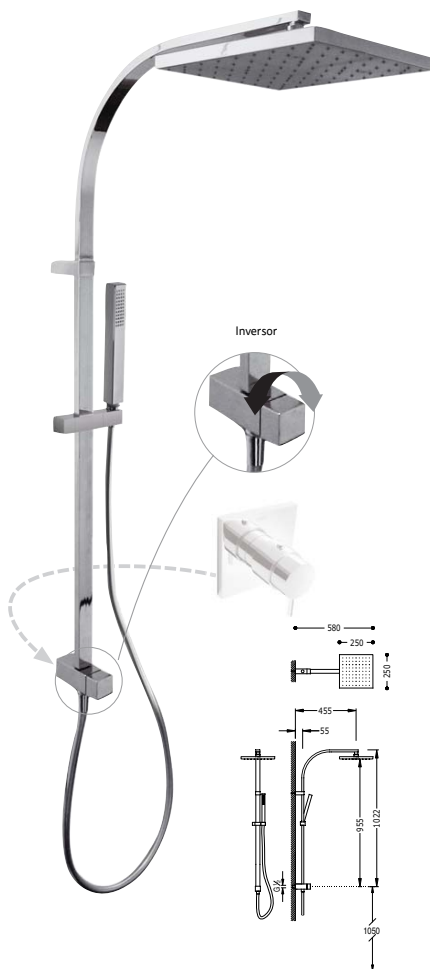
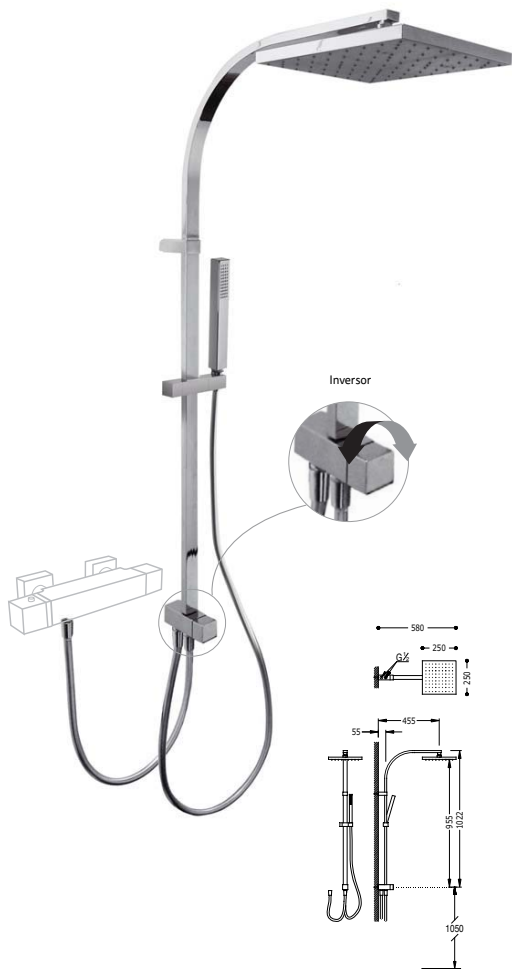

**Conjunto ducha anticálcarea CUADRO**

Ducha fija 250x250 mm. Flexo SATIN. Ducha móvil anticálcarea. Adaptable a grupo de ducha y baño-ducha

**Conjunto ducha anticálcarea RETRO**

Ducha fija Ø 310 mm. Ducha móvil anticálcarea. Adaptable a grupo de ducha y baño-ducha

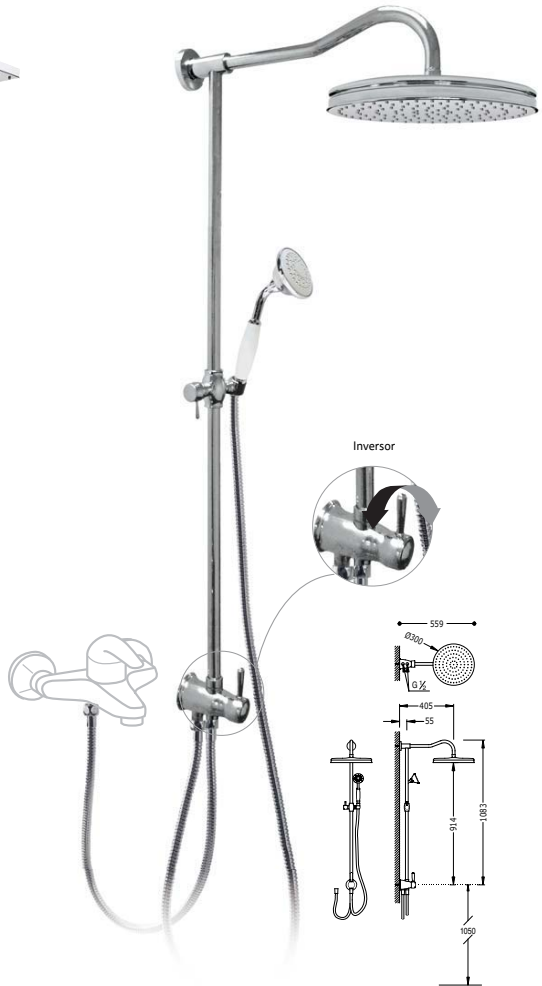
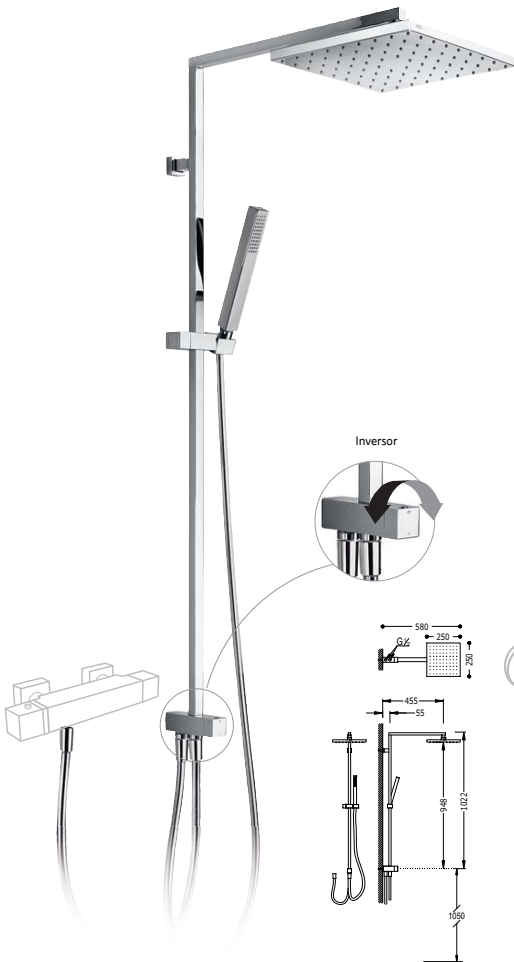

l/mc. 9.5  
Cr | 1.07.476

l/mc. 13  
Cr | 024.476.01

**Barra de ducha ECO-TERM**

Ducha fija Ø 225 mm. Flexo SATIN. Ducha móvil masaje Ø 100 mm. (5 funciones). Adaptable a grupo de ducha y baño-ducha.

**Barra de ducha ECO-TERM**

Ducha fija Ø 225 mm. Flexo SATIN. Ducha móvil masaje Ø 100 mm. (5 funciones). Con toma pared

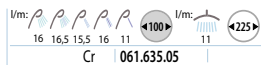



**Barra de ducha masaje**

Ducha fija Ø 250 mm. Flexo SATIN. Ducha móvil masaje Ø 100 mm. (5 funciones). Adaptable a grupo de ducha y baño-ducha.

**Barra de ducha masaje**

Ducha fija Ø 250 mm. Flexo SATIN. Ducha móvil masaje Ø 100 mm (5 funciones). Con toma pared

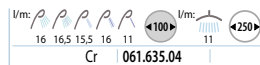

**Kit de ducha anticalcárea**

Barra deslizable sobre sus soportes de pared. Ducha fija Ø 250 mm. Ducha móvil masaje Ø 100 mm (5 posiciones). Flexo SATIN. Adaptable a grupo de ducha y baño-ducha.

**Kit de ducha anticalcárea**

Barra deslizable sobre sus soportes de pared. Ducha fija 250x250 mm. Ducha anticalcárea. Flexo SATIN. Adaptable a grupo de ducha y baño-ducha.

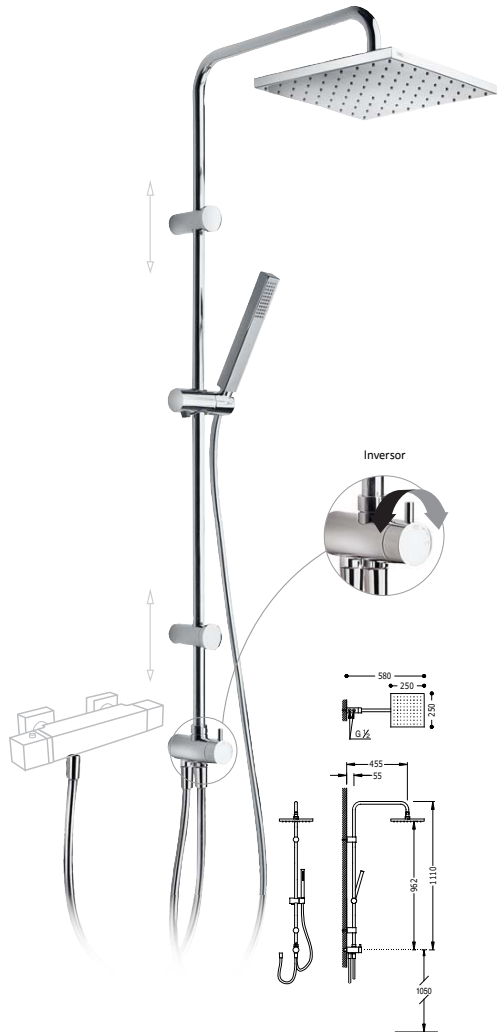
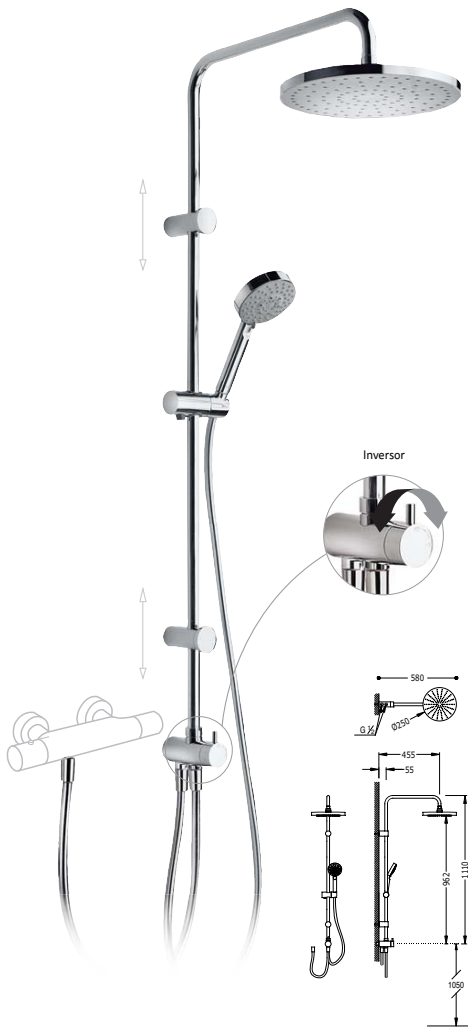

**Kit de ducha anticálcea**

Barra deslizable sobre sus soportes de pared. Ducha fija Ø 300 mm. Latón. Ducha móvil masaje Ø 100 mm (5 posiciones). Flexo SATIN. Adaptable a grupo de ducha y baño-ducha.

**Kit de ducha anticálcea**

Barra deslizable sobre sus soportes de pared. Ducha fija 300x300 mm. Latón. Ducha anticálcea. Flexo SATIN. Adaptable a grupo de ducha y baño-ducha.

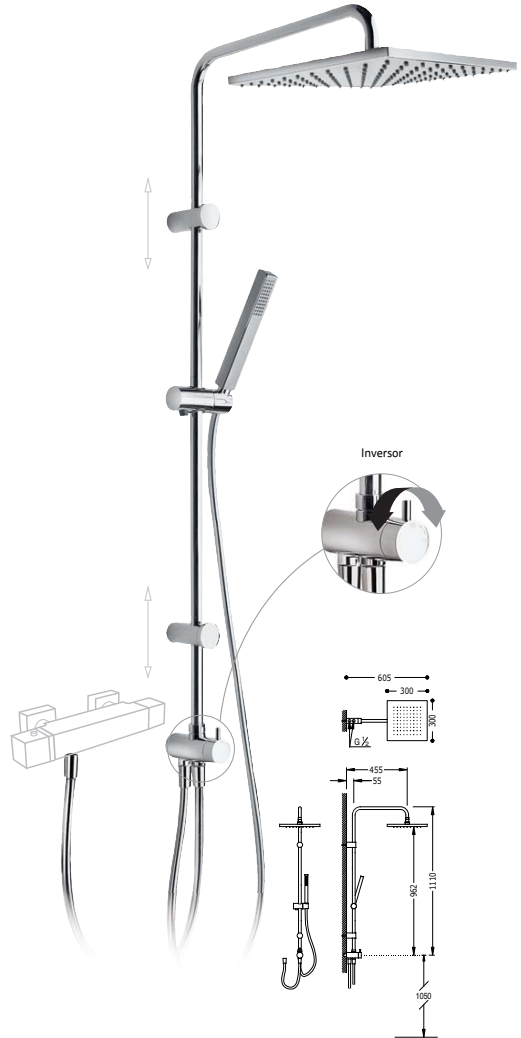
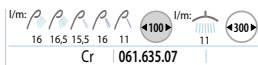
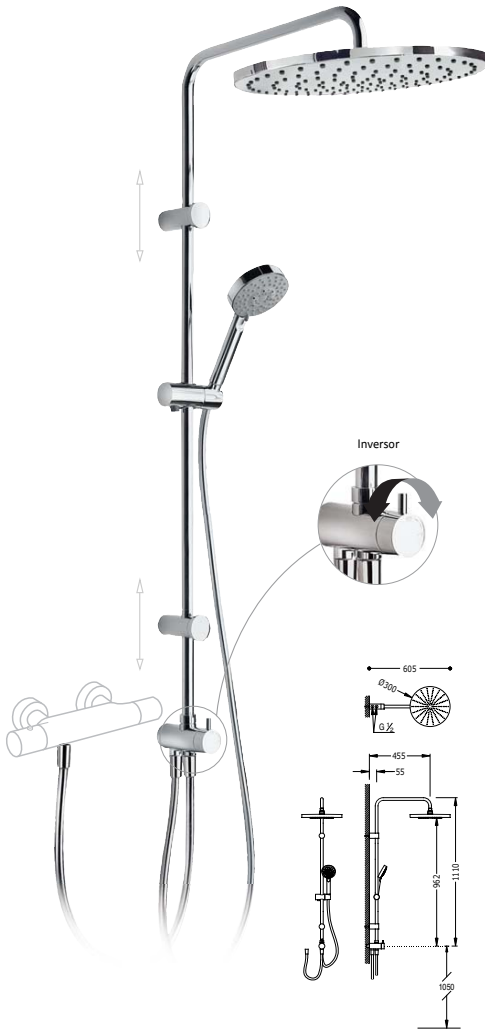

**Conjunto de ducha anticálarea**

Ducha fija 200x200 mm. Ducha móvil anticálarea. Flexo doble engatillado. Adaptable a grupo de ducha y baño-ducha



**Kit de ducha anticalcárea**

Ducha fija Ø 250 mm. Flexo SATIN. Ducha móvil masaje Ø 100 mm (5 funciones). Telescópico. Con distribuidor

**Kit de ducha anticalcárea**

Ducha fija Ø 225 mm. Flexo SATIN. Ducha móvil anticalcárea Ø 100 mm. Telescópico. Con distribuidor

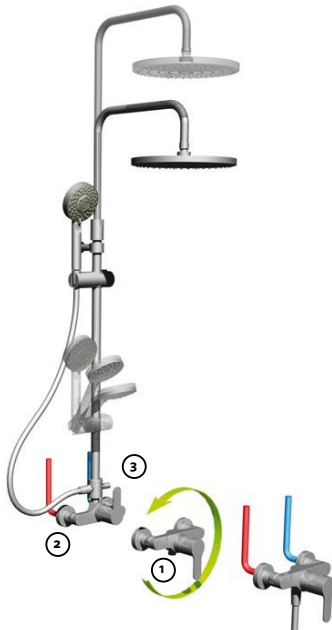
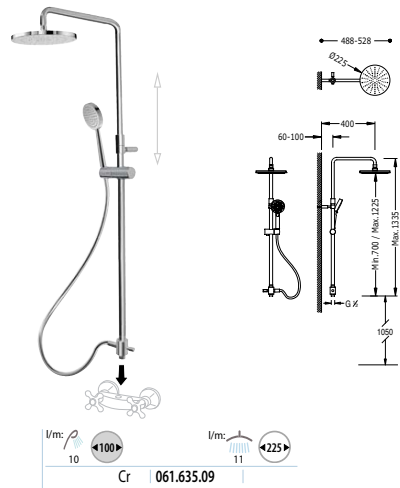
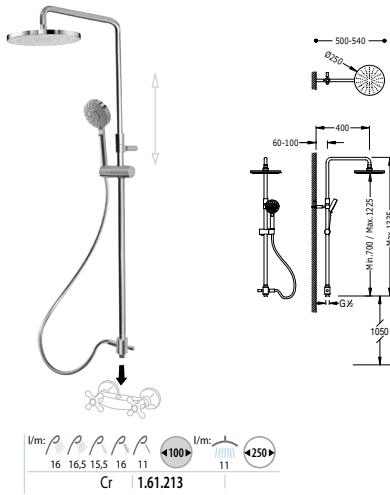

**Instalación**





DUCHAS

Ref.:

Ducha anticalcárea CLASS

Ducha PROJECT

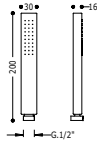

l/m: 12  
Cr 299.631.08

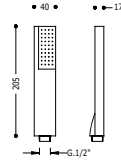

l/m: 16  
Cr 1.34.611

Ducha anticalcárea LOFT

Ducha TUB  
Ø 24 mm. Latón

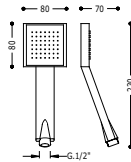

l/m: 15  
Cr 1.34.612

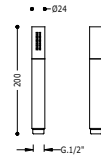

l/m: 12  
Cr 91.34.123.80

Ducha tubo WC

Ø 24 mm. Latón. Con racord limitador 5 l/m. ANTIGOTEÓ (para ref.: 34.122, 34.123, 81.122, 81.123, 81.222, 81.223, 62.122, 62.123)

Ducha con cierre

(para ref.: 81.113, 61.113, 203.113.01)

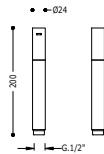

l/m: 5  
Cr 91.34.123.90

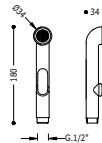

l/m: 8  
Cr 299.113.51

**Ducha masaje**  
5 tipos de chorro

**Ducha anticálcarea**

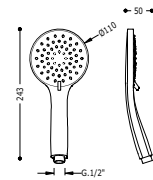

l/m:									110
	10	10	8.5	9.5	8.5				
Cr	299.631.06								

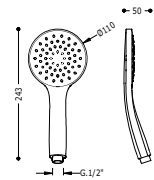

l/m:									110
	10								
Cr	299.631.05								

**Ducha LEX-100**  
5 tipos de chorro

**Ducha anticálcarea**

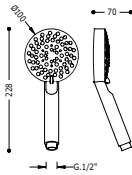

l/m:									100
	16	16.5	15.5	16	11				
Cr	1.34.748								

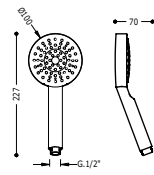

l/m:									100
	9.5								
Cr	299.748.02								

**Ducha masaje PAUSA**

3 tipos de chorro con reducción de caudal mínimo al pulsar opción STOP-TRES evitando así de nuevo la graduación.

**Ducha anticálcarea PAUSA**

2 tipos de chorro con reducción de caudal mínimo al pulsar opción STOP-TRES evitando así de nuevo la graduación.

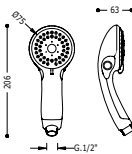

l/m:									75
	14	-90%							
Cr	1.34.530								

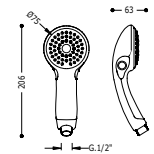

l/m:									75
	14	-90%							
Cr	1.34.531								





Ducha anticalcárea

Ducha ECO-ANTICAL

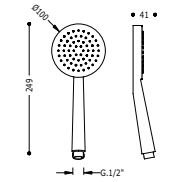

I/m:		10	
Cr		299.631.03	
I/m:		6	
Cr		299.631.07	



I/m:		7.5	
Cr		91.34.725	

Ducha masaje AQUA PLUS  
2 tipos de chorro

Ducha anticalcárea AQUA

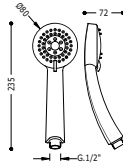

I/m:		15	7	
Cr		1.34.627		

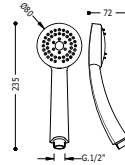

I/m:		15.5	
Cr		1.34.617	

Ducha masaje PLUS  
3 tipos de chorro

Ducha anticalcárea PLUS

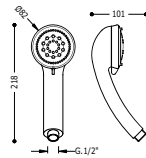

I/m:		11	8	6	
Cr		1.34.823			



I/m:		11	
Cr		1.34.821	

Ducha anticálcarea CONFORT

Indica la temperatura del agua con el color de la luz (sin pilas)

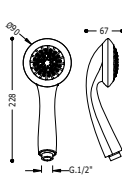

U/m: 9  
Cr 1.34.802



0° - 32°



32° - 42°



42° - 65°



Ducha anticálcarea RETRO

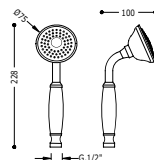

U/m: 13  
Cr 1.24.824  
Lv 5.24.824.01  
Ac 5.24.824.03



Ducha anticálcarea CLASIC-TRES

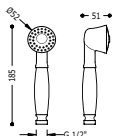

U/m: 15  
Cr 91.34.824  
Lv 91.34.824.05.1  
Ac 91.34.824.05.3



Ducha ORDAL antigua

Codo antiguo

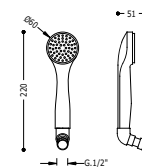

U/m: 26,5  
■ 91.34.825.10



Ducha lavavajillas

(para ref.: 41.443, 50.443, 70.443.38, 73.443.02)



U/m: 12 12  
Cr 91.34.880



Ducha lavavajillas

(para ref.: 30.444, 41.444, 44.444, 72.443, 73.443, 73.444, 039.444.01, 069.444.01)

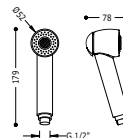

U/m: 12 12  
Cr 91.34.849



Ducha monomando peluquería

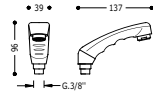

I/m: 11  
**91.34.450**

**BRAZOS DUCHA**

**Brazo ducha ECO masaje PLUS**  
con regulador de caudal 3 posiciones

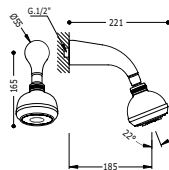

I/m: 17 12 6  
**Cr 1.34.818**

**Piña brazo ducha PLUS**

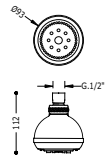

I/m: 17 12 6  
**Cr 91.34.818.10**



Brazo ducha ECO

Piña brazo ducha ECO

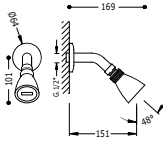

U/m: 37  
Cr | 1.34.738 | 54 ▶

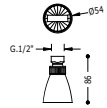

U/m: 37  
Cr | 91.34.738.10 | 54 ▶

Brazo ducha ORDAL

Piña brazo ducha ORDAL

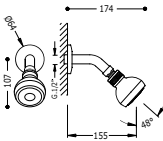

U/m: 22  
Cr | 1.34.808 | 70 ▶

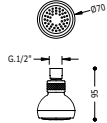

U/m: 22  
Cr | 91.34.808.10 | 70 ▶

Codo pared ECO

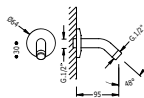

Cr | 1.34.738.50 |

JETS

Ref.:

**Jet empotrado de hidromasaje**

con 1 tipo de chorro orientable. Incluye un sistema antical, válvula antirretorno y limitador de caudal: 5 l/m. Ø 130 mm.

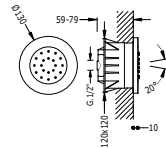

l/m: 5  
Cr 91.61.515

**Jet empotrado de hidromasaje**

con 1 tipo de chorro orientable. Incluye un sistema antical, válvula antirretorno y limitador de caudal: 5 l/m. 125x125 mm.

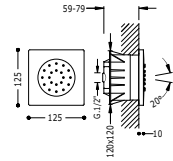
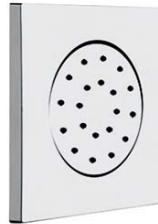

l/m: 5.25  
Cr 91.07.515

**Ducha lateral de hidromasaje**

con 1 tipo de chorro orientable. Incluye un sistema antical, válvula antirretorno y limitador de caudal: 5 l/m. Material Latón.

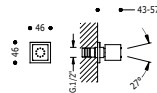

l/m: 5  
Cr 91.34.515

**Ducha lateral de hidromasaje**

con 1 tipo de chorro orientable. Incluye un sistema antical, válvula antirretorno y limitador de caudal: 5 l/m. Material Latón.

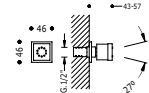

l/m: 5  
Cr 299.515.01

**Ducha lateral de hidromasaje**

con 1 tipo de chorro orientable. Incluye un sistema antical, válvula antirretorno y limitador de caudal: 5 l/m. Material Latón.

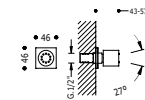

l/m: 5  
Cr 299.515.03

**Ducha lateral de hidromasaje**

con 1 tipo de chorro orientable. Incluye un sistema antical, válvula antirretorno y limitador de caudal: 5 l/m. Material Latón.

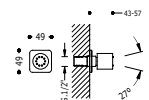

l/m: 5  
Cr 299.515.02

**Ducha lateral de hidromasaje**

con 1 tipo de chorro orientable. Incluye un sistema anticaida, válvula antiretorno y limitador de caudal: 5 l/m. Material Latón.

**Ducha lateral de hidromasaje**

2 funciones 6 l/m. y 4,5 l/m.

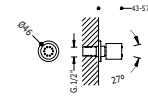

l/m: 5  
Cr 91.34.415

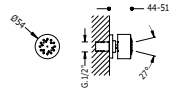

l/m: 6 4.5  
Cr 91.34.915

**Ducha lateral de hidromasaje**

1 función 4 l/m.

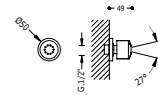

l/m: 4  
Cr 91.34.615

**FLEXOS**

Ref.:

**Flexo SATIN**

Ø 14,5 mm. Giratorio antitorción

**Flexo INOX EXTENSIBLE de 1,70 m.**

Ø 14 mm.



R1/2" R1/2"

**DUCHA**

	(750 mm.)	
St	91.34.609.10	
	(1.200 mm.)	
St	91.34.609.12	
	(1.500 mm.)	
St	91.34.609.15	
	(1.700 mm.)	
St	91.34.609	
	(2.000 mm.)	
St	91.34.609.20	



R1/2"

R1/2"

**DUCHA**

Inox | 91.34.630

**Flexo doble engatillado de 1,70 m.**

tuerca cónica con junta tórica y arandela prisionera en racor. Garantía diez años

**Flexo de 1,70 m.**



R1/2" R1/2"

**DUCHA**

Cr	91.34.828	
EXTENSIBLE Inox	91.34.830.80	



R1/2"

**DUCHA**

Lv	91.34.830.05.1	
Co	91.34.830.05.2	
Ac	91.34.830.05.3	

**Flexo doble engatillado de 1,25 m.**

Ø 12 mm. (para ref.: 30.444, 41.443, 41.444, 44.444, 50.443, 52.444, 54.444, 70.443, 72.443, 73.443, 73.444, 39.444, 69.444)

**Flexo de 1,70 m.**

Ø 12 mm. (para ref.: 30.430, 30.432, 30.433, 14.444, 43.444, 87.444, 130.460, 62.438, 30.452, 81.438)



M15x1 R1/2"

**COCINA**

Cr	91.34.867	
----	-----------	--



M15x1 Ø18x2,5

**COCINA**

Cr | 91.34.712

**Flexo doble engatillado de 1,70 m.**

para bañera de repisa (para ref.: 06.161, 07.161, 14.150, 17.145, 39.145, 41.145, 43.145, 43.147, 44.145, 61.150, 61.161, 61.181, 62.150, 62.161, 63.145, 63.181, 69.145, 72.145, 73.145, 74.145, 85.145, 87.150, 87.161, 87.181, 89.150, 70.145, 81.150, 81.161, 89.161, 200.161, 200.162, 202.161, 202.661, 203.161, 205.161, 261.150, 262.150)



**BAÑERA DE REPISA**

Cr 91.34.881

**Flexo metálico de 1,50 m.**

(para ref.: 145 CLASICTRES, MONOCLASIC 1900, RETROTRES)



**BAÑERA DE REPISA**

Cr 91.34.731  
Lv 91.34.731.05.1

**Flexo mod. peluquería de 1,30 m.**

3/8" macho 3/8" hembra (para ref.: 72.450)



**PELUQUERÍA**

91.34.887



**SOPORTES CON TOMA PARED**

Ref.: |

Soporte para ducha  
con toma pared

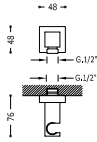

Cr 006.182.01  
Ac 006.182.01.AC

Soporte para ducha  
con toma pared

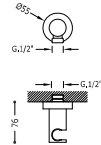

Cr 205.182.01

Soporte para ducha  
con toma pared

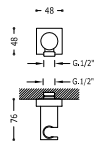

Cr 061.182.01

Soporte para ducha  
con toma pared

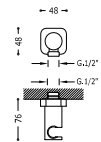

Cr 200.182.01

Soporte para ducha  
con toma pared

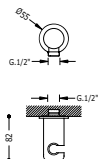

Cr 024.182.01

SOPORTES ORIENTABLES

Ref.:

Soporte orientable cuadrado  
Latón

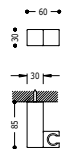

Cr	1.07.839	
Ac	5.07.839.03	

Soporte orientable redondo  
Latón

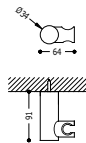

Cr	1.61.839	
Ac	5.61.839.03	

Soporte orientable

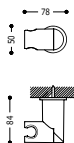

Cr	299.639.01	
Bl	91.34.839.00.4	

Soporte orientable  
Latón



Cr	91.34.832	
Lv	91.34.832.50.1	

Soporte fijo

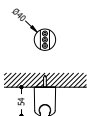

Cr	91.34.841	
----	-----------	--

Soporte fijo  
Con 2 posiciones para todos los flexos

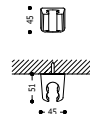

Cr	91.34.848	
----	-----------	--

**CODO ADAPTADOR**

Ref.: |

**Codo toma pared para flexo**  
Toma agua 1/2"

**Codo toma pared para flexo**  
Toma agua 1/2"



Cr 1.34.757

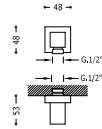

Cr 006.183.01  
Ac 006.183.01.AC

**Codo toma pared para flexo**  
Toma agua 1/2"

**Codo toma pared para flexo**  
Toma agua 1/2"

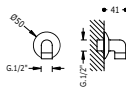

Cr 1.34.873

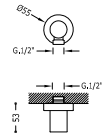

Cr 205.183.01

**Codo toma pared para flexo**  
Toma agua 1/2"

**Codo toma pared para flexo**  
Toma agua 1/2"

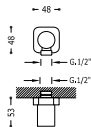

Cr 200.183.01

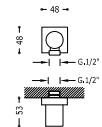

Cr 061.183.01

OTROS

Ref.:

**Jabonera LEX**

para barra deslizante Ø 20,5 mm. (para ref.: 1.81.821, 1.81.921)



Cr+Meta: 91.81.921.05

**Jabonera**

para barra deslizante Ø 18 mm. y Ø 24 mm. y para columnas AVAN-TRES



Cr 1.34.637  
Meta 5.34.637.05

**Jabonera CUB**

para barra deslizante Ø 18 mm. y Ø 24 mm.



Cr 91.87.195.10

**Jabonera DOBLE**

para barra deslizante Ø 18 mm. y Ø 24 mm.



Cr 91.61.195.10

**Jabonera LUXUS**

para barra deslizante Ø 25 mm.



Cr+Meta: 91.34.735

**ALARGADERAS**

Alargaderas

Alargaderas

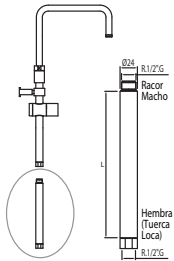

1  
(para ref: 90.312, 90.311, 90.310, 90.212, 90.211, 90.210, 90.213, 90.214, 87.355, 87.356, 024.164.04)

L= 300 mm.	Cr	<b>91.81.195.03</b>
L= 650 mm.	Cr	<b>1.81.195.02</b>

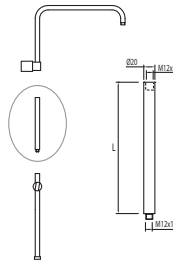

1  
(para ref: 012.995.01, 070.995.01, 081.192, 081.495.01, 083.192, 1.81.191, 1.81.386, 1.81.385\*)

\* posterior a mayo 2012

L= 300 mm.	Cr	<b>91.81.385.03</b>
L= 650 mm.	Cr	<b>1.81.385.06</b>

Alargaderas

Alargaderas

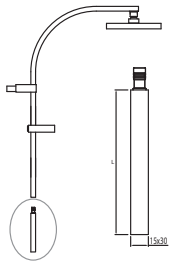

1  
(para ref: 1.07.395)

L= 300 mm.	Cr	<b>91.06.914.03</b>
L= 500 mm.	Cr	<b>1.06.914.05</b>

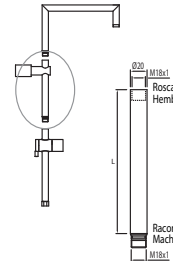

1  
(para ref: 90.481, 90.583, 90.281, 90.393)

L= 300 mm.	Cr	<b>91.34.463.03</b>
L= 650 mm.	Cr	<b>1.34.463.02</b>

Alargaderas

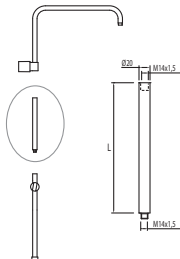

1  
(para ref: 90.385, 61.475, 1.81.385\*\*)

\*\* anterior a mayo 2012

L= 300 mm.	Cr	<b>91.34.195.03</b>
L= 650 mm.	Cr	<b>1.34.195.02</b>





## ACCESORIOS



Slim-Tres

344



Cuadro-Tres

345



Max-Tres / Class-Tres

346



Loft-Tres

348



Retro-Tres

350

[www.tresgriferia.com](http://www.tresgriferia.com)



**RECAMBIOS**  
DE LOS ARTÍCULOS EN  
[www.tresgriferia.com](http://www.tresgriferia.com)



## DECORACIÓN PARA BAÑOS SINGULARES



### Cromado y cerámica

Los accesorios combinan el cromado de alta resistencia con la cerámica blanca, dando sencillez y robustez al producto. Los accesorios están fabricados con materiales de calidad resistentes al desgaste.

---





































### Estética minimalista

Las diferentes líneas de accesorios comparten el minimalismo estético, ofreciendo adaptabilidad en cualquier espacio y facilidad en su limpieza.

---





	slim-tres	cuadro-tres	max-tres class-tres	loft-tres	retro-tres
					
					
					
					
					
					
					
	Diseño recto con superficies planas y sobrias. Combinable con accesorios Cuadro-tres.	Líneas rectas y cúbicas, puede combinar con accesorios Slim-tres.	Estética redonda o tubular fácilmente adaptable a cualquier espacio.	Superficies planas con cantos curvos, estilo moderno y singular.	El accesorio perfecto para baños rústicos o de aspecto antiguo.



SLIM-TRES

Ref.:

Toallero

Toallero



(450 mm.)

Cr 202.636.04



(600 mm.)

Cr 202.636.05

Portarrollos sin tapa

Escobillero de suelo cerámico



Cr 202.636.12

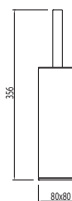

Cr 202.636.11

Dosificador jabón de encimera cerámico

Jabonera de encimera cerámica

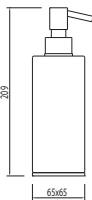

Cr 202.636.08

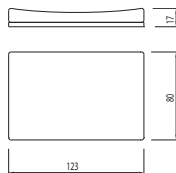

Cr 202.636.07

Vaso de sobremesa cerámico

Percha



Cr 202.636.09

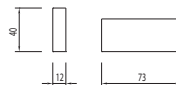

Cr 202.636.13

**CUADRO-TRES**

Ref.:

**Toallero**

**Percha**

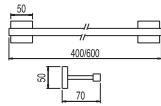

	(400 mm.)
Cr	<b>1.07.636.01</b>
	(600 mm.)
Cr	<b>1.07.636.03</b>

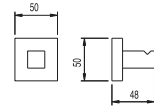

Cr	<b>1.07.636.20</b>
----	--------------------

**Repisa toallas**

**Escobillero de suelo cerámico**

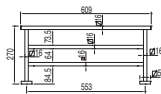

Cr	<b>1.07.636.08</b>
----	--------------------



Cr	<b>1.07.636.23</b>
----	--------------------

**Portarrollos sin tapa**

**Cubo papelera pedal**  
180x180x250 mm

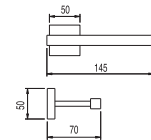

Cr	<b>1.07.636.06</b>
Ac	<b>5.07.636.06.53</b>

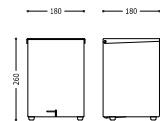

Inox	<b>1.07.636.27</b>
------	--------------------

**Escobilla**

(para ref.: 187.636.23, 1.87.636.24, 1.61.636.50.23, 1.61.636.50.23, 1.61.636.60.23, 1.61.636.50.24, 1.61.636.60.24, 1.61.636.23, 1.61.636.23.53, 1.61.636.24, 5.61.636.24.53, 1.24.636.04, 5.24.636.04.51, 1.07.636.23)

**Escobilla**

(para ref.: 200.636.10, 202.636.11, 200.636.11)

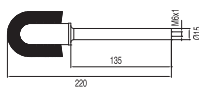

Bl	<b>91.87.636.90</b>
----	---------------------

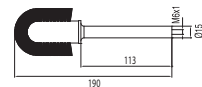

Bl	<b>91.200.636.90</b>
----	----------------------

MAX-TRES / CLASS-TRES

Ref.:

Toallero

Portarrollos sin tapa



	(480 mm.)
Cr	1.61.636.01
	(580 mm.)
Cr	1.61.636.02

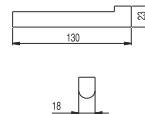

Cr	1.14.636.09
----	-------------

Toallero

Escobillero de suelo cerámico

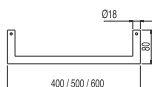

	(400 mm.)
Cr	1.14.636.01
	(500 mm.)
Cr	1.14.636.03
	(600 mm.)
Cr	1.14.636.02

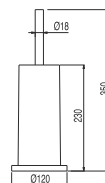

Cr	1.61.636.23
----	-------------

Toallero barra doble

Escobillero de pared cerámico

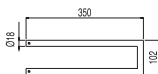

Cr	1.14.636.10
----	-------------

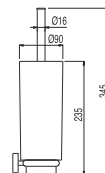

Cr	1.61.636.24
----	-------------

Portarrollos sin tapa

Escobillero de pared

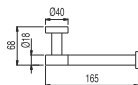

Cr	1.61.636.06
----	-------------

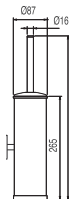

Cr	1.34.636.24
----	-------------

Dosificador jabón de pared cerámico

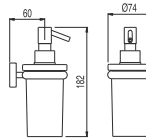

Cr 1.61.636.18

Portacepillos de pared cerámico

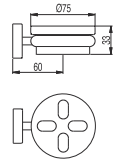

Cr 1.61.636.16  
Ac 5.61.636.16.53

Asidero bañera

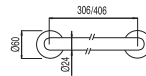

(306 mm.)  
Cr 1.34.184  
(406 mm.)  
Cr 1.34.184.40

Percha

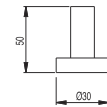

Cr 1.61.636.20

Asidero con jabonera

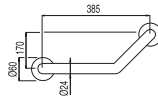

Cr 1.34.183

LOFT-TRES

Ref.:

Toallero

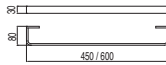

(450 mm.)

Cr 200.636.04

(600 mm.)

Cr 200.636.05

Repisa cristal transparente

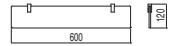

(600 mm.)

Cr 200.636.06

Portarrollos sin tapa

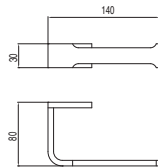

Cr 200.636.12

Repisa cristal transparente

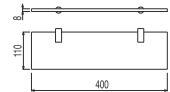

(400 mm.)

Cr 1.61.636.15

Escobillero de suelo cerámico

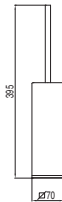

Cr 200.636.11

Dosificador jabón de encimera cerámico

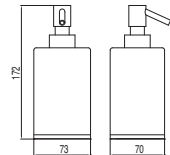

Cr 200.636.08

Escobillero de pared cerámico

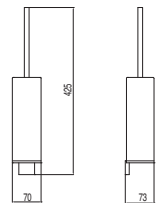

Cr 200.636.10

Jabonera de encimera cerámica

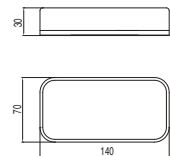

Cr 200.636.07

Vaso de sobremesa cerámico

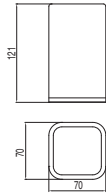

Cr 200.636.09

Percha

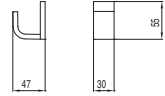

Cr 200.636.13



RETRO-TRES

Ref.:

Toallero

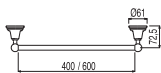

	(400 mm.)
Cr	1.24.636.01
Lv	5.24.636.01.51
	(600 mm.)
Cr	1.24.636.03
Lv	5.24.636.03.51

Portarrollos con tapa

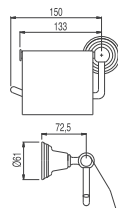

Cr	1.24.636.05
Lv	5.24.636.05.51

Toallero barra doble

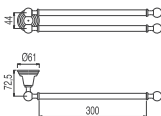

Cr	1.24.636.08
Lv	5.24.636.08.51

Toallero anilla abierto izquierda con jabonera

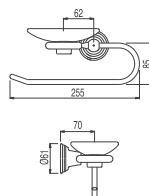

Cr	1.24.636.11
Lv	5.24.636.11.51

Toallero anilla cuadrado

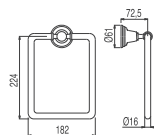

Cr	1.24.636.09
Lv	5.24.636.09.51

Repisa cristal transparente

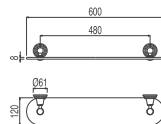

Cr	1.24.636.15
Lv	5.24.636.15.51

Portarrollos sin tapa

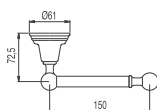

Cr	1.24.636.06
Lv	5.24.636.06.51

Portavasos de pared cerámico

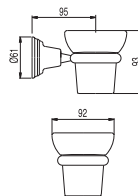

Cr	1.24.636.12
Lv	5.24.636.12.51



Portavasos-jabonera de encimera cerámico

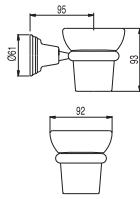

Cr	1.24.636.13
Lv	5.24.636.13.51

Escobillero de suelo cerámico

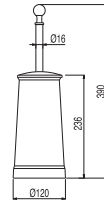

Cr	1.24.636.04
Lv	5.24.636.04.51

Jabonera de pared cerámico

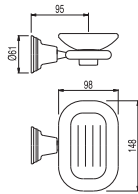

Cr	1.24.636.10
Lv	5.24.636.10.51

Percha

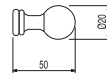

Cr	1.24.636.07
Lv	5.24.636.07.51





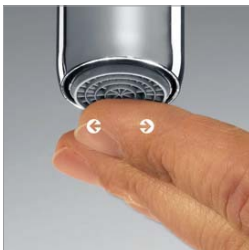

## COMPLEMENTOS



Válvulas

**354**



Desagües

**360**



Sifones

**362**



Florones

**365**



Caños

**365**



Llaves de paso

**368**



Otros

**369**



Limitadores de caudal

**373**



Aireadores

**374**



**RECAMBIOS**  
DE LOS ARTICULOS EN  
[www.tresgriferia.com](http://www.tresgriferia.com)

[www.tresgriferia.com](http://www.tresgriferia.com)



## Válvula SIMPLE-RAPID

Blocaje superior

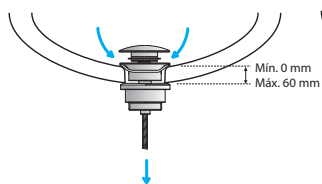
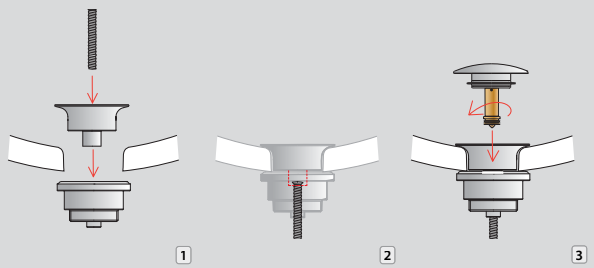

Referencias:  
1.61.840  
5.61.840.01  
5.61.840.03

LAVAMANOS SIN REBOSADERO

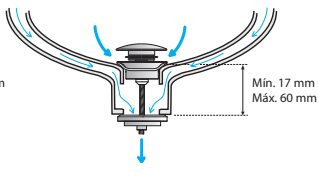

Referencias:  
1.62.840

LAVAMANOS CON REBOSADERO

## Válvula lavabo

Blocaje inferior

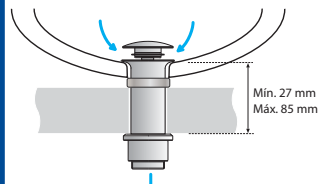

Referencias:  
1.34.940.10  
1.34.941.10  
1.34.942.10

ENCIMERA DE MADERA, ETC

### VÁLVULA SIMPLE-RAPID

Ref:

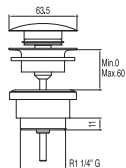

Válvula SIMPLE-RAPID  
Tapón Ø 63,5 mm CLICK-CLACK

Cr	1.61.840	
Lv	5.61.840.01	
Ac	5.61.840.03	

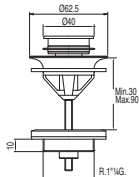

Válvula SIMPLE-RAPID  
CLICK-CLACK

Cr	1.62.840	
----	----------	--

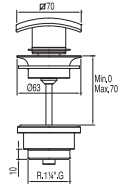

**Válvula SIMPLE-RAPID para serie CUADRO-TRES**  
Tapón cuadrado 70x70 mm CLICK-CLACK

Cr | 1.07.940 |

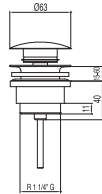

**Válvula lavabo SIMPLE-RAPID**  
Tapón  $\varnothing$  63 mm CLICK-CLACK

Cr | 1.34.540.10 |

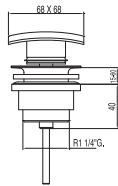

**Válvula lavabo SIMPLE-RAPID**  
Tapón cuadrado 68x68 mm CLICK-CLACK

Cr | 1.34.340.10 |

**VÁLVULA LAVABO SIN REBOSADERO**

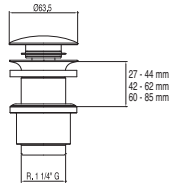

**Válvula ciega para lavabo de madera**  
Tapón  $\varnothing$  63,5 mm CLICK-CLACK

(27 - 44 mm.)

Cr | 1.34.940.10 |

(42 - 62 mm.)

Cr | 1.34.941.10 |

(60 - 85 mm.)

Cr | 1.34.942.10 |

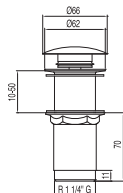

**Válvula lavabo sin rebosadero**  
Tapón  $\varnothing$  66 mm CLICK-CLACK

Cr | 1.34.540.60 |



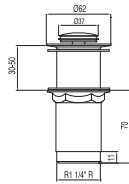

Válvula lavabo sin rebosadero  
Tapón Ø 37 mm CLICK-CLACK

Cr 1.34.540.50

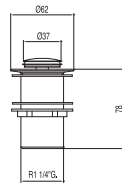

Válvula lavabo sin rebosadero  
Tapón Ø 37 mm CLICK-CLACK

Cr 1.34.540.70

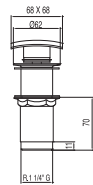

Válvula lavabo sin rebosadero  
Tapón cuadrado 68x68 mm CLICK-CLACK

Cr 1.34.341.20

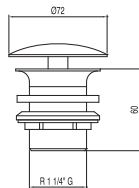

Válvula lavabo libre (desagüe siempre abierto)  
Tapón Ø 72 mm

Cr 1.34.240.10

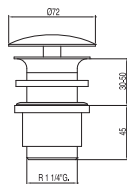

Válvula lavabo libre (desagüe siempre abierto)  
Tapón Ø 72 mm

Cr 1.34.240.30

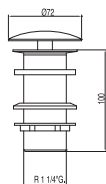

Válvula lavabo libre (desagüe siempre abierto)  
Tapón Ø 72 mm

Cr 1.34.240.30

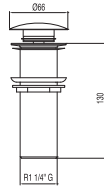

**Válvula lavabo sin rebosadero**  
Tapón Ø 66 mm CLICK-CLACK

Cr | 1.34.540.30 |

**VÁLVULA LAVABO CON REBOSADERO**

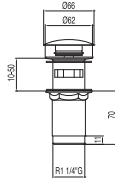

**Válvula lavabo con rebosadero**  
Tapón Ø 66 mm CLICK-CLACK

Cr | 1.34.541.60 |

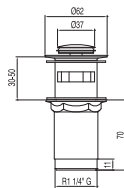

**Válvula lavabo con rebosadero**  
Tapón Ø 37 mm CLICK-CLACK

Cr | 1.34.541.10 |

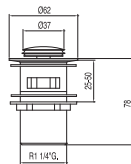

**Válvula lavabo con rebosadero**  
Tapón Ø 37 mm CLICK-CLACK

Cr | 1.34.541.90 |

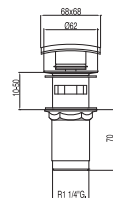

**Válvula lavabo con rebosadero**  
Tapón cuadrado 68x68 mm CLICK-CLACK

Cr | 1.34.340.20 |



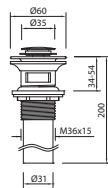

Válvula lavabo con rebosadero  
Tapón Ø 35 mm CLICK-CLACK

Cr 034.540.02

VÁLVULA LAVABO

Válvula desagüe automático

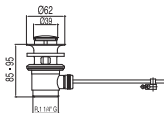

Cr 1.34.743.10

Válvula lavabo con rebosadero  
Tapón de latón con cadena



Cr 1.34.743.20

Válvula lavabo sin rebosadero  
Tapón de latón con cadena



Cr 1.34.743.30

Válvula desagüe lavabo sin rebosadero  
Tapón de latón con cadena

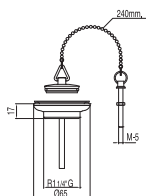

Cr 1.34.639.10



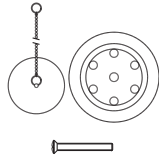

**Conjunto de accesorios para lavabo, bidé y fregadero Ø 70**  
Tapón de latón con cadena 42 cm

Lv | 91.34.746.0.5.1 |

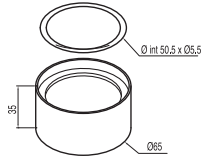

**Altura para válvulas de lavabo**  
Ø 65 x 35 mm.

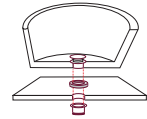

Cr | 91.61.103.48 |

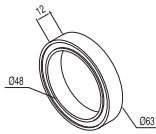

**Altura para válvulas de lavabo**  
Ø 63 x 12 mm.

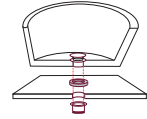

Cr | 1.34.633.10 |

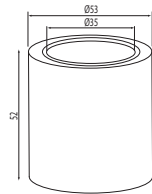

**Conjunto oculta-blocaje**  
para encimeras transparentes

Cr | 91.61.103.14 |

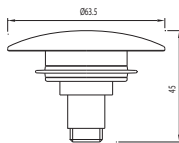

**Tapón CLICK-CLACK**  
Ø 63,5 mm (para ref: 1.61.840)

Cr | 91.61.840.60 |

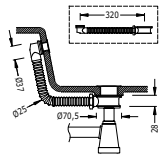

**Casquillo para desagües vistos con rebosadero**



Cr | 1.34.634.50 |



DESAGÜES

Ref.:

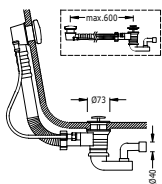

Desagüe automático bañera con rebosadero  
Tapón Ø 73 mm



Cr 1.34.846  
Lv 5.34.846.01

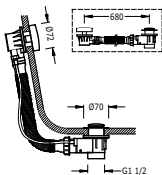

Desagüe automático bañera con rebosadero  
Tapón Ø 43 mm



Cr 1.34.534.10

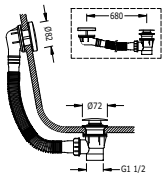

Desagüe bañera con rebosadero  
Tapón Ø 72 mm CLICK-CLACK

Cr 1.34.534.20

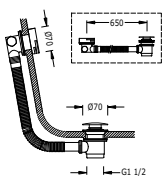

Desagüe bañera y válvula de llenado redonda CASCADA con rebosadero  
Tapón Ø 70 mm CLICK-CLACK



Cr 1.34.534.30

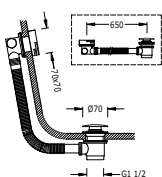

Desagüe bañera y válvula de llenado cuadrada CASCADA con rebosadero  
Tapón Ø 70 mm CLICK-CLACK

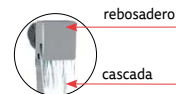

Cr 1.34.534.40

**Desagüe sifónico inspeccionable para plato de ducha**  
con sifón incorporado, desagüe 15 l/min, Ø 86 mm.

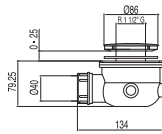

Cr | 1.34.552 |

**Desagüe sifónico inspeccionable para plato de ducha**  
con sifón incorporado, desagüe 31 l/min, Ø 120 mm.

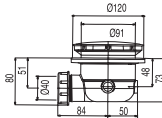

Cr | 1.04.840 |

**Desagüe sifónico inspeccionable para plato de ducha**  
con sifón incorporado, desagüe 62 l/min, Ø 118 mm.

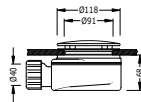

Cr | 1.04.841 |

**Válvula bañera**  
Tapón Ø 70 mm CLICK-CLACK

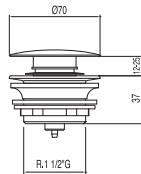

Cr | 1.34.740.10 |

**Desagüe para lavadero o similar**  
Ø 72 mm

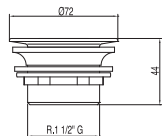

Cr | 1.34.740.20 |

**Tapón con suplemento embellecedor para desagüe automático**  
Ø 63 mm desagüe automático estándar

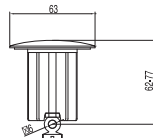

Cr | 91.34.840.26 |



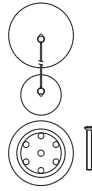

Conjunto de accesorios para bañera Ø70  
Cadena de 42 cm.

Lv 91.34.745.0.5.1

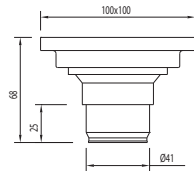

Sumidero  
Latón

Cr 034.740.07

SIFONES

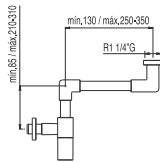

Sifón lavabo visto acodado telescópico

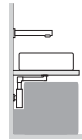

Cr 1.61.103.62

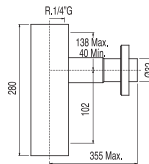

Sifón lavabo visto cuadrado telescópico con faldón

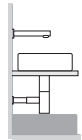

Cr 1.07.103.42

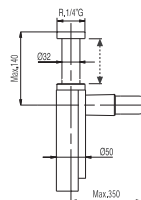

Sifón lavabo visto telescópico con faldón

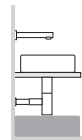

Cr 1.61.103.42  
Lv 5.61.103.4.5.1

Ref.: |

Sifón lavabo visto telescópico

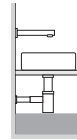
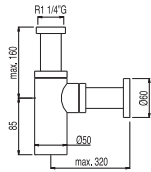

Cr | 1.61.103.72 |

Sifón lavabo visto telescópico

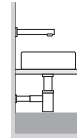
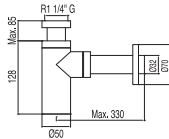

Cr | 1.34.634.10 |

Sifón lavabo visto cuadrado telescópico

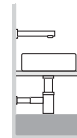
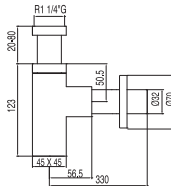

Cr | 1.34.634.20 |

Sifón botella lavabo auto-inspeccionable

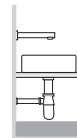
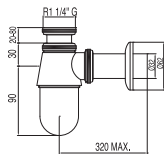

Cr | 1.34.634.30 |

Sifón botella bidé auto-inspeccionable

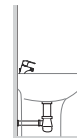
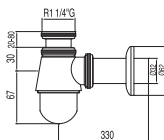

Cr | 1.34.634.40 |

Sifón curvo articulado para lavabo

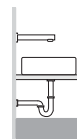
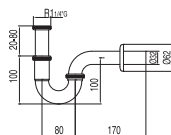

Cr | 1.34.638.10 |



Ref:

Sifón curvo articulado para lavabo. Con registro.

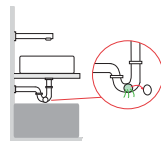
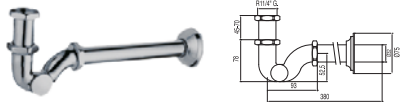

Cr 1.34.638.20

Tubo coarrugado desagüe flexible  
Latón long. 500 mm.

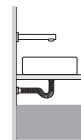
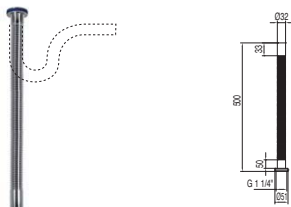

Cr 91.34.632.50

Sifón PVC bañera



Bl 1.34.634.60

Alargadera para sifón botella

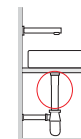
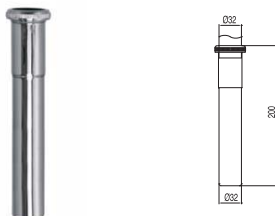

Cr 91.34.633.20

Tubo coarrugado flexible de latón para sifón botella  
300 mm

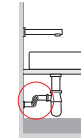

Cr 91.34.633.30

**FLORONES**

Ref.: |

**Florón metálico cuadrado**

exterior 65x65, interior Ø 32, altura 13 mm

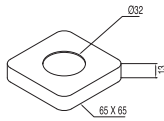

Cr | 91.34.744.10 |

**Florón metálico redondo**

exterior Ø 88, interior Ø 32, altura 45 mm

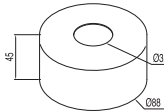

Cr | 91.34.744.30 |

**Florón metálico redondo**

exterior Ø 80, interior Ø 32, altura 14 mm

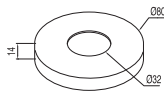

Cr | 91.34.744.20 |

**CAÑOS**

**Caño cascada**

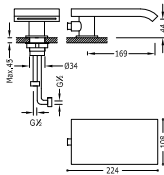

Cr | 1.62.161.50 |

**Caño cascada**

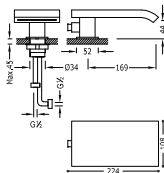

Cr | 1.87.182.50 |



Caño cascada para bañera-ducha

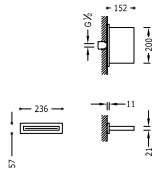

Cr 299.903.04

Caño cascada

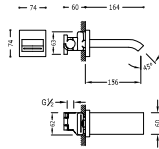

Cr 1.07.181



Caño pared

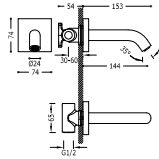

Cr 210.181.07



Caño pared

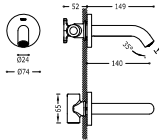

Cr 262.180.04



Caño cascada

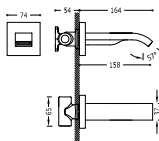

Cr 207.181.07

Caño pared

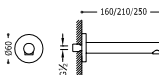

 (160 mm.)  
Cr 1.61.170.02

 (210 mm.)  
Cr 061.172.02

 (250 mm.)  
Cr 1.61.171.02



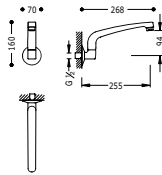

Caño fundido giratorio  
de 20,4 cm. (pared)

Cr | 1.34.301 |

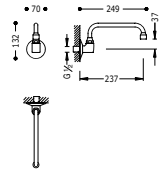

Caño tubo giratorio

(240 mm.)  
Cr | 1.34.302 |

(290 mm.)  
Cr | 1.34.303 |

Caño pared RETRO-TRES

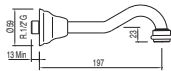

Cr | 1.24.173 |  
Lv | 5.24.173.01 |



LLAVES DE PASO

Ref.:

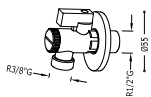

Llave de regulación con filtro  
R.1/2" - R.3/8"

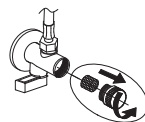

Cr 91.34.525

N

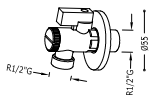

Llave de regulación con filtro  
R.1/2" - R.1/2"



Cr 299.525.05

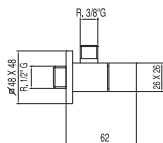

Llave de regulación cuadrada

Cr 1.34.742.20

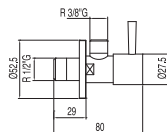

Llave de regulación

Cr 1.34.742.10

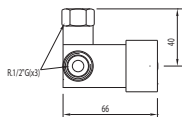

Mezclador dos aguas CON TUBOS FLEXIBLES  
para lavabos TRESTRONIC, TOUCH-TRES y TEMPO-TRES

Cr 1.92.507.30

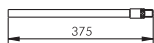

Conexión tubo rígido

M.10x100 (370 mm.)

Cr 91.34.800.2

M.9x100 (320 mm.)

Cr 91.34.800.1

M.8x100 (350 mm.)

Cr 91.34.800.50

OTROS

Ref.: |

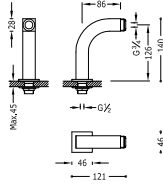

**Codo adaptador baño-ducha**  
2 unidades con silenciador

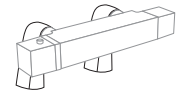

Cr | 299.870.02 |

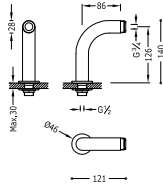

**Codo adaptador baño-ducha**  
2 unidades con silenciador

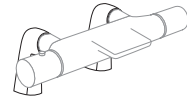

Cr | 299.870.01 |

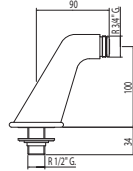

**Codo adaptador baño-ducha**  
2 unidades con silenciador

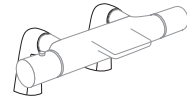

Cr | 024.871.01 |

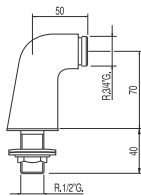

**Codo adaptador baño-ducha**  
2 unidades con silenciador

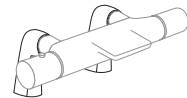

Cr | 1.34.870 |

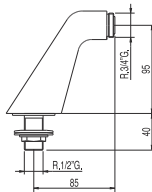

**Codo adaptador baño-ducha**  
2 unidades con silenciador

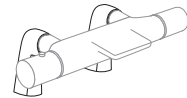

Cr | 1.34.871 |

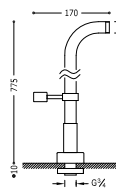

**Tomas de agua a suelo de bañera**  
2 unidades con soporte ducha giratorio

Cr | 1.61.194 |



Ref:

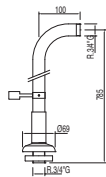

**Tomas de agua a suelo de bañera**  
2 unidades con soporte ducha giratorio

Cr	1.24.194
Lv	024.194.01.LV

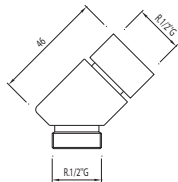

**Codo para ducha**  
para batería bañera de repisa (para ref.: 14.150, 61.150, 62.150, 63.145, 61.161, 87.150, 87.161, 89.150, 89.161)

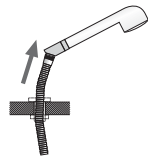

Cr	91.34.145.80
----	--------------

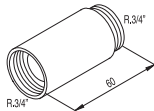

**Alargadera pared adaptador Baño-ducha**  
2 unidades con silenciador



Cr	91.34.872
----	-----------

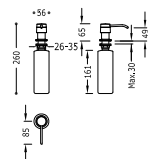

**Dispensador de jabón metálico**  
Para encastrar en encimeras. Capacidad 0,4 litros

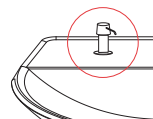

Cr	1.34.741.10
----	-------------

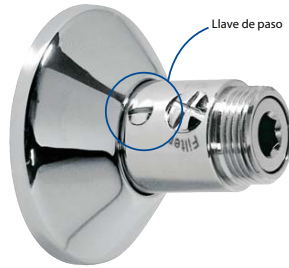

Llave de paso

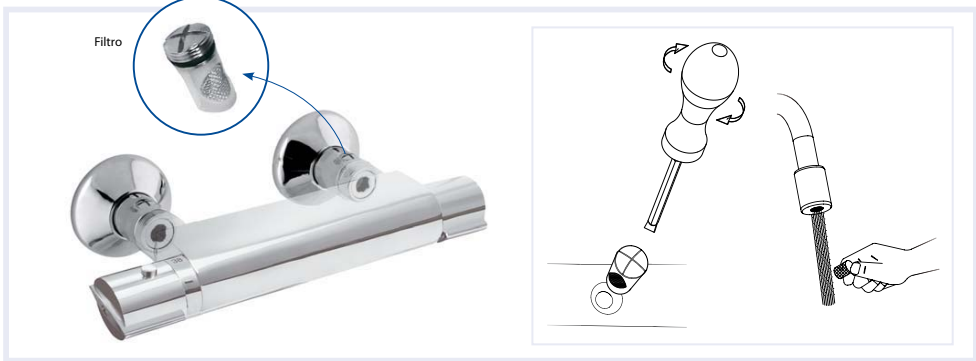

Filtro

Juego de 2 excéntricas con filtro y florón especial para termostáticas

Cr | 1.94.170.19 |



Juego de 2 excéntricas con filtro y florón especial para termostáticas + llave de paso

Cr | 1.94.170.29 |



Llave de paso



VÁLVULAS

Ref.:

Válvula de vaciado

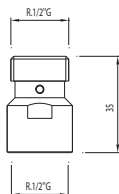

Cr 91.34.789.06

Válvula de vaciado CUADRO  
(para ref.: 07.395, 07.926, 07.131)

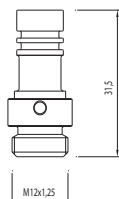

Cr 91.34.789.07

Válvula de vaciado LEX, MAX  
Anterior 2012 (para ref.: 81.385, 81.191)

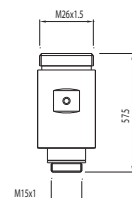

Cr 91.34.789.08

## LIMITADOR ANTILEGIONELA Y ANTIGOTEO



- Limita el caudal del agua liberando de presión el rociador.
- Evita la procreación de bacterias como la legionela.
- Una vez finalizada la utilización de la ducha, éste evita el goteo del rociador.

Funciona con las duchas: 1.34.126, 91.34.729, 91.34.729.06, 91.34.725, 1.34.821, 1.34.617, 1.34.616, 1.34.924, 91.34.824, 91.34.825.10, 1.34.611.  
Funciona con los rociadores\*: 1.34.138.25, 1.34.138.26, 1.34.138.30, 1.93.123.10, 1.34.137.25, 1.34.137.26, 1.34.137.30.

\* Mejor funcionamiento si se elimina el limitador de los rociadores.

**LIMITADOR DE CAUDAL**

Ref.:

Limitador de caudal  
Macho 24/100.

Limitador de caudal  
Hembra 22/100.



		(6 l/m.)
Cr	91.34.682.6	
	<b>Certificado</b>	(8 l/m.)
Cr	91.34.682	
	<b>Certificado</b>	(5 l/m.)
Cr	91.34.682.5	



		(6 l/m.)
Cr	91.34.681.6	
	<b>Certificado</b>	(8 l/m.)
Cr	91.34.681	
	<b>Certificado</b>	(5 l/m.)
Cr	91.34.681.5	



Limitador de caudal  
1/2" - 1/2" Macho-Hembra.



		(8 l/m.)
Cr	91.34.683.8	
	<b>Certificado</b>	(8 l/m.)
Cr	91.34.683	

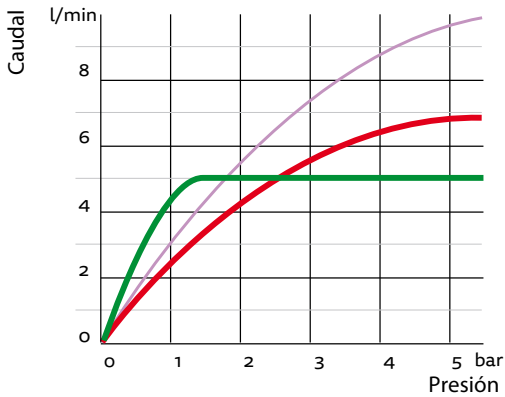

✓ Limitadores = caudal CONSTANTE = **TRES**

✗ Reductores = caudal VARIABLE = OTROS

● Aireadores convencionales



AIREADORES

Ref.:

Aireador macho Cascade SLC

24/100 para lavabo, bidé y fregadero y para grupos baño-ducha



Cr	91.34.673	
Ac	91.34.673.5.0.3	
Lv	91.34.673.5.0.1	

Aireador hembra Cascade SLC

22/100 para caños de tubo



Cr	91.34.672	
Lv	91.34.672.5.0.1	

Aireador macho

24/100 para grupos baño-ducha. Retención "C"



Cr	299.663.10	
----	------------	--

Aireador

Macho 24/100



	299.610.01	
--	------------	--

Aireador

Macho 16/100



	299.610.02	
--	------------	--

Rompeaguas orientable + llave

Macho 24/100



	299.610.06	
--	------------	--



Filtro ANTICLORO DUCHAS  
Agua filtrada hasta los 10.000 litros.

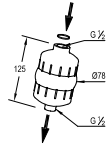

1.30.355.90

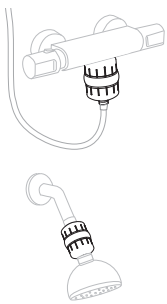

Agua filtrada **sin cloro** también en la ducha.  
**Ideal para personas alérgicas al cloro.**

El cloro es absorbido por la piel cuando nos duchamos, siendo éste un componente tóxico. Nuestro filtro disminuye la cantidad de impurezas, sedimentos, olor y cloro hasta un 99%.

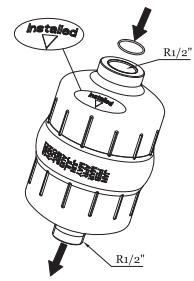

! Agua filtrada hasta los **10.000 litros**







## CUADRO-TRES



Lavabos

378



Bidé

387



Monomandos de superficie

388



Monomandos empotrados

389



Bañeras de repisa

391



Termostáticas de superficie

392



Accesorios

345

[www.tresgriferia.com](http://www.tresgriferia.com)



**RECAMBIOS**  
DE LOS ARTICULOS EN  
[www.tresgriferia.com](http://www.tresgriferia.com)

**Monomando lavabo**

con caño cascada. \*NOTA: La grifería con caño cascada se acompaña con 2 llaves de regulación con filtro (Ref: 91.34.525).

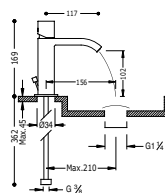

299.190.01  
Cr **006.101.02**



299.190.01  
Cr **006.101.02.D**

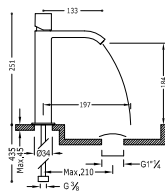

299.190.01  
Cr **006.610.02**

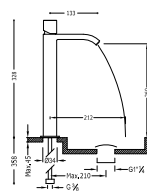





299.190.01  
Cr **006.810.02**



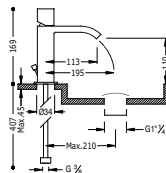



**Monomando lavabo**

con caño cascada libre. \* NOTA: La grifería con caño cascada se acompaña con 2 llaves de regulación con filtro (Ref: 91.34.525).

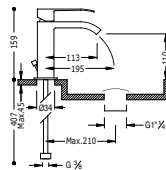





  
 299.190.02  
 Cr **006.110.02**



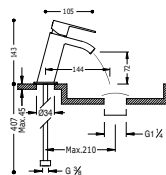

  
 299.190.02  
 Cr **006.110.01**

**Monomando lavabo**

con caño cascada. NOTA: La grifería con caño cascada se acompaña con 2 llaves de regulación con filtro (Ref: 91.34.525).







  
 299.190.01  
 Cr **006.201.01**

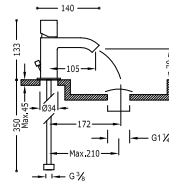

Ref: |

Monomando lavabo



Cr | 1.07.103

Cr | 1.07.103.DA

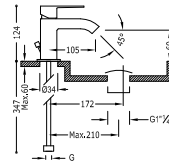

Cr | 1.06.103

Cr | 1.06.103.DA

Monomando lavabo  
caño de 34x10 mm.

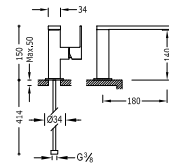
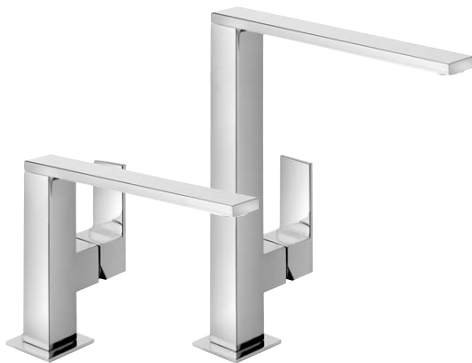

Cr | 1.06.205.01

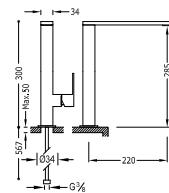

Cr | 006.485.01

Monomando lavabo  
caño de 35x15 mm.

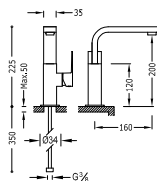

Cr 1.06.603

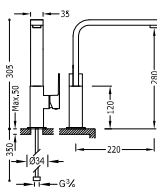

Cr 1.06.604

Monomando lavabo  
caño de 22x22 mm.

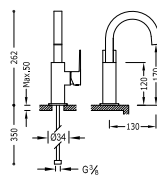

Cr 1.06.605

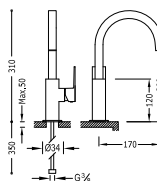

Cr 1.06.606

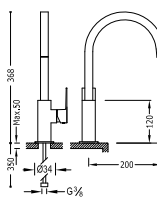

Cr 1.06.607







Ref:

**Bimando vertical**  
caño de 35x15 mm.

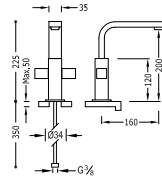

Cr **1.08.604**

**Bimando vertical**  
caño de 22x22 mm.

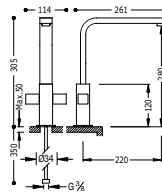

Cr **1.08.496**

**Bimando vertical**  
caño de 22x22 mm.

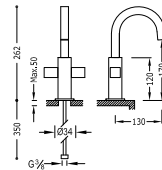

Cr **1.08.605**

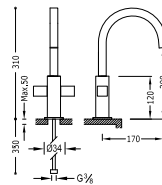

Cr **1.08.606**

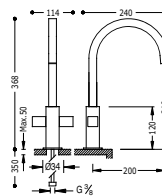

Cr **1.08.497**

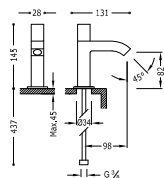

Grifo lavabo 1 agua o premezclada



91.08.295.10

Cr 1.07.503

Monomando mural  
con caño cascada

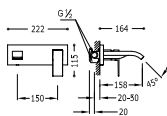

299.190.01

Cr 006.260.01

Monomando mural  
con caño cascada

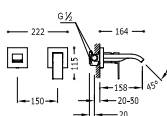

299.190.01

Cr 006.260.10

Monomando mural  
con aireador

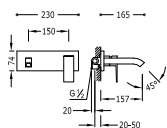

91.30.190

Cr 1.06.200

Monomando mural  
con aireador

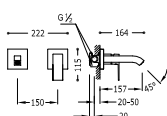

91.30.190

Cr 006.200.10

Monomando mural

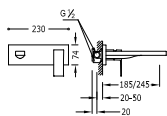

91.30.190

(185 mm.)  
Cr 006.200.03



91.30.190

(245 mm.)  
Cr 006.200.04



Ref:

**Monomando mural**

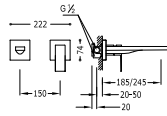

91.30.190 (185 mm.)  
Cr **006.200.12**

91.30.190 (245 mm.)  
Cr **006.200.11**

**Monomando lavabo de repisa**  
caño de 22x22 mm.

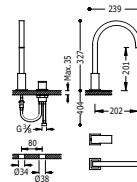

360° 91.30.190  
Cr **006.105.03**

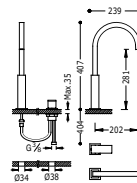

360° 91.30.190  
Cr **006.105.04**

**Bimando mural**  
con caño cascada

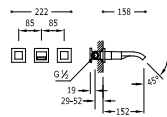

91.34.262  
Cr **008.152.01**

**Bimando mural**  
con aireador

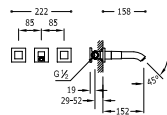

91.34.282  
Cr **008.151.01**

Bimando mural

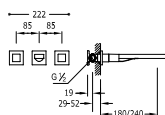

Cr **008.153.01**



Cr **008.154.01**

Bimando repisa

caño 35x15 mm. con aireador rectangular oculto

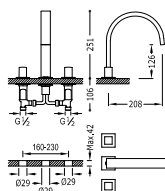

Cr **008.105.01**

Bimando repisa

caño 22x22 mm.

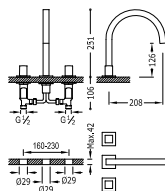

Cr **008.105.02**

Bimando repisa

caño de 22x22 mm.

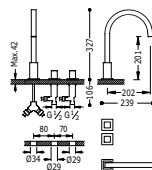

Cr **008.105.03**

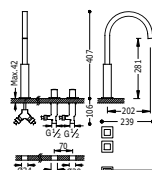

Cr **008.105.04**



Monomando bidé

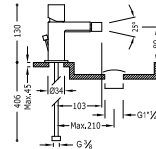

91.30.190  
Cr **007.120.01**

91.30.190  
Cr **007.120.01.D**

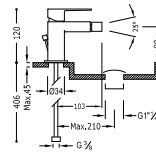

91.30.190  
Cr **006.120.01**

91.30.190  
Cr **006.120.01.D**

Monomando bidé

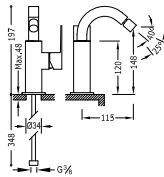

91.30.190  
Cr **1.06.124**

Bimando bidé

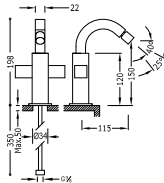

91.08.292.10  
91.08.292.20  
Cr **1.08.124**

Monomando bidé con duchita

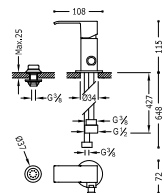

91.30.190  
Cr **006.130.01**

Ref:

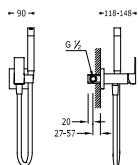

### Monomando empotrar para bidé WC

Soporte derecha o izquierda, cambiable. Ducha de latón con record limitador 5 l/m. Antigoteo y flexo SATIN. \* Opción para paredes de Pladur



91.30.190

Cr 006.123.01

Cr 006.123.02\*

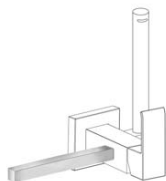

### Accesorio porta toallas

180 mm. (para ref.: 006.123.01, 006.123.02). \* NOTA: Soporte derecha o izquierda, cambiable.

Cr 034.124.02

## MONOMANDOS DE SUPERFICIE

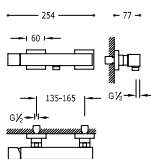

### Monomando ducha

Ducha de mano anticalcárea (006.639.01) con soporte orientable y flexo SATIN (91.34.609.15).



91.30.190

Cr 1.07.167

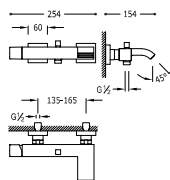

### Monomando bañera-ducha

con cascada. Ducha de mano anticalcárea (006.639.01) con soporte orientable. Flexo SATIN (91.34.609).



91.30.190

Cr 1.07.170.02

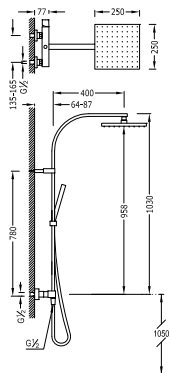

### Conjunto ducha monomando anticalcárea

- Ducha fija 250x250 mm. con rótula. (1.34.138.26).
- Ducha móvil anticalcárea (006.639.01).
- Flexo SATIN (91.34.609.15).



91.30.190

Cr 007.191.01





MONOMANDOS EMPOTRADOS

Ref.:

**Monomando empotrar (1 vía)**  
cuerpo empotrado incluido

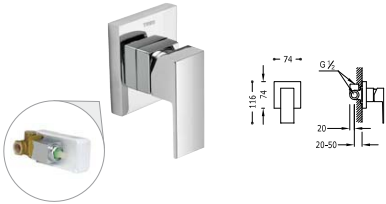

91.30.190 RECADABA  
Cr 1.06.177

**Monomando empotrar (2 vías)**  
cuerpo empotrado incluido

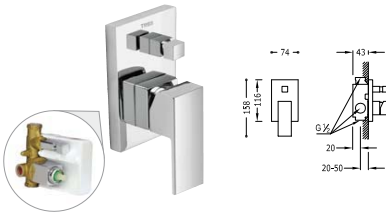

91.30.190 RECADABA  
Cr 1.06.180

**Alargadera para monomando empotrar ducha**



Cr 1.06.177.10

**Alargadera para monomando empotrar baño-ducha**

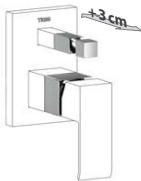

Cr 1.06.180.10

**Kit de ducha monomando empotrado**

con cierre y regulación de caudal.

- Cuerpo empotrado incluido
- Ducha fija 300x300 mm. con rótula. Material Latón. (1.34.138.30).
- Soporte con toma pared (006.182.01).
- Ducha móvil anticalcárea (006.639.01).
- Flexo SATIN (91.34.609.15).

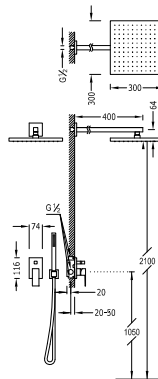

91.30.190 RECADABA  
Cr 1.06.980



N

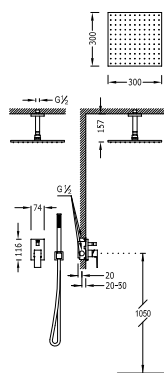

**Kit de ducha monomando empotrado**

con cierre y regulación de caudal.

- Cuerpo empotrado incluido
- Ducha fija 300x300 mm. con rótula. Material Latón. (1.34.138.30).
- Soporte con toma pared (006.182.01).
- Ducha móvil anticalcárea (006.639.01).
- Flexo SATIN (91.34.609.15).



91.30.190

Cr 006.180.80

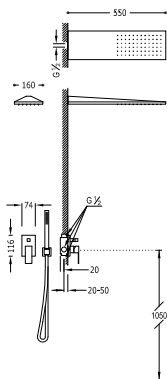

**Kit de ducha monomando empotrado**

con cierre y regulación de caudal.

- Cuerpo empotrado incluido
- Rociador ducha INOX a pared 160x550 mm. (299.903.03).
- Soporte con toma pared (006.182.01).
- Ducha móvil anticalcárea (006.639.01).
- Flexo SATIN (91.34.609.15).



91.30.190

Cr 006.180.03

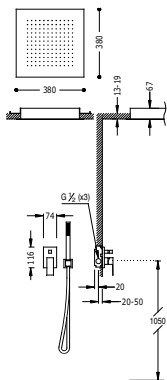

**Kit de ducha monomando empotrado**

con cierre y regulación de caudal.

- Cuerpo empotrado incluido
- Rociador ducha INOX a techo 380x380 mm. (1.34.944).
- Soporte con toma pared (006.182.01).
- Ducha móvil anticalcárea (006.639.01).
- Flexo SATIN (91.34.609.15).



91.30.190

Cr 006.980.01







**BAÑERAS DE REPISA**

Ref.:

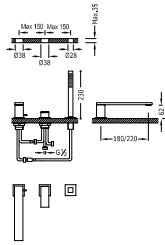

**Monomando bañera de repisa**

con ducha anticalcárea (006.639.01).

- Caudal: 3 bar ~ 13 l/m.
- Compatible con el kit depósito ref: 200.245.01.
- NOTA: ver longitud caño.

91.30.190 (180 mm.)  
Cr **006.161.06**

91.30.190 (220 mm.)  
Cr **006.161.04**

91.30.190 (180 mm.)  
Cr **006.161.05**

91.30.190 (220 mm.)  
Cr **006.161.03**



**Kit depósito para bañeras de repisa**

(para ref.: 006.161.06, 006.161.04, 006.161.05, 006.161.03, 205.161.03, 205.161.01).

Cr **200.245.01**



**Válvula bañera con toma drenaje**

Cr **1.34.445**

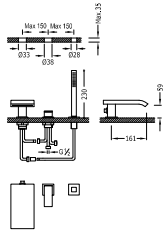

**Monomando bañera de repisa**

con caño cascada y ducha móvil anticalcárea (006.639.01).

- Caudal: 3 bar ~ 13 l/m.
- Compatible con el kit depósito ref: 1.06.245.

91.30.190  
Cr **1.07.161.02**

91.30.190  
Cr **1.06.161.02**



**Kit depósito para bañeras de repisa**

(para ref.: 1.07.161.02, 1.06.161.02).

Cr **1.06.245**



**Válvula bañera con toma drenaje**

Cr **1.34.445**



TERMOSTÁTICAS DE SUPERFICIE

Ref.:

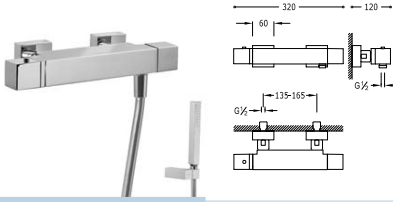

Ducha termostática

(Ducha de mano anticalcárea con soporte orientable y flexo SATIN (91.34.609.15)).



Cr 1.07.164



Cr 1.07.164,9

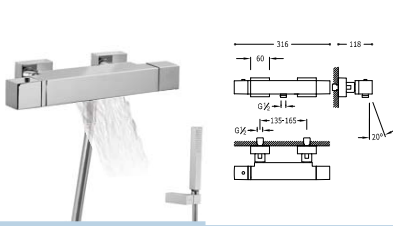

Bañera-ducha termostática

con cascada (Ducha de mano anticalcárea con soporte orientable y flexo SATIN (91.34.609)).



Cr 1.07.174



Cr 1.07.174,9

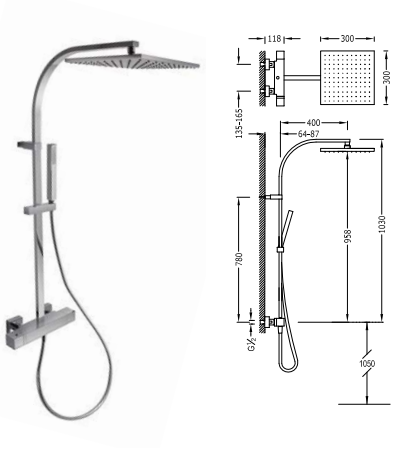

Conjunto ducha termostática

- Ducha fija 300x300 mm. con rótula. Material Latón (1.34.138.30).  
- Ducha móvil anticalcárea (006.639.01).  
- Flexo SATIN (91.34.609.15).  
- Inversor integrado en el regulador de caudal.



Cr 1.07.395

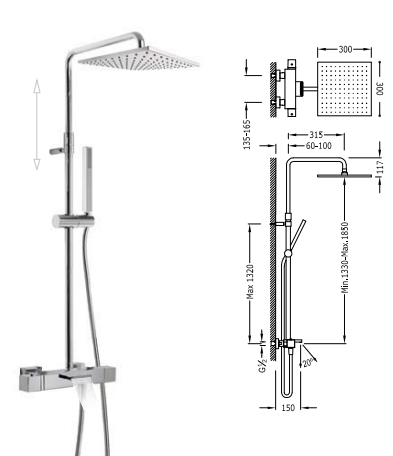

Conjunto bañera-ducha termostática

- Ducha fija 300x300 mm. con rótula. Material Latón.  
- Ducha móvil anticalcárea (006.639.01).  
- Flexo SATIN (91.34.609).  
- Barra telescópica.



Cr 007.312.01





LLAVES DE PASO

Ref.: |

Llave de paso 1/2"

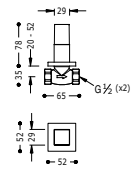

Cr | 007.155.01 |

Llave de paso 3/4"

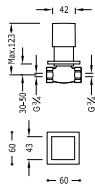

Cr | 1.07.511 |





## MAX-TRES



Lavabos

396



Bidé

405



Monomandos de superficie

407



Monomandos empotrados

408



Bañeras de repisa

410



Termostáticas de superficie

412



Accesorios

346

[www.tresgriferia.com](http://www.tresgriferia.com)



**RECAMBIOS**  
DE LOS ARTÍCULOS EN  
[www.tresgriferia.com](http://www.tresgriferia.com)

Monomando lavabo

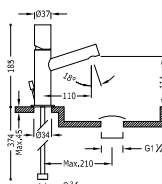

91.07.190.05  
Cr **061.103.01**



91.07.190.05  
Cr **061.103.01.D**

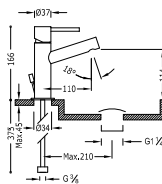

91.07.190.05  
Cr **062.103.01**



91.07.190.05  
Cr **062.103.01.D**

Monomando lavabo  
Caño largo

MEDIDAS ESPECIALES

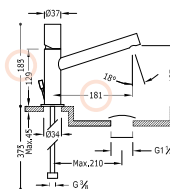

91.07.190.05

Cr 061.203.01

91.07.190.05

Cr 061.203.01.D

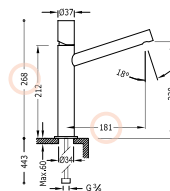

91.07.190.05

Cr 061.206.01

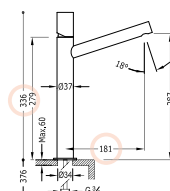

91.07.190.05

Cr 061.207.01

Monomando lavabo  
Caño largo

MEDIDAS ESPECIALES

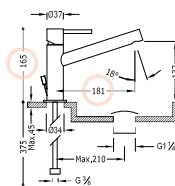

91 07.190.05  
Cr **062.203.01**

91 07.190.05  
Cr **062.203.01.D**

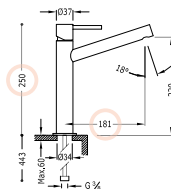

91 07.190.05  
Cr **062.206.01**

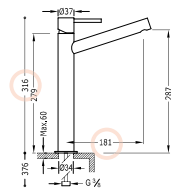

91 07.190.05  
Cr **062.207.01**



**Monomando lavabo**

NOTA: La grifería con caño cascada se acompaña con 2 llaves de regulación con filtro (Ref: 91.34.525).

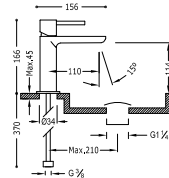
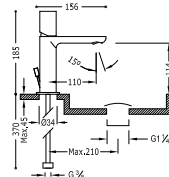

Cr	91.30.190	<b>061.103.02</b>	
Cr	91.30.190	<b>061.103.02.D</b>	
Cr	91.30.190	<b>061.103.03</b>	
Cr	91.30.190	<b>061.103.03.D</b>	

**Monomando lavabo**

con caño cascada libre. NOTA: La grifería con caño cascada se acompaña con 2 llaves de regulación con filtro (Ref: 91.34.525).

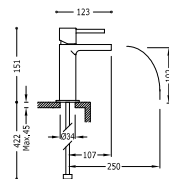
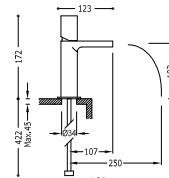

Cr	91.30.190	<b>061.110.01</b>	

Cr	91.30.190	<b>062.110.01</b>	

Monomando lavabo

NOTA: La grifería con caño cascada se acompaña con 2 llaves de regulación con filtro (Ref. 91.34.525).

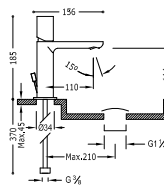

91.30.190   

Cr 061.103.02

91.30.190   

Cr 061.103.02.D

91.30.190   

Cr 061.103.03

91.30.190   

Cr 061.103.03.D

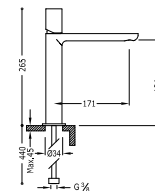

91.30.190   

Cr 061.203.04

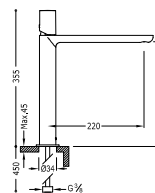

91.30.190   

Cr 061.203.06



**Monomando lavabo**

NOTA: La grifería con caño cascada se acompaña con 2 llaves de regulación con filtro (Ref. 91.34.525).

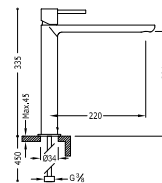
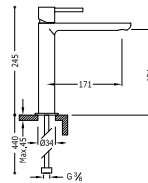
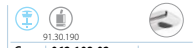
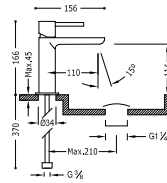

**Monomando lavabo**  
caño de 34x9 mm.

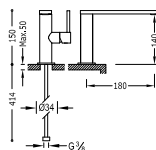

Cr 062.905.03

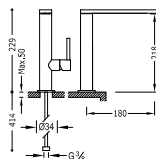

Cr 062.905.02

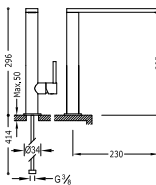

Cr 062.905.01



**Bimando lavabo**

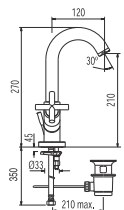

Cr 1.63.103

Cr 1.68.103

**Lavabo electrónico 1 agua TOUCH-TRES**  
Sistema sensible al tacto. Sólo tocar (NO pulsar)

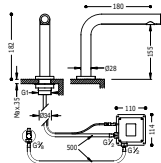

Cr 061.447.01

**Lavabo electrónico mezclador TOUCH-TRES**  
Sistema sensible al tacto. Sólo tocar (NO pulsar). NOTA: Incluye un grifo mezclador dos aguas con tubos flexibles (ref: 1.92.507.30).

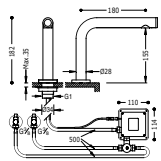

Cr 061.448.01

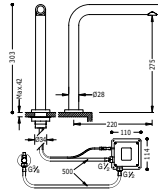

**Lavabo electrónico 1 agua TOUCH-TRES**  
Sistema sensible al tacto. Sólo tocar (NO pulsar)



Cr | **1.61.445**

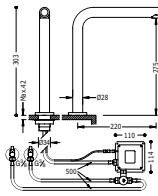

**Lavabo electrónico mezclador TOUCH-TRES**  
Sistema sensible al tacto. Sólo tocar (NO pulsar). NOTA: Incluye un grifo mezclador dos aguas con tubos flexibles (ref: 1.92.507.30).



Cr | **1.61.446**

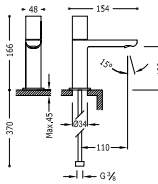

**Grifo lavabo 1 agua o premezclada**



Cr | **200.503.01**

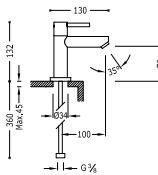

**Grifo lavabo 1 agua o premezclada**



Cr | **1.62.503**

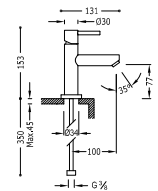

**Monomando lavabo Ø 30 mm.**



Cr | **1.62.603**

Monomando mural

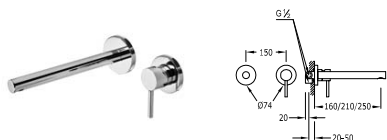

91.30.190 (160 mm.)  
Cr | **062.200.70**

91.30.190 (210 mm.)  
Cr | **062.200.71**

91.30.190 (250 mm.)  
Cr | **062.200.03**

Monomando mural

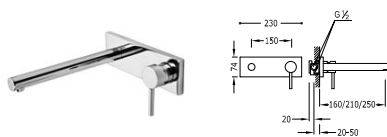

91.34.592 (160 mm.)  
Cr | **062.200.01**

91.34.592 (210 mm.)  
Cr | **062.200.02**

91.34.592 (250 mm.)  
Cr | **1.62.200**

Monomando mural  
con caño cascada

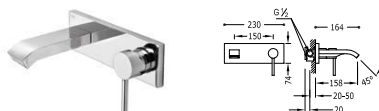

299.190.01  
Cr | **062.260.10**

Batería lavabo mural

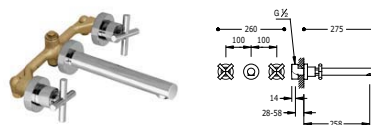

91.34.282 (160 mm.)  
Cr | **1.63.152**

91.34.282 (250 mm.)  
Cr | **1.63.151**

Batería lavabo



360+  
Cr | **1.68.105**



BIDÉ

Ref.:

Monomando bidé

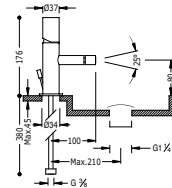

91.07.190.05

Cr | 061.120.01

91.07.190.05

Cr | 061.120.01.D

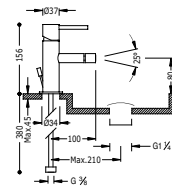

91.07.190.05

Cr | 062.120.01

91.07.190.05

Cr | 062.120.01.D

Monomando bidé

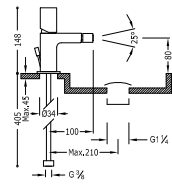

91.30.190

Cr | 061.220.01

91.30.190

Cr | 061.220.01.D

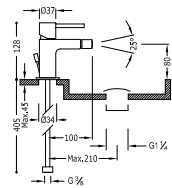

91.30.190

Cr | 062.220.01

91.30.190

Cr | 062.220.01.D

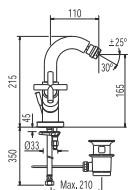

Bimando bidé



Cr 1.63.120



Cr 1.68.120

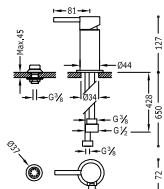

Monomando bidé con duchita



91.34.592

Cr 062.130.01

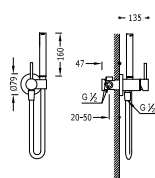

Monomando empotrar para bidé WC

SopORTE derecha o izquierda, cambiABLE. DuchA de latón con racord limitador 5 l/m. Antigoteo y flexo SATIN. \* Opción para paredes de Pladur



91.34.591

Cr 1.34.123

Cr 1.34.122\*

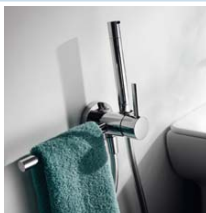

Accesorio porta toallas

180 mm. (para ref.: 1.34.122, 1.34.123, 1.81.122, 1.81.123, 205.222.01, 205.223.01). NOTA: Soporte derecha o izquierda, cambiABLE.

Cr 034.124.01





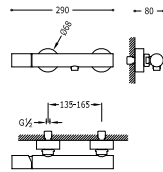

**Monomando ducha**

Ducha de mano anticálcea (299.748.02) con soporte orientable y flexo SATIN (91.34.609.15).



91.30.190

Cr 061.167.01

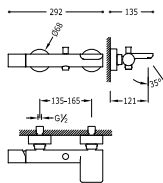

**Monomando bañera-ducha**

con cascada. Duchas de mano anticálcea (299.748.02) con soporte orientable y flexo SATIN (91.34.609).



91.30.190

Cr 061.170.01

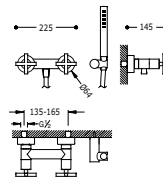

**Grupo ducha**

Ducha de mano anticálcea (034.116.01) con soporte orientable y flexo SATIN (91.34.609.15).



91.30.190

Cr 1.63.868

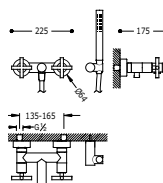

**Grupo bañera**

Ducha de mano anticálcea (034.116.01) con soporte orientable y flexo SATIN (91.34.609).



91.30.190

Cr 1.63.874

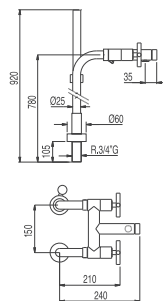

**Grupo bañera con tomas a suelo**

Ducha de mano anticálcea (034.116.01) con soporte orientable y flexo SATIN (91.34.609).



91.30.190

Cr 1.63.194

MONOMANDOS EMPOTRADOS

Ref.:

Monomando empotrar (1 vía)  
cuerpo empotrado incluido

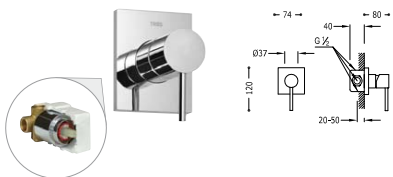

91.30.190  
Cr 062.177.02

Monomando empotrar (2 vías)  
cuerpo empotrado incluido

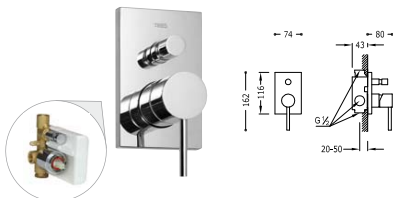

91.30.190  
Cr 062.180.02

Monomando empotrar (1 vía)  
cuerpo empotrado incluido

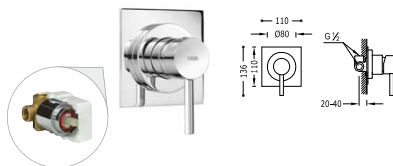

91.34.288  
Cr 1.62.177

Monomando empotrar (2 vías)  
cuerpo empotrado incluido

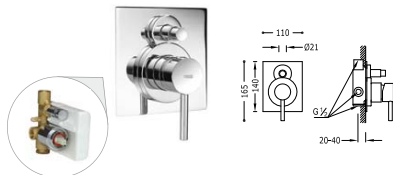

91.34.288  
Cr 1.62.180

Distribuidor empotrado de 5 vías  
con cierre y regulación de caudal (1 entrada y 5 salidas). Cuerpo empotrado incluido.

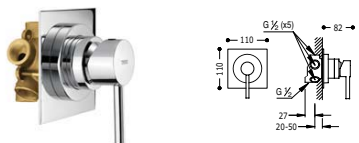

Cr 1.34.550

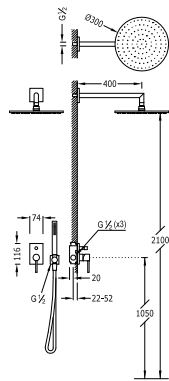

**Kit de ducha monomando empotrado**

- con cierre y regulación de caudal.
- Cuerpo empotrado incluido
- Ducha fija Ø 300 mm. con rótula. (1.34.137.30). Material Latón.
- Soporte con toma pared (061.182.01).
- Ducha móvil anticalcárea (034.116.01).
- Flexo SATIN (91.34.609.15).



91.30.190

Cr 062.980.01

N

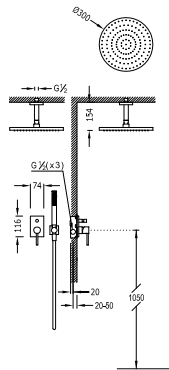

**Kit de ducha monomando empotrado**

- con cierre y regulación de caudal.
- Cuerpo empotrado incluido
- Ducha fija Ø 300 mm. con rótula. (1.34.137.30). Material Latón.
- Soporte con toma pared (061.182.01).
- Ducha móvil anticalcárea (034.116.01).
- Flexo SATIN (91.34.609.15).



91.30.190

Cr 062.180.80

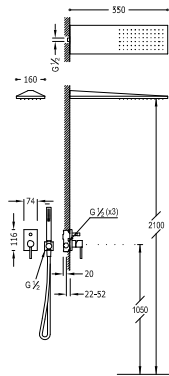

**Kit de ducha monomando empotrado**

- con cierre y regulación de caudal.
- Cuerpo empotrado incluido
- Rociador ducha INOX a pared 160x550 mm. (299.903.03).
- Soporte con toma pared (061.182.01).
- Ducha móvil anticalcárea (034.116.01).
- Flexo SATIN (91.34.609.15).



91.30.190

Cr 062.516.01

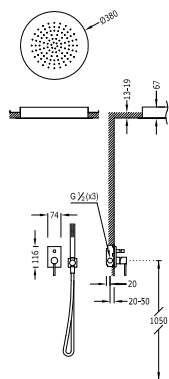

### Kit de ducha monomando empotrado

con cierre y regulación de caudal.

- Cuerpo empotrado incluido
- Rociador ducha INOX a techo Ø 380 mm. (1.34.940).
- Soporte con toma pared (061.182.01).
- Ducha móvil anticalcárea (034.116.01).
- Flexo SATIN (91.34.609.15).



91.30.190

Cr 062.180.09

### BAÑERAS DE REPISA

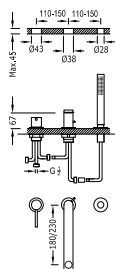

### Monomando bañera de repisa

con ducha anticalcárea (034.116.01).

- Caudal: 3 bar ~ 16 l/m.
- Compatible con el kit depósito ref: 203.245.01.
- NOTA: ver longitud caño.



91.34.591 (180 mm.)

Cr 062.161.03



91.34.591 (230 mm.)

Cr 062.161.02



### Kit depósito para bañeras de repisa

(para ref.: 062.161.03, 062.161.02, 200.162.03, 200.162.01, 081.161.04, 081.161.03, 203.161.02, 203.161.01).

Cr 203.245.01



### Válvula bañera con toma drenaje

Cr 1.34.445



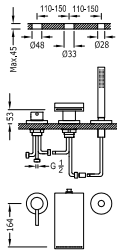

**Monomando bañera de repisa**

con caño cascada y ducha móvil anticalcárea (034.116.01).  
- Caudal: 3 bar ~ 17 l/m.  
- Compatible con el kit depósito ref: 1.62.245.

91.34.288  
Cr **061.161.01**

91.34.288  
Cr **1.62.161**



**Kit depósito para bañeras de repisa**  
(para ref: 061.161.01, 1.62.161, 261.150.01, 262.150.01).

Cr **1.62.245**



**Válvula bañera con toma drenaje**

Cr **1.34.445**

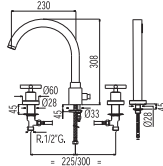

**Batería bañera de repisa**

Ducha móvil anticalcárea (034.116.01).  
- Caudal: 3 bar ~ 17 l/m.  
- Compatible con el kit depósito ref: 1.34.345.

360°  
Cr **1.63.145**



**Kit depósito para bañeras de repisa**  
(para ref: 1.63.145, 1.32.145, 1.24.146).

Cr **1.34.345**



**Válvula bañera con toma drenaje**

Cr **1.34.445**



TERMOSTÁTICAS DE SUPERFICIE

Ref.:

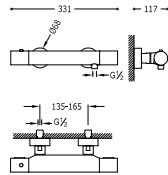

Ducha termostática

(Ducha de mano anticálcarea (299.748.02) con soporte orientable y flexo SATIN (91.34.609.15)).



299.195.03  
Cr | **061.162.01**

299.195.03  
Cr | **061.162.09**

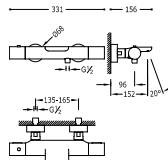

Bañera-ducha termostática

con cascada (Ducha de mano anticálcarea (299.748.02) con soporte orientable y flexo SATIN (91.34.609)).



299.195.03  
Cr | **061.172.01**

299.195.03  
Cr | **061.172.09**

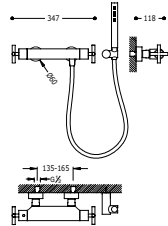

Ducha termostática

(Ducha de mano anticálcarea (034.116.01) con soporte orientable y flexo SATIN (91.34.609.15)).



299.163.01  
Cr | **063.162.01**

299.163.01  
Cr | **063.162.09**

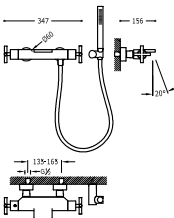

Bañera-ducha termostática

Con cascada (Ducha de mano anticálcarea (034.116.01) con soporte orientable y flexo SATIN (91.34.609)).



299.163.01  
Cr | **063.172.01**

299.163.01  
Cr | **063.172.09**

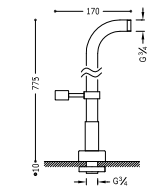

Tomas de agua a suelo de bañera

2 unidades con soporte ducha giratorio

Cr | **1.61.194**

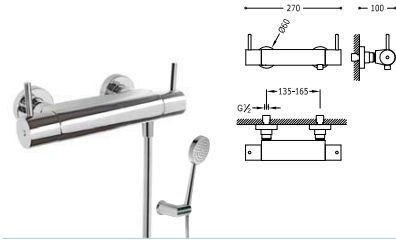

**Ducha termostática**

Ducha de mano anticalcárea (299.631.03) con soporte orientable y flexo SATIN (91.34.609.15). Indicado para personas con discapacidades físicas



299.195.09  
Cr **090.264.01**



299.195.09  
Cr **090.964.01**

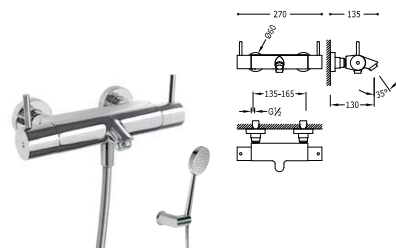

**Bañera-ducha termostática**

Ducha de mano anticalcárea (299.631.03) con soporte orientable y flexo SATIN (91.34.609). Indicado para personas con discapacidades físicas



299.195.09  
Cr **090.274.01**



299.195.09  
Cr **090.974.01**

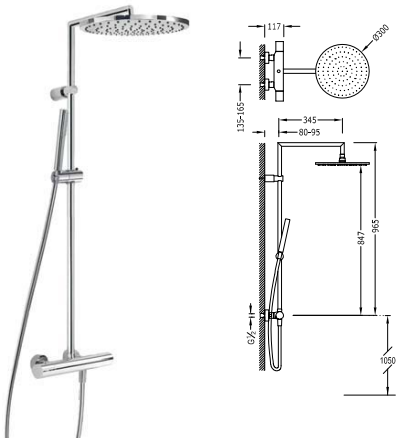

**Conjunto ducha termostática**

- Ducha fija Ø 300 mm. con rótula. (1.34.137.30). Material Latón.
- Ducha móvil anticalcárea (034.116.01).
- Flexo SATIN (91.34.609.15).
- Inversor integrado en el regulador de caudal.



299.195.03  
Cr **061.393.01**



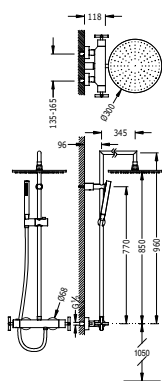

**Conjunto ducha termostática**

- Ducha fija Ø 300 mm. con rótula. (1.34.137.30). Material Latón.
- Ducha móvil anticalcárea (034.116.01).
- Flexo SATIN (91.34.609.15).
- Inversor integrado en el regulador de caudal.



299.163.01  
Cr **063.393.01**

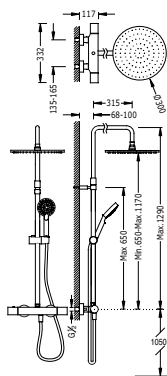

**Conjunto ducha termostática**

- Ducha fija Ø 300 mm. con rótula. (1.34.137.30). Material Latón.
- Ducha móvil anticalcárea (299.748.02).
- Flexo SATIN (91.34.609.15).
- Barra telescópica.
- Inversor integrado en el regulador de caudal.



299.195.03  
Cr **061.210.01**

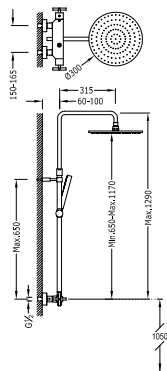

**Conjunto ducha termostática**

- Ducha fija Ø 300 mm. con rótula. (1.34.137.30). Material Latón.
- Ducha móvil anticalcárea (034.116.01).
- Flexo SATIN (91.34.609.15).
- Barra telescópica.
- Inversor integrado en el regulador de caudal.



299.163.01  
Cr **063.211.01**



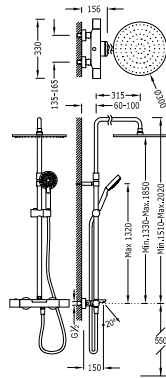

**Conjunto bañera-ducha termostática**

- Ducha fija Ø 300 mm. con rótula. (1.34.137.30). Material Latón.
- Ducha móvil anticálcarea (299.748.02).
- Flexo SATIN (91.34.609).
- Barra telescópica.



Cr 062.312.01

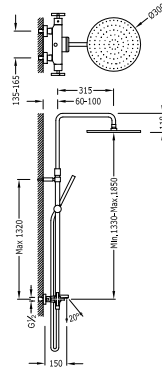

**Conjunto bañera-ducha termostática**

- Ducha fija Ø 300 mm. con rótula. (1.34.137.30). Material Latón.
- Ducha móvil anticálcarea (034.116.01).
- Flexo SATIN (91.34.609).
- Barra telescópica.



Cr 063.312.01

**LLAVES DE PASO**

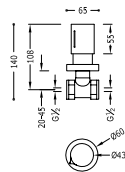

**Llave de paso 1/2"**

Cr 061.155.01

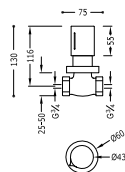

**Llave de paso 3/4"**

Cr 061.511.01



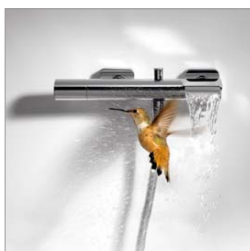

## LOFT-TRES



Lavabos

418



Bidé

422



Monomandos de superficie

424



Monomandos empotrados

424



Bañeras de repisa

426



Termostáticas de superficie

426



Accesorios

348

[www.tresgriferia.com](http://www.tresgriferia.com)



**RECAMBIOS**  
DE LOS ARTICULOS EN  
[www.tresgriferia.com](http://www.tresgriferia.com)

LAVABOS

Ref.: |

Monomando lavabo

con caño cascada. \*NOTA: La grifería con caño cascada se acompaña con 2 llaves de regulación con filtro (Ref: 91.34.525).

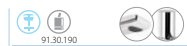
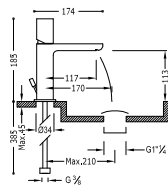

Cr 200.103.02



Cr 200.103.02.D



Cr 200.101.02



Cr 200.101.02.D

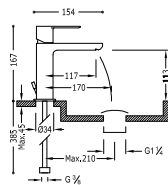

Cr 200.103.01



Cr 200.103.01.D



Cr 200.101.01



Cr 200.101.01.D

Monomando lavabo

con caño cascada libre. \*NOTA: La grifería con caño cascada se acompaña con 2 llaves de regulación con filtro (Ref: 91.34.525).

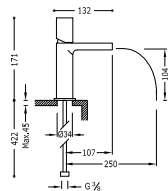

Cr 200.110.02

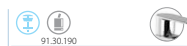
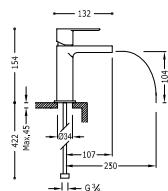

Cr 200.110.01

**Monomando lavabo**

con caño cascada. \*NOTA: La grifería con caño cascada se acompaña con 2 llaves de regulación con filtro (Ref: 91.34.525).

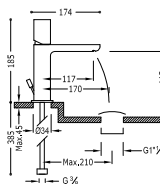
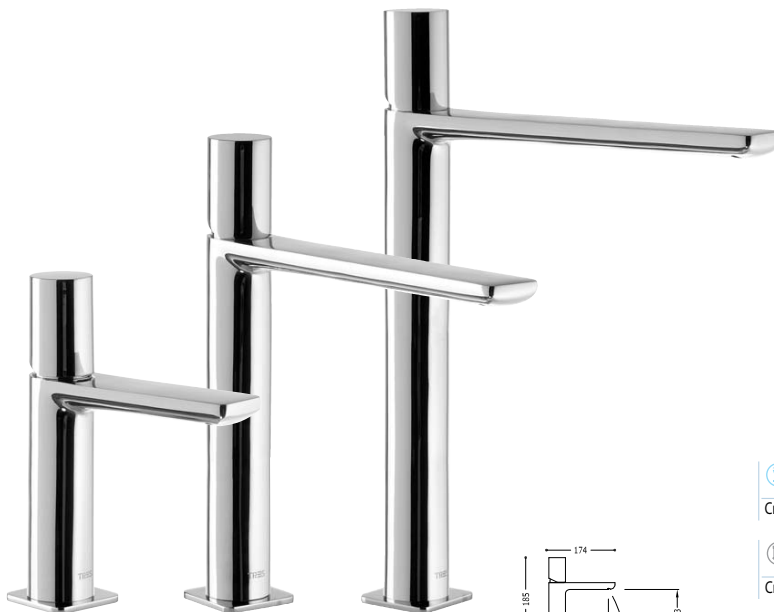

Cr 200.103.02



Cr 200.103.02.D



Cr 200.101.02



Cr 200.101.02.D

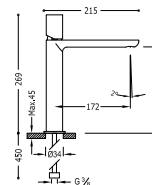

Cr 200.203.04

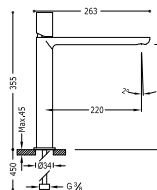

Cr 200.203.06

**Monomando lavabo**

con caño cascada. \*NOTA: La grifería con caño cascada se acompaña con 2 llaves de regulación con filtro (Ref: 91.34.525).

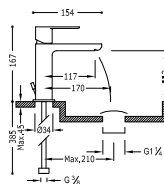

91.30.190   
 Cr **200.103.01**

91.30.190   
 Cr **200.103.01.D**

91.30.190   
 Cr **200.101.01**

91.30.190   
 Cr **200.101.01.D**

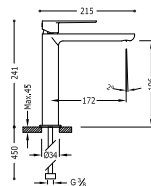

91.30.190   
 Cr **200.203.03**

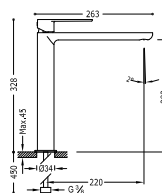

91.30.190   
 Cr **200.203.05**

Monomando lavabo

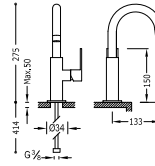

Cr 200.205.04

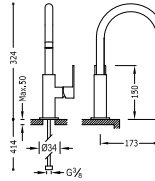

Cr 200.205.05

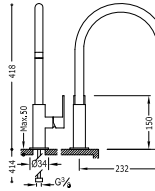

Cr 200.205.06



Monomando lavabo  
caño de 35x15 mm.

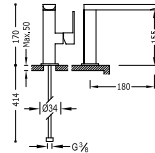

Cr 200.205.01

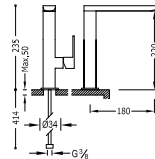

Cr 200.205.02

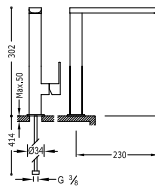

Cr 200.205.03



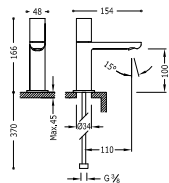

Grifo lavabo 1 agua o premezclada



91.34.282

Cr 200.503.01



Monomando mural

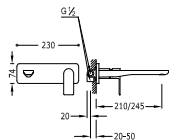

91.30.190 (210 mm.)

Cr 200.200.03



91.30.190 (245 mm.)

Cr 200.200.02



Monomando mural con caño cascada

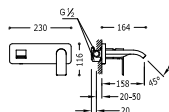

299.190.01

Cr 200.260.10

BIDÉ

Monomando bidé

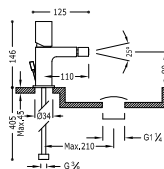

91.30.190

Cr 200.120.02



91.30.190

Cr 200.120.02.D

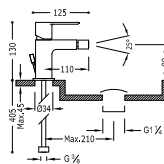

91.30.190

Cr 200.120.01



91.30.190

Cr 200.120.01.D





Ref: |

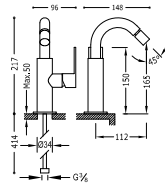

Monomando bidé

360° 91.30.190  
Cr | **200.224.01**

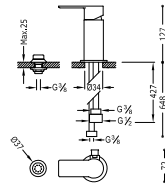

Monomando bidé con duchita

91.34.592  
Cr | **200.130.01**

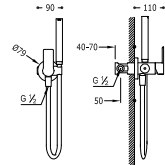

Monomando empotrar para bidé WC

Soporte derecha o izquierda, cambiable. Duchá de latón con record limitador 5 l/m. Antigoteo y flexo SATIN. \* Opción para paredes de Pladur

91.34.591  
Cr | **205.223.01**  
Cr | **205.222.01\***

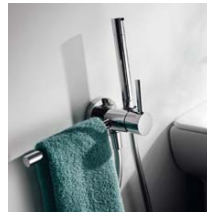

Accesorio porta toallas

180 mm. (para ref.: 1.34.122, 1.34.123, 1.81.122, 1.81.123, 205.222.01, 205.223.01). NOTA: Soporte derecha o izquierda, cambiable.

Cr | **034.124.01**

MONOMANDOS DE SUPERFICIE

Ref.:

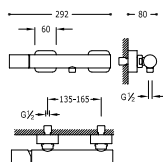

Monomando ducha

Ducha de mano anticalcárea (034.639.01) con soporte orientable y flexo SATIN (91.34.609.15).

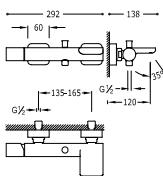

Monomando bañera-ducha

con cascada. Ducha de mano anticalcárea (034.639.01) con soporte orientable y flexo SATIN (91.34.609).



MONOMANDOS EMPOTRADOS

Monomando empotrar (1 vía)

cuerpo empotrado incluido

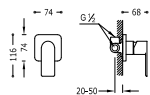

Monomando empotrar (2 vías)

cuerpo empotrado incluido

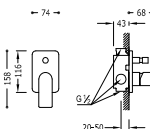

Alargadera para monomando empotrar baño-ducha



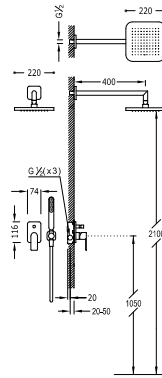

**Kit de ducha monomando empotrado**

- con cierre y regulación de caudal.
- Cuerpo empotrado incluido
- Ducha fija 220x220 mm. con rótula. (299.632.06).
- Soporte con toma pared (200.182.01).
- Ducha móvil anticalcárea (034.639.01).
- Flexo SATIN (91.34.609.15).



91.30.190

Cr 200.180.02

**N**

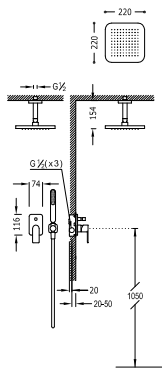

**Kit de ducha monomando empotrado**

- con cierre y regulación de caudal.
- Cuerpo empotrado incluido
- Ducha fija 220x220 mm. con rótula. (299.632.06).
- Soporte con toma pared (200.182.01).
- Ducha móvil anticalcárea (034.639.01).
- Flexo SATIN (91.34.609.15).



91.30.190

Cr 200.180.80

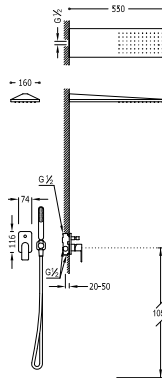

**Kit de ducha monomando empotrado**

- con cierre y regulación de caudal.
- Cuerpo empotrado incluido
- Rociador ducha INOX a pared 160x550 mm. (299.903.06).
- Soporte con toma pared (200.182.01).
- Ducha móvil anticalcárea (034.639.01).
- Flexo SATIN (91.34.609.15).



91.30.190

Cr 200.180.05



BAÑERAS DE REPISA

Ref.:

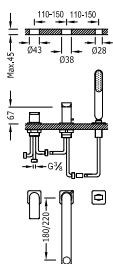

Monomando bañera de repisa

- con ducha anticálcara (034.639.01).
- Caudal: 3 bar ~ 16 l/m.
- Compatible con el kit depósito ref: 203.245.01.
- NOTA: ver longitud caño.

91.34.591 (180 mm.)  
Cr 200.162.03

91.34.591 (220 mm.)  
Cr 200.162.01



Kit depósito para bañeras de repisa

(para ref.: 062.161.03, 062.161.02, 200.162.03, 200.162.01, 081.161.04, 081.161.03, 203.161.02, 203.161.01).

Cr 203.245.01

📄 290



Válvula bañera con toma drenaje

Cr 1.34.445

📄 290

TERMOSTÁTICAS DE SUPERFICIE

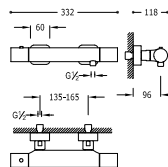

Ducha termostática

(Ducha de mano anticálcara (034.639.01) con soporte orientable y flexo SATIN (91.34.609.15)).

299.195.03  
Cr 200.164.01

299.195.03  
Cr 200.164.09

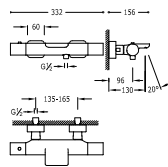

Bañera-ducha termostática

con cascada (Ducha de mano anticálcara (034.639.01) con soporte orientable y flexo SATIN (91.34.609)).

299.195.03  
Cr 200.174.01

299.195.03  
Cr 200.174.09



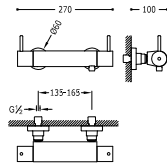

**Ducha termostática**

Ducha de mano anticalcárea (299.631.03) con soporte orientable y flexo SATIN (91.34.609.15). Indicado para personas con discapacidades físicas



299.195.09  
Cr | **090.264.01**



299.195.09  
Cr | **090.964.01**

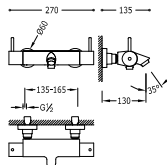

**Bañera-ducha termostática**

Ducha de mano anticalcárea (299.631.03) con soporte orientable y flexo SATIN (91.34.609.15). Indicado para personas con discapacidades físicas



299.195.09  
Cr | **090.274.01**



299.195.09  
Cr | **090.974.01**

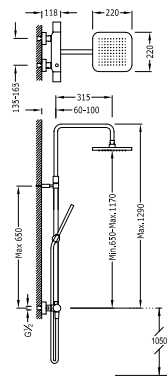

**Conjunto ducha termostática**

- Ducha fija 220x220 mm. con rótula. (299.632.06).
- Ducha móvil anticalcárea (034.639.01).
- Flexo SATIN (91.34.609.15).
- Barra telescópica.
- Inversor integrado en el regulador de caudal.



299.195.03  
Cr | **200.195.01**



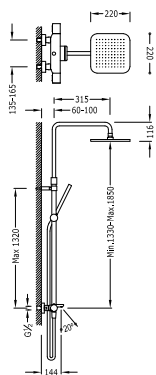

**Conjunto bañera-ducha termostática**

- Ducha fija 220x220 mm. con rótula. (299.632.06).
- Ducha móvil anticálrea (034.639.01).
- Flexo SATIN (91.34.609).
- Barra telescópica.



299.195.03

Cr 200.312.01

**LLAVES DE PASO**

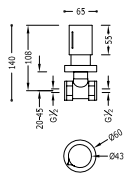

Llave de paso 1/2"

Cr 061.155.01

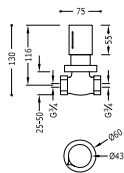

Llave de paso 3/4"

Cr 061.511.01









## CLASS-TRES



Lavabos

432



Bidé

436



Monomandos de superficie

437



Monomandos empotrados

438



Bañeras de repisa

439



Termostáticas de superficie

440



Accesorios

346

[www.tresgriferia.com](http://www.tresgriferia.com)



**RECAMBIOS**  
DE LOS ARTICULOS EN  
[www.tresgriferia.com](http://www.tresgriferia.com)



Monomando lavabo

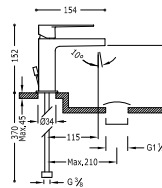

91.30.190  
**Cr 205.103.01**

91.30.190  
**Cr 205.103.01.D**

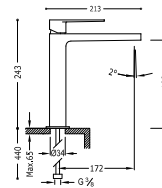

91.30.190  
**Cr 205.103.03**

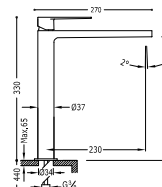

91.30.190  
**Cr 205.103.05**

Monomando lavabo  
caño de 34x9 mm.

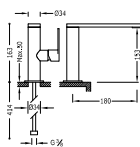

Cr 205.205.01

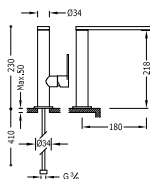

Cr 205.205.02

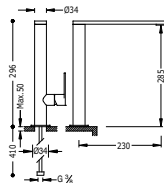

Cr 205.205.03



Grifo lavabo 1 agua o premezclada

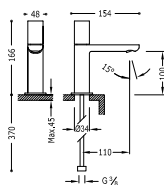

Cr 200.503.01

Lavabo temporizado 1 agua  
Cierre automático: 6 seg.

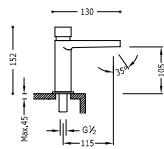

Cr 205.112.01

Lavabo temporizado mezclador

Cierre automático: 6 seg. NOTA: Incluye un grifo mezclador dos aguas con tubos flexibles (ref: 1.92.507.30).

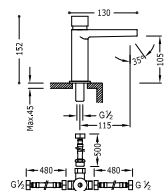

Cr 205.112.02



Monomando mural



91.30.190 (160 mm.)  
Cr 205.200.70

91.30.190 (210 mm.)  
Cr 205.200.71

91.30.190 (250 mm.)  
Cr 205.200.02

Monomando mural



91.30.190 (160 mm.)  
Cr 205.200.40

91.30.190 (210 mm.)  
Cr 205.200.41

91.30.190 (250 mm.)  
Cr 205.200.01

BIDÉ

Monomando bidé



91.30.190  
Cr 205.120.02

91.30.190  
Cr 205.120.02.D

91.30.190  
Cr 205.120.01

91.30.190  
Cr 205.120.01.D

Monomando bidé con duchita



91.34.592  
Cr 200.130.01

Ref:



**Monomando empotrar para bidé WC**

Soporte derecha o izquierda, cambiabile. Ducha de latón con racord limitador 5 l/m. Antigoteo y flexo SATIN. \* Opción para paredes de Pladur

91.34.591	
Cr	205.223.01
Cr	205.222.01*

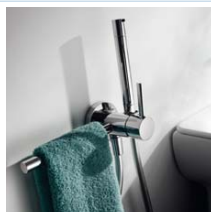

**Accesorio porta toallas**

180 mm. (para ref.: 1.34.122, 1.34.123, 1.81.122, 1.81.123, 205.222.01, 205.223.01). NOTA: Soporte derecha o izquierda, cambiabile.

Cr	034.124.01
----	------------

**MONOMANDOS DE SUPERFICIE**



**Monomando ducha**

Ducha de mano anticálcarea (299.631.08) con soporte orientable y flexo SATIN (91.34.609.15).

91.30.190	
Cr	205.168.01



**Monomando bañera-ducha**

con cascada. Ducha de mano anticálcarea (299.631.08) con soporte orientable y flexo SATIN (91.34.609).

91.30.190	
Cr	205.474.01



**Monomando ducha**

Ducha de mano anticálcarea (299.631.08) con soporte orientable y flexo SATIN (91.34.609.15).

91.07.190.05	
Cr	205.167.01



**Monomando bañera-ducha**

Ducha de mano anticálcarea (299.631.08) con soporte orientable y flexo SATIN (91.34.609).

91.30.190	
Cr	205.170.01

## MONOMANDOS EMPOTRADOS

Ref.:

### Monomando empotrar (1 vía)

cuerpo empotrado incluido



91.30.190  
Cr **205.177.01**

### Monomando empotrar (2 vías)

cuerpo empotrado incluido



91.30.190  
Cr **205.180.01**

### Kit de ducha monomando empotrado

- con cierre y regulación de caudal.
- Cuerpo empotrado incluido
  - Ducha fija 250x250 mm. con rótula. (1.34.138.26).
  - Soporte con toma pared (205.182.01).
  - Ducha móvil anticalcárea (299.631.08).
  - Flexo SATIN (91.34.609.15).



91.30.190  
Cr **205.180.02**

### Kit de ducha monomando empotrado

- con cierre y regulación de caudal.
- Cuerpo empotrado incluido
  - Ducha fija 250x250 mm. con rótula. (1.34.138.26).
  - Soporte con toma pared (205.182.01).
  - Ducha móvil anticalcárea (299.631.08).
  - Flexo SATIN (91.34.609.15).



91.30.190  
Cr **205.180.80**



Ref:



**Kit de ducha monomando empotrado**

- con cierre y regulación de caudal.
- Cuerpo empotrado incluido
- Rociador ducha INOX a pared 160x550 mm. (299.903.03).
- Soporte con toma pared (205.182.01).
- Ducha móvil anticalcárea (299.631.08).
- Flexo SATIN (91.34.609.15).



91.30.190  
Cr **205.180.03**

**BAÑERAS DE REPISA**

**Monomando bañera de repisa**

- con ducha anticalcárea (299.631.08).
- Caudal: 3 bar ~ 13 l/m.
- Compatible con el kit depósito ref: 200.245.01.
- NOTA: ver longitud caño.



91.30.190 (180 mm.)  
Cr **205.161.03**



91.30.190 (230 mm.)  
Cr **205.161.01**

**Kit depósito para bañeras de repisa**

(para ref.: 006.161.06, 006.161.04, 006.161.05,  
006.161.03, 205.161.03, 205.161.01).



Cr **200.245.01**



**Válvula bañera con toma drenaje**



Cr **1.34.445**



TERMOSTÁTICAS DE SUPERFICIE

Ref.:

**Ducha termostática**

(Ducha de mano anticálcarea (299.631.08) con soporte orientable y flexo SATIN (91.34.609.15)).



299.195.03  
Cr **061.162.01**



299.195.03  
Cr **205.164.01.9**



**Bañera-ducha termostática**

con cascada (Ducha de mano anticálcarea (299.631.08) con soporte orientable y flexo SATIN (91.34.609.15)).



299.195.03  
Cr **061.172.01**



299.195.03  
Cr **205.174.01.9**



**Ducha termostática**

Ducha de mano anticálcarea (299.631.03) con soporte orientable y flexo SATIN (91.34.609.15). Indicado para personas con discapacidades físicas



299.195.09  
Cr **090.264.01**



299.195.09  
Cr **090.964.01**



**Bañera-ducha termostática**

Ducha de mano anticálcarea (299.631.03) con soporte orientable y flexo SATIN (91.34.609.15). Indicado para personas con discapacidades físicas



299.195.09  
Cr **090.274.01**



299.195.09  
Cr **090.974.01**





**Conjunto ducha termostática**

- Ducha fija 250x250 mm. con rótula. (1.34.138.26).
- Ducha móvil anticalcárea (299.631.08).
- Flexo SATIN (91.34.609.15).
- Inversor integrado en el regulador de caudal.



299.195.03

Cr 205.395.01



**Conjunto ducha termostática**

- Ducha fija 250x250 mm. con rótula. (1.34.138.26).
- Ducha móvil anticalcárea (299.631.08).
- Flexo SATIN (91.34.609.15).
- Barra telescópica.
- Inversor integrado en el regulador de caudal.



299.195.03

Cr 205.385.01



**Conjunto bañera-ducha termostática**

- Ducha fija 250x250 mm. con rótula. (1.34.138.26).
- Ducha móvil anticalcárea (299.631.08).
- Flexo SATIN (91.34.609).
- Barra telescópica.



299.195.03

Cr 205.312.01





## LEX-TRES



Lavabos

444



Bidé

447



Monomandos de superficie

449



Monomandos empotrados

451



Bañeras de repisa

452



Termostáticas de superficie

453



Termostáticas empotradas

455



Accesorios

343

[www.tresgriferia.com](http://www.tresgriferia.com)



**RECAMBIOS**  
DE LOS ARTÍCULOS EN  
[www.tresgriferia.com](http://www.tresgriferia.com)

Monomando lavabo

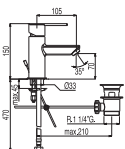

Cr 1.81.103



Cr 1.86.103

Monomando lavabo

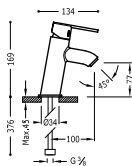

Cr 1.81.903



Cr 1.86.903

Monomando lavabo  
con alargadera

MEDIDAS ESPECIALES

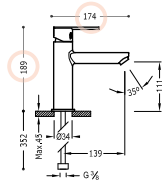

91.34.592

Cr | **1.81.203** |



91.34.592

Cr | **1.86.203** |

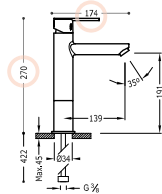

91.34.592

Cr | **1.81.217** |



91.34.592

Cr | **1.86.217** |

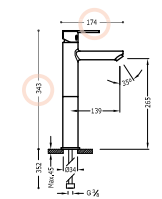

91.34.592

Cr | **1.81.207** |



91.34.592

Cr | **1.86.207** |

Monomando lavabo

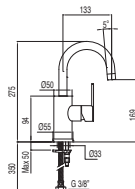

360° 91.34.592  
 Cr **1.81.703**

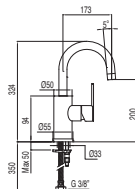

360° 91.34.592  
 Cr **1.81.403**

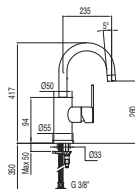

360° 91.34.592  
 Cr **1.81.303**

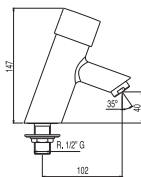

Lavabo temporizado 1 agua

Cierre automático: 6 seg. Caudal: 6,5 l/min.

91.12.284 6"  
 Cr **1.12.203**



Grifo lavabo 1 agua o premezclada

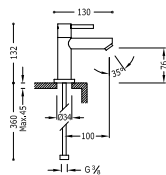

91.34.272.20  
 Cr **1.62.503**

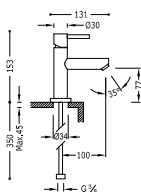

Monomando lavabo Ø 30 mm.

91.62.190  
 Cr **1.62.603**



Ref:

Monomando mural

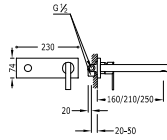

91.34.592 (160 mm.)

Cr | 081.200.01

91.34.592 (210 mm.)

Cr | 081.200.21

91.34.592 (250 mm.)

Cr | 1.81.200



Monomando mural  
con caño cascada

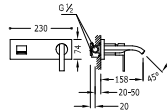

91.34.592.10

Cr | 081.260.10

**BIDÉ**

Monomando bidé

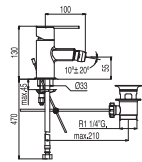

91.34.592 IA

Cr | 1.81.120

91.34.592 IA

Cr | 1.86.120

Monomando bidé

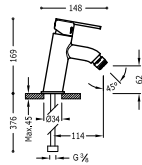

91.34.592

Cr | 1.81.920

91.34.592

Cr | 1.86.920

Monomando bidé

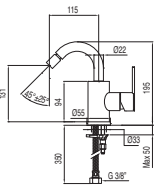

360° 91.34.592

Cr | 1.81.224





**Monomando ducha**

Ducha de mano masaje Ø 100 mm. (5 funciones) (1.34.748) con soporte orientable. Flexo SATIN (91.34.609.15).

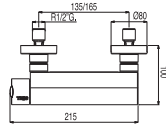

91.34.592  
Cr | **1.81.468**

**Monomando bañera-ducha**

Ducha de mano masaje Ø 100 mm. (5 funciones) (1.34.748) con soporte orientable. Flexo SATIN (91.34.609).

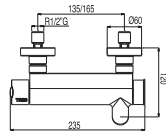

91.34.592  
Cr | **1.81.474**

**Conjunto ducha anticalcárea**

Ducha fija Ø 225 mm. con rótula. (299.632.01).  
Ducha móvil masaje Ø 100 mm. (5 funciones) (1.34.748).  
Flexo SATIN (91.34.609.15).

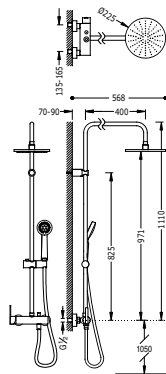

91.34.592  
Cr | **1.81.191**

**Conjunto ducha anticalcárea**

Ducha fija Ø 225 mm. con rótula. (299.632.01).  
Ducha móvil masaje Ø 100 mm. (5 funciones) (1.34.748).  
Flexo SATIN (91.34.609.15).  
Barra telescópica.

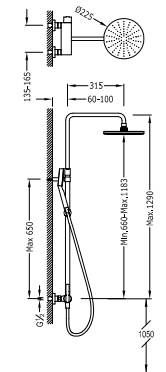

91.34.592  
Cr | **081.197.02**

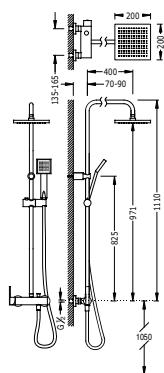

#### Conjunto ducha anticálcarea

- Ducha fija 200x200 mm. con rótula. (299.632.11).
- Ducha móvil anticálcarea (1.34.612).
- Flexo SATIN (91.34.609.15).



91.34.592

Cr 081.193.01

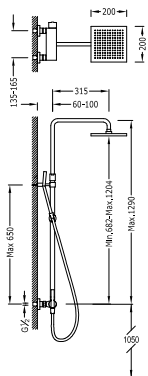

#### Conjunto ducha anticálcarea

- Ducha fija 200x200 mm. con rótula. (299.632.11).
- Ducha móvil anticálcarea (1.34.612).
- Flexo SATIN (91.34.609.15).
- Barra telescópica.



91.34.592

Cr 081.197.01

**Monomando empotrar (1 vía)**

cuerpo empotrado incluido



91.34.592

Cr 1.81.177.05

**Monomando empotrar (2 vías)**

cuerpo empotrado incluido



91.34.592

Cr 1.81.180.05



**Kit de ducha empotrado**

con cierre y regulación de caudal.

Cuerpo empotrado incluido

Ducha fija Ø 250 mm. con rótula. (1.34.137.26).

Soporte con toma pared (205.182.01).

Ducha móvil masaje Ø 100 mm. (5 funciones) (1.34.748).

Flexo SATIN (91.34.609.15).

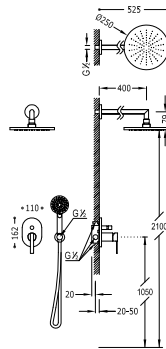

91.34.592

Cr 1.81.880.05

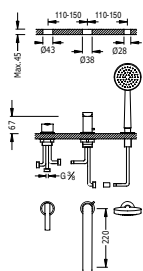
**Monomando bañera de repisa**

Ducha móvil masaje Ø 100 mm. (5 funciones) (1.34.748).

- Caudal: 3 bar - 16 l/m.
- Compatible con el kit depósito ref: 203.245.01.
- NOTA: ver longitud caño.

91.34.591 (180 mm.)  
Cr | **081.161.04**

91.34.591 (220 mm.)  
Cr | **081.161.03**

**Kit depósito para bañeras de repisa**

(para ref.: 062.161.03, 062.161.02, 200.162.03, 200.162.01, 081.161.04, 081.161.03, 203.161.02, 203.161.01).

Cr | **203.245.01**

📄 290

**Válvula bañera con toma drenaje**

Cr | **1.34.445**

📄 290

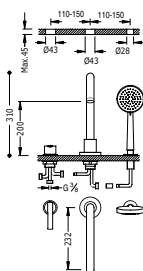
**Monomando bañera de repisa**

Ducha móvil masaje Ø 100 mm. (5 funciones) (1.34.748).

- Caudal: 3 bar - 14 l/m.
- Compatible con el kit depósito ref: 1.89.245.

91.34.591  
Cr | **081.150.01**

**Kit depósito para bañeras de repisa**

(para ref.: 081.150.01).

Cr | **1.89.245**

📄 290

**Válvula bañera con toma drenaje**

Cr | **1.34.445**

📄 290

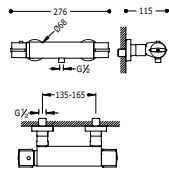

**Ducha termostática**

(Ducha de mano masaje Ø 100 mm. (5 funciones) (1.34.748) con soporte orientable. Flexo SATIN (91.34.609.15)).

91.81.161.10 IA IB

Cr **1.81.164**

91.81.161.10 IA IB

Cr **1.81.164,9**

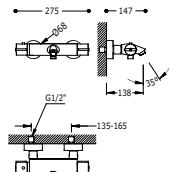

**Bañera-ducha termostática**

(Ducha de mano masaje Ø 100 mm. (5 funciones) (1.34.748) con soporte orientable. Flexo SATIN (91.34.609)).

91.81.161.10

Cr **1.81.174**

91.81.161.10

Cr **1.81.174,9**

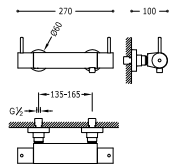

**Ducha termostática**

Ducha de mano anticálarea (299.631.03) con soporte orientable y flexo SATIN (91.34.609.15). Indicado para personas con discapacidades físicas

299.195.09

Cr **090.264.01**

299.195.09

Cr **090.964.01**

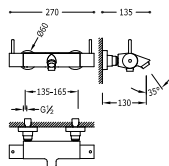

**Bañera-ducha termostática**

Ducha de mano anticálarea (299.631.03) con soporte orientable y flexo SATIN (91.34.609). Indicado para personas con discapacidades físicas

299.195.09

Cr **090.274.01**

299.195.09

Cr **090.974.01**



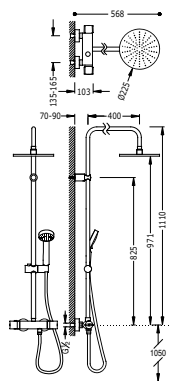

**Conjunto ducha termostática**

- Ducha fija Ø 225 mm. con rótula. (299.632.01).
- Ducha móvil masaje Ø 100 mm. (5 funciones) (1.34.748).
- Flexo SATIN (91.34.609.15).
- Inversor integrado en el regulador de caudal.

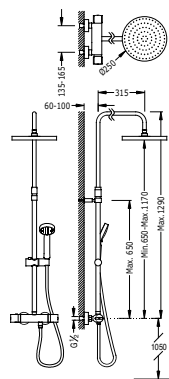

**Conjunto ducha termostática**

- Ducha fija Ø 250 mm. con rótula. (1.34.137.26).
- Ducha móvil masaje Ø 100 mm. (5 funciones) (1.34.748).
- Flexo SATIN (91.34.609.15).
- Barra telescópica.
- Inversor integrado en el regulador de caudal.

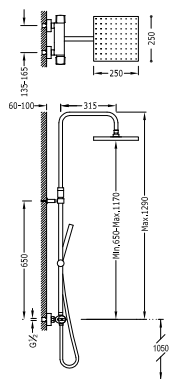

**Conjunto ducha termostática**

- Ducha fija 250x250 mm. con rótula. (1.34.138.26).
- Ducha móvil anticalcárea (006.639.01).
- Flexo SATIN (91.34.609.15).
- Barra telescópica.
- Inversor integrado en el regulador de caudal.





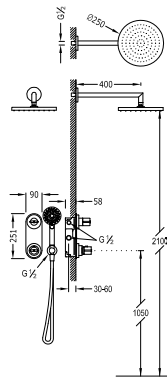

**Kit de ducha termostático empotrado**

con cierre y regulación de caudal (2 vías)

- Cuerpo empotrado termostático incluido
- Ducha fija Ø 250 mm. con rótula. (1.34.137.26).
- Soporte con toma pared (205.182.01).
- Ducha móvil masaje Ø 100 mm. (5 funciones) (1.34.748).
- Flexo SATIN (91.34.609.15).



299.250.55

Cr | 1.81.175







## ALPLUS



Lavabos

458



Bidé

461



Monomandos de superficie

463



Monomandos empotrados

464



Bañeras de repisa

465



Termostáticas de superficie

465



Termostáticas empotradas

467



Accesorios

343

[www.tresgriferia.com](http://www.tresgriferia.com)



**RECAMBIOS**  
DE LOS ARTÍCULOS EN  
[www.tresgriferia.com](http://www.tresgriferia.com)



Monomando lavabo  
con alargadera

MEDIDAS ESPECIALES

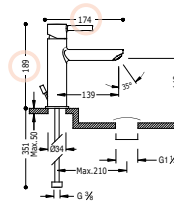

Cr | 203.203.01



Cr | 203.203.01.D

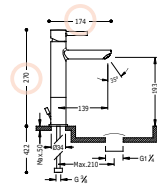

Cr | 203.217.01



Cr | 203.217.01.D

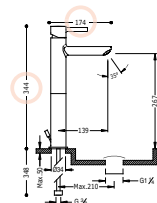

Monomando lavabo

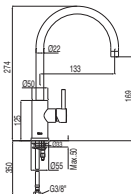

Cr 203.703.01

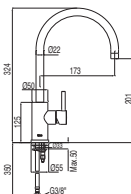

Cr 203.403.01

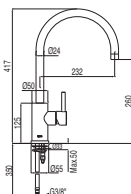

Cr 203.303.01



Lavabo temporizado 1 agua

Cierre automático: 6 seg. Caudal: 6,5 l/min.

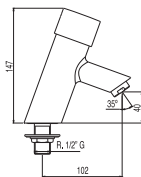

Cr 1.12.203

Grifo lavabo 1 agua o premezclada

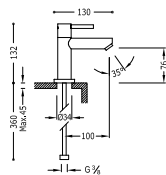

Cr 1.62.503

Monomando lavabo Ø 30 mm.

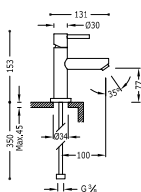

Cr 1.62.603

Ref:

Monomando mural

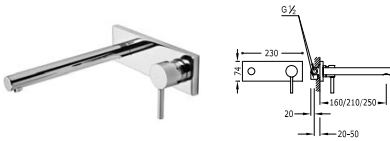

91.34.592 (160 mm.)  
Cr **203.210.01**

91.34.592 (210 mm.)  
Cr **203.200.02**

91.34.592 (250 mm.)  
Cr **203.200.01**

Monomando mural  
con caño cascada



91.34.592.10  
Cr **203.260.10**

**BIDÉ**

Monomando bidé

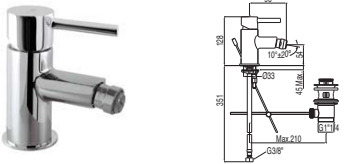

91.34.592 IA  
Cr **203.120.03**

91.34.592 IA  
Cr **203.120.03.D**

Monomando bidé

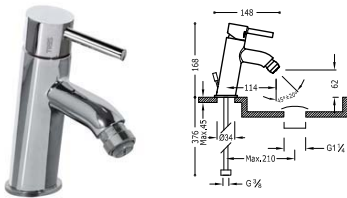

91.34.592  
Cr **203.920.01**

91.34.592  
Cr **203.920.01.D**

Monomando bidé

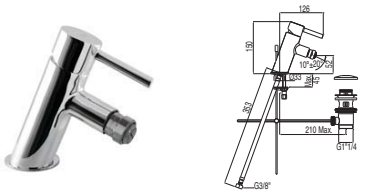

91.34.592 IB  
Cr **203.120.01**

91.34.592 IB  
Cr **203.120.01.D**

Monomando bidé

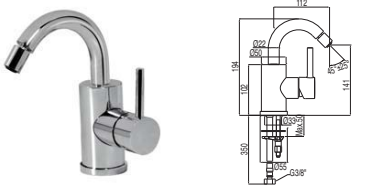

360° 91.34.592  
Cr **203.224.01**



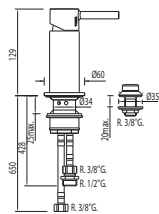

Monomando bidé con duchita



91.34.592

Cr 203.130.01

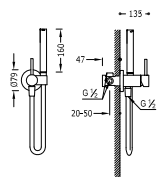

Monomando empotrar para bidé WC

Soporte derecha o izquierda, cambiable. Duchita de latón con record limitador 5 l/m. Antigoteo y flexo SATIN. \* Opción para paredes de Pladur



91.34.591

Cr 1.34.123

Cr 1.34.122\*



Accesorio porta toallas

180 mm. (para ref.: 1.34.122, 1.34.123, 1.81.122, 1.81.123, 205.222.01, 205.223.01). NOTA: Soporte derecha o izquierda, cambiable.

Cr 034.124.01

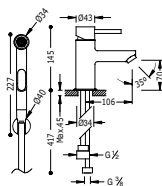

Monomando lavabo para bidé WC

Duchita con cierre y flexo SATIN



91.34.592.10

Cr 1.62.113





**Monomando ducha**

Ducha de mano anticalcárea (299.631.03) con soporte orientable y flexo SATIN (91.34.609.15).

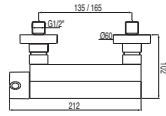

91.34.592  
Cr | 203.167.01

**Monomando bañera-ducha**

Ducha de mano anticalcárea (299.631.03) con soporte orientable y flexo SATIN (91.34.609).

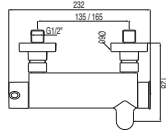

91.34.592  
Cr | 203.170.01

**Conjunto ducha anticalcárea**

Ducha fija Ø 225 mm. con rótula. (299.632.01).  
Ducha móvil anticalcárea (299.631.03).  
Flexo SATIN (91.34.609.15).

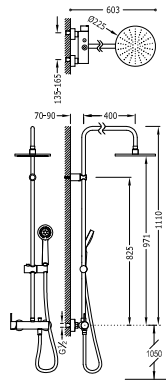

91.34.592  
Cr | 203.191.01

F

## MONOMANDOS EMPOTRADOS

Ref.:

## Monomando empotrar (1 vía)

cuerpo empotrado incluido

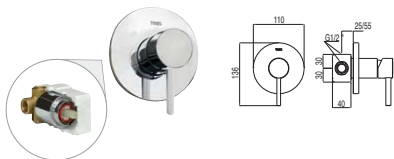

91.34.592

Cr | 203.177.01

## Monomando empotrar (2 vías)

cuerpo empotrado incluido



91.34.592

Cr | 203.180.01

## Kit de ducha empotrado

con cierre y regulación de caudal.

Cuerpo empotrado incluido

Ducha fija Ø 225 mm. con rótula. (299.632.01).

Soporte con toma pared (205.182.01).

Ducha móvil anticálcarea (299.631.03).

Flexo SATIN (91.34.609.15).

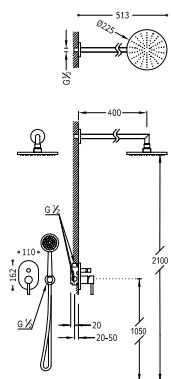

91.34.592

Cr | 203.180.02

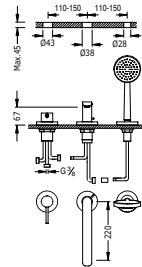

**Monomando bañera de repisa**

- Ducha móvil anticalcárea (299.631.03).
- Caudal: 3 bar – 16 l/m.
- Compatible con el kit depósito ref: 203.245.01.
- NOTA: ver longitud caño.

91.34.591 (180 mm.)  
Cr 203.161.02

91.34.591 (220 mm.)  
Cr 203.161.01



**Kit depósito para bañeras de repisa**

(para ref.: 062.161.03, 062.161.02, 200.162.03, 200.162.01, 081.161.04, 081.161.03, 203.161.02, 203.161.01).

Cr 203.245.01



290



**Válvula bañera con toma drenaje**

Cr 1.34.445



290

TERMOSTÁTICAS DE SUPERFICIE

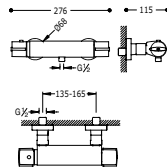

**Ducha termostática**

(Ducha de mano masaje Ø 100 mm. (5 funciones) (1.34.748) con soporte orientable. Flexo SATIN (91.34.609.15)).

91.81.161.10 IA IB NF  
Cr 1.81.164

91.81.161.10 IA IB NF  
Cr 1.81.164.9

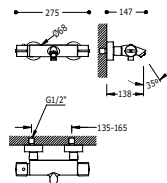

**Bañera-ducha termostática**

(Ducha de mano masaje Ø 100 mm. (5 funciones) (1.34.748) con soporte orientable. Flexo SATIN (91.34.609)).

91.81.161.10  
Cr 1.81.174

91.81.161.10  
Cr 1.81.174.9

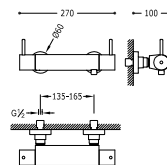

**Ducha termostática**

Ducha de mano anticalcárea (299.631.03) con soporte orientable y flexo SATIN (91.34.609.15). Indicado para personas con discapacidades físicas

299.195.09  
Cr 090.264.01

299.195.09  
Cr 090.964.01



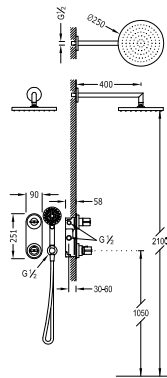

**Kit de ducha termostático empotrado**

- con cierre y regulación de caudal (2 vías)
- Cuerpo empotrado termostático incluido
- Ducha fija Ø 250 mm. con rótula. (1.34.137.26).
- Soporte con toma pared (205.182.01).
- Ducha móvil masaje Ø 100 mm. (5 funciones) (1.34.748).
- Flexo SATIN (91.34.609.15).



Cr | 1.81.175

F



TRES

45°

100 mm

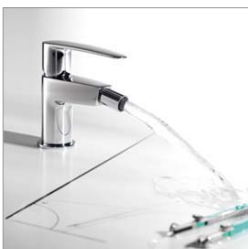

## FLAT-TRES



Lavabos

470



Bidé

470



Monomandos de superficie

470



Monomandos empotrados

471



Termostáticas de superficie

472



Accesorios

343

[www.tresgriferia.com](http://www.tresgriferia.com)



**RECAMBIOS**  
DE LOS ARTICULOS EN  
[www.tresgriferia.com](http://www.tresgriferia.com)

LAVABOS

Ref.: |

Monomando lavabo

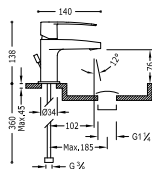

91.30.190  
Cr 204.103.01



91.30.190  
Cr 204.103.01.D

BIDÉ

Monomando bidé

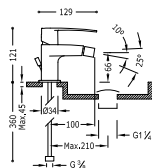

91.30.190  
Cr 204.120.01



91.30.190  
Cr 204.120.01.D

MONOMANDOS DE SUPERFICIE

Monomando ducha

Ducha de mano anticálcarea (1.34.617) con soporte orientable y flexo SATIN (91.34.609.15).

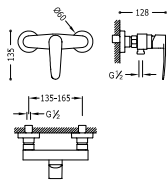

91.07.190.05 REQUADRA  
Cr 204.167.01

Monomando bañera-ducha

Ducha de mano anticálcarea (1.34.617) con soporte orientable y flexo SATIN (91.34.609).

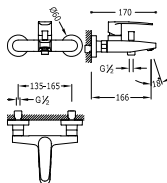

91.30.190 REQUADRA  
Cr 204.170.01





TERMOSTÁTICAS DE SUPERFICIE

Ref.:

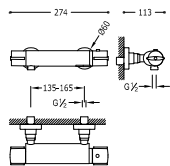

Ducha termostática

(Ducha de mano anticálcarea (1.34.617) con soporte orientable y flexo doble engatillado (91.34.828)).

299.195.08  
  
 Cr 204.196.01

299.195.08  
  
 Cr 204.196.03

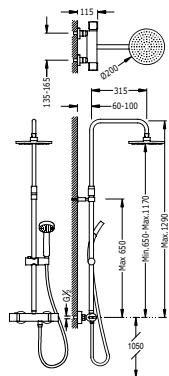

Conjunto ducha termostática

- Ducha fija Ø 200 mm. con rótula.
- Ducha anticálcarea Ø 80 mm. (1.34.617).
- Flexo SATIN (91.34.609.15).
- Barra telescópica.
- Inversor integrado en el regulador de caudal.

299.195.08  
  
 Cr 204.387.03

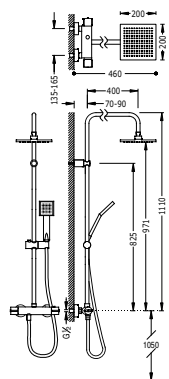

Conjunto ducha termostática

- Ducha fija 200x200 mm. con rótula.
- Ducha anticálcarea 80x80 mm. (1.34.612).
- Flexo SATIN (91.34.609.15).
- Inversor integrado en el regulador de caudal.

299.195.08  
  
 Cr 204.387.02



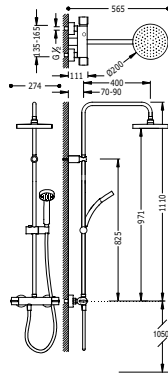

**Conjunto ducha termostática**

- Ducha fija Ø 200 mm. con rótula.
- Ducha anticálcarea Ø 80 mm. (1.34.617).
- Flexo SATIN (91.34.609.15).
- Inversor integrado en el regulador de caudal.



299.195.08

Cr 204.387.01

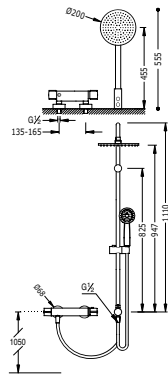

**Conjunto ducha termostática**

- Ducha fija Ø 200 mm. con rótula.
- Ducha anticálcarea Ø 80 mm. (1.34.617).
- Flexo SATIN (91.34.609.15).
- Inversor integrado en el regulador de caudal.



299.195.08

Cr 204.385.01





## K-TRES



Lavabos

476



Bidé

477



Monomandos de superficie

477



Monomandos empotrados

478



Bañeras de repisa

479



Termostáticas de superficie

480



Accesorios

343

[www.tresgriferia.com](http://www.tresgriferia.com)



**RECAMBIOS**  
DE LOS ARTICULOS EN  
[www.tresgriferia.com](http://www.tresgriferia.com)



Monomando bidé

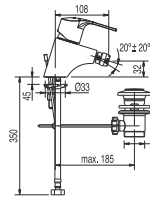

91.34.290  
Cr 1.69.120

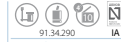

91.34.290  
Cr 1.69.120.DA

Monomando bidé con duchita

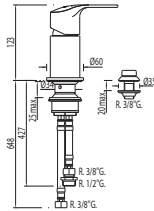

91.34.385.10  
Cr 069.130.01

MONOMANDOS DE SUPERFICIE

Monomando ducha

Ducha de mano anticalcárea con soporte orientable. Flexo doble engatillado

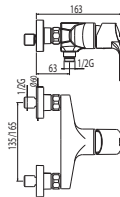

91.34.290  
Cr 069.167.02

Monomando bañera-ducha

Ducha de mano anticalcárea con soporte orientable. Flexo doble engatillado

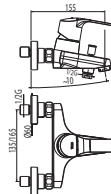

91.34.290  
Cr 069.170.02

## MONOMANDOS EMPOTRADOS

Ref.:

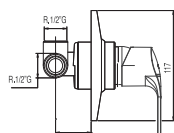

**Monomando empotrar (1 vía)**  
cuerpo empotrado incluido

91.34.290  
KLEBERADA  
Cr 069.177.12

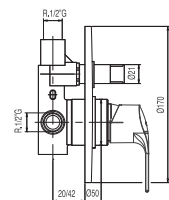

**Monomando empotrar (2 vías)**  
cuerpo empotrado incluido

91.34.290  
KLEBERADA  
Cr 069.180.12



**Kit de ducha monomando empotrado**  
con cierre y regulación de caudal.  
· Cuerpo empotrado incluido  
· Ducha fija Ø 225 mm. con rótula (299.632.01).

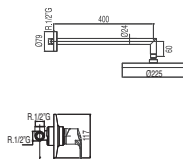

91.34.290  
KLEBERADA  
Cr 1.69.377



**Kit de ducha monomando empotrado**  
con cierre y regulación de caudal.  
· Cuerpo empotrado incluido  
· Ducha fija Ø 225 mm. con rótula. (299.632.01).  
· Soporte con toma pared (205.182.01).  
· Ducha móvil masaje Ø 110 mm. (5 funciones).  
· Flexo SATIN (91.34.609.15).

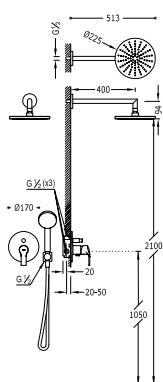

91.34.290  
KLEBERADA  
Cr 069.175.01



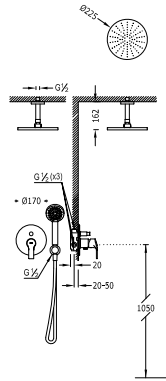

**Kit de ducha monomando empotrado**

- con cierre y regulación de caudal.
- Cuerpo empotrado incluido
- Ducha fija Ø 225 mm. con rótula. (299.632.01).
- Soporte con toma pared (205.182.01).
- Ducha móvil masaje Ø 110 mm. (5 funciones).
- Flexo SATIN (91.34.609.15).

91.34.290  
Cr **069.180.80**

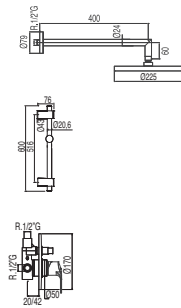

**Kit de ducha monomando empotrado**

- con cierre y regulación de caudal.
- Cuerpo empotrado incluido
- Ducha fija Ø 225 mm. con rótula. (299.632.01).
- Barra deslizante long. 516 mm.
- Codo toma pared (205.183.01).
- Ducha móvil masaje Ø 110 mm. (5 funciones).
- Flexo SATIN (91.34.609.15).

91.34.290  
Cr **1.69.980**

**BAÑERAS DE REPISA**

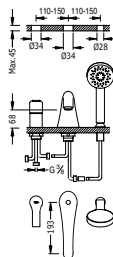

**Monomando bañera de repisa**

- Ducha móvil masaje Ø 110 mm. (5 funciones).
- Caudal: 3 bar – 15 l/m.

91.34.288  
Cr **1.69.145**

## TERMOSTÁTICAS DE SUPERFICIE

Ref.:

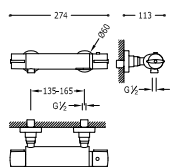

## Ducha termostática

(Ducha de mano anticálcarea (1.34.617) con soporte orientable y flexo doble engatillado (91.34.828)).

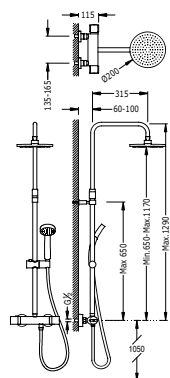

## Conjunto ducha termostática

- Ducha fija Ø 200 mm. con rótula.
- Ducha anticálcarea Ø 80 mm. (1.34.617).
- Flexo SATIN (91.34.609.15).
- Barra telescópica.
- Inversor integrado en el regulador de caudal.

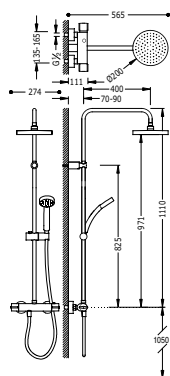

## Conjunto ducha termostática

- Ducha fija Ø 200 mm. con rótula.
- Ducha anticálcarea Ø 80 mm. (1.34.617).
- Flexo SATIN (91.34.609.15).
- Inversor integrado en el regulador de caudal.



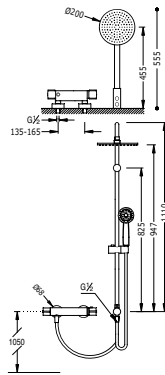

**Conjunto ducha termostática**

- Ducha fija Ø 200 mm. con rótula.
- Ducha anticalcárea Ø 80 mm. (1.34.617).
- Flexo SATIN (91.34.609.15).
- Inversor integrado en el regulador de caudal.



Cr | 204.385.01







## BM-TRES



Lavabos

484



Bidé

485



Monomandos de superficie

485



Monomandos empotrados

485



Bañeras de repisa

487



Accesorios

343

[www.tresgriferia.com](http://www.tresgriferia.com)



**RECAMBIOS**  
DE LOS ARTICULOS EN  
[www.tresgriferia.com](http://www.tresgriferia.com)



**BIDÉ**

Ref.: \_\_\_\_\_

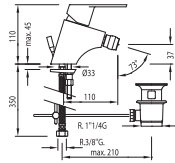

**Monomando bidé**

91.34.290  
Cr | **1.39.120** | IA

91.34.290  
Cr | **1.39.120.DA** | IA

**MONOMANDOS DE SUPERFICIE**

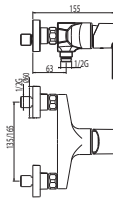

**Monomando ducha**

Ducha de mano anticalcárea con soporte orientable. Flexo doble engatillado

91.34.290  
Cr | **017.167.02** | IA

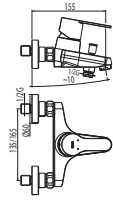

**Monomando bañera-ducha**

Ducha de mano anticalcárea con soporte orientable. Flexo doble engatillado

91.34.290  
Cr | **017.170.02** | IID/A

**MONOMANDOS EMPOTRADOS**

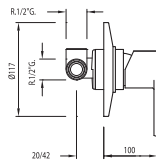

**Monomando empotrar (1 vía)**

cuerpo empotrado incluido

91.34.290  
Cr | **017.177.12** | REINARCA

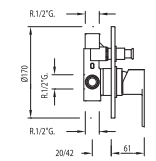

**Monomando empotrar (2 vías)**

cuerpo empotrado incluido

91.34.290  
Cr | **017.180.12** | REINARCA



**Kit de ducha monomando empotrado**

- con cierre y regulación de caudal.
- Cuerpo empotrado incluido.
- Ducha fija Ø 225 mm. con rótula. (299.632.01).

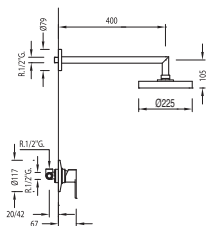

91.34.290

Cr 1.17.377



**Kit de ducha monomando empotrado**

- con cierre y regulación de caudal.
- Cuerpo empotrado incluido.
- Ducha fija Ø 225 mm. con rótula. (299.632.01).
- Soporte con toma pared (205.182.01).
- Ducha anticalcárea Ø 100 mm.
- Flexo SATIN (91.34.609.15).

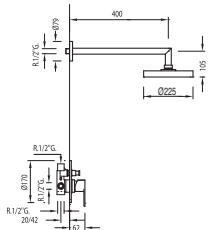

91.34.290

Cr 1.17.175

**N**



**Kit de ducha monomando empotrado**

- con cierre y regulación de caudal.
- Cuerpo empotrado incluido.
- Ducha fija Ø 225 mm. con rótula. (299.632.01).
- Soporte con toma pared (205.182.01).
- Ducha anticalcárea Ø 100 mm.
- Flexo SATIN (91.34.609.15).

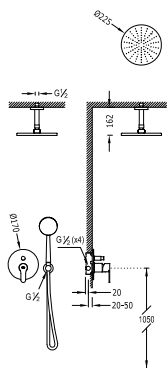

91.34.290

Cr 017.180.80



Ref:



**Kit de ducha monomando empotrado**

- con cierre y regulación de caudal.
- Cuerpo empotrado incluido
- Ducha fija Ø 225 mm. con rótula. (299.632.01).
- Barra deslizante long. 516 mm.
- Codo toma pared (205.183.01).
- Ducha anticalcárea Ø 100 mm.
- Flexo SATIN (91.34.609.15).

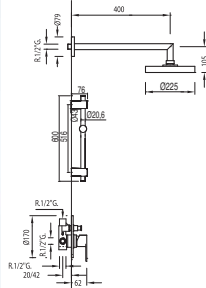

91.34.290  
Cr **1.17.980**



**BAÑERAS DE REPISA**

Ref:



**Monomando bañera de repisa**

- Ducha anticalcárea.
- Caudal: 3 bar - 15 l/m.

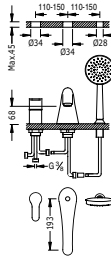

91.34.288  
Cr **1.17.145**



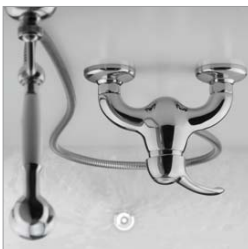

## MONOCLASIC 1900



Lavabos

490



Bidé

490



Monomandos de superficie

491



Monomandos empotrados

491



Bañeras de repisa

492



Termostáticas de superficie

493



Accesorios

350

[www.tresgriferia.com](http://www.tresgriferia.com)



**RECAMBIOS**  
DE LOS ARTICULOS EN  
[www.tresgriferia.com](http://www.tresgriferia.com)

LAVABOS

Ref.:

Monomando lavabo

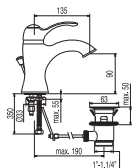

		91.34.290
Cr	1.42.103.02	
Lv	5.42.103.02.01	

		91.34.290
Cr	1.47.103.02	
Lv	5.47.103.02.01	

BIDÉ

Monomando bidé

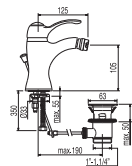

		91.34.290
Cr	1.42.120.02	
Lv	5.42.120.02.01	

		91.34.290
Cr	1.47.120.02	
Lv	5.47.120.02.01	

**MONOMANDOS DE SUPERFICIE**

Ref:

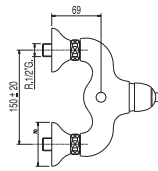

**Monomando ducha**

Ducha de mano anticalcárea con soporte orientable. Flexo doble engatillado

	91.34.290		RELEGADA
Cr	1.42.167.02		
Lv	5.42.167.02.01		

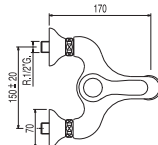

**Monomando bañera**

Ducha de mano anticalcárea con soporte orientable. Flexo doble engatillado

	91.34.290		RELEGADA
Cr	1.42.170.02		
Lv	5.42.170.02.01		

**MONOMANDOS EMPOTRADOS**

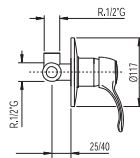

**Monomando empotrar (1 vía)**

cuerpo empotrado incluido

	91.34.290		RELEGADA
Cr	042.177.12		

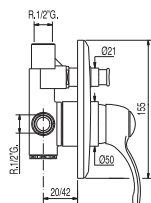

**Monomando empotrar (2 vías)**

cuerpo empotrado incluido

	91.34.290		RELEGADA
Cr	042.180.12		



**Ducha MONOCLASIC termostática**

Ducha de mano anticalcárea con soporte orientable. Flexo doble engatillado

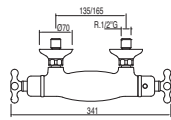

299.195.10  
299.195.10.LV

Cr	032.164.09
Lv	032.164.09.LV

**Bañera-ducha MONOCLASIC termostática**

Ducha de mano anticalcárea con soporte orientable. Flexo doble engatillado

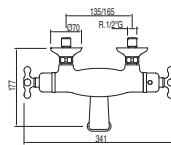

299.195.10  
299.195.10.LV

Cr	032.174.09
Lv	032.174.09.LV

**Bañera-ducha MONOCLASIC termostática con soporte**

Ducha móvil anticalcárea y flexo doble engatillado

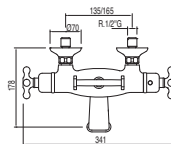

299.195.10  
299.195.10.LV

Cr	032.176.09
Lv	032.176.09.LV

**Tomas de agua a suelo de bañera**

2 unidades con soporte ducha giratorio

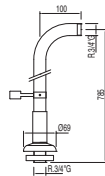

Cr	1.24.194
Lv	024.194.01.LV

**Codo adaptador baño-ducha**

2 unidades con silenciador

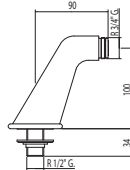

Cr	024.871.01
Lv	024.871.01.LV

**Kit de ducha termostático MONOCLASIC**

- Barra deslizante RETRO long. 550 mm.
- Ducha móvil anticalcárea.
- Flexo doble engatillado.

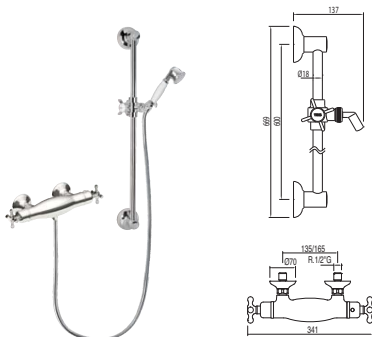

299.195.10  
299.195.10.LV

Cr	032.164.02
Lv	032.164.02.LV



**Conjunto ducha MONOCLASIC termostática**

- Ducha fija Ø 310 mm. con rótula.
- Ducha móvil anticalcárea.
- Flexo doble engatillado.
- Barra telescópica.

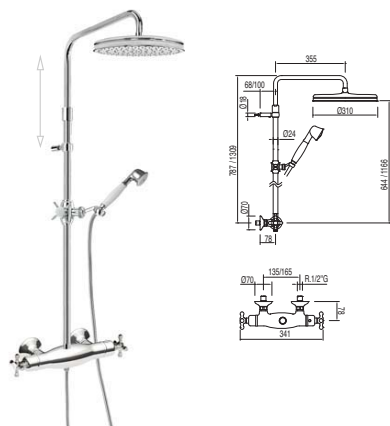

299.195.10  
299.195.10.LV

Cr	032.195.02
Lv	032.195.02.LV



**Conjunto ducha MONOCLASIC termostática**

- Ducha fija Ø 310 mm. con rótula. (299.337.03).
- Ducha móvil anticalcárea (91.34.824).
- Flexo doble engatillado (91.34.828).

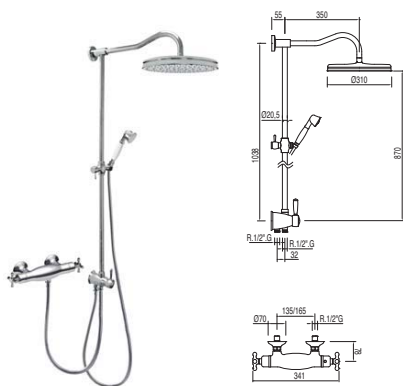

299.195.10

Cr	032.195.01
----	------------





**Conjunto bañera-ducha MONOCLASIC termostática**

- Ducha fija Ø 310 mm. con rótula. (299.337.03).
- Ducha móvil anticalcárea (91.34.824).
- Flexo doble engatillado (91.34.828).

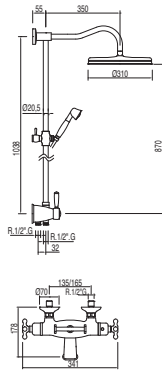

299.195.10

Cr **032.198.01**







## CLASIC-TRES



Lavabos

498



Bidé

499



Bimandos de superficie

499



Bañeras de repisa

501



Termostáticas de superficie

501



Accesorios

350

[www.tresgriferia.com](http://www.tresgriferia.com)



**RECAMBIOS**  
DE LOS ARTICULOS EN  
[www.tresgriferia.com](http://www.tresgriferia.com)

Bimando lavabo

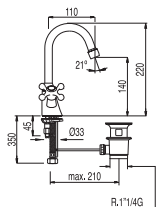

Cr	1.32.104
Lv	5.32.104.01



Cr	1.37.104
Lv	5.37.104.01

Grifo lavabo de 1/2"

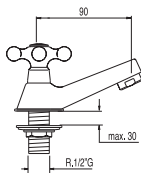

Cr	1.32.100.F
----	------------



Cr	1.32.100.C
----	------------

Bimando lavabo

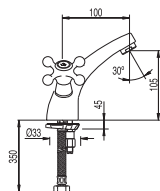

Cr	1.32.103
----	----------



Cr	1.37.103
----	----------

Batería lavabo

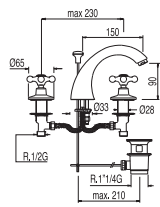

Cr	1.37.106
Lv	5.37.106.01

Grifo lateral

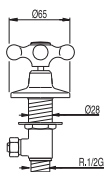

Cr	1.32.510.F
----	------------



Cr	1.32.510.C
----	------------

**BIDÉ**

Ref.: |

**Bimando bidé**

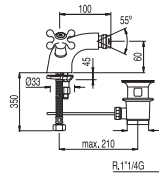

Cr | 1.32.120 |



Cr | 1.37.120 |

**Bimando bidé**

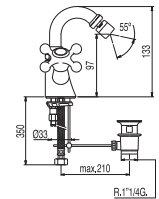

Cr | 1.32.124 |

Lv | 5.32.124.01 |



Cr | 1.37.124 |

Lv | 5.37.124.01 |

**Batería bidé con duchita**

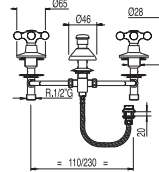

Cr | 1.32.130 |

**Grifo bidé de 1/2"**

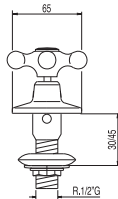

Cr | 1.32.125.F |

Lv | 5.32.125.01.F |



Cr | 1.32.125.C |

Lv | 5.32.125.01.C |

**BIMANDO DE SUPERFICIE**

**Grupo ducha**

Ducha de mano anticálcaea con soporte orientable. Flexo doble engatillado

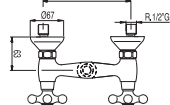

Cr | 1.32.768 |

Lv | 5.32.765.01 |

**Grupo baño-ducha**

Ducha de mano anticálcaea con soporte orientable. Flexo doble engatillado

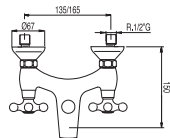

Cr | 1.32.774 |

Lv | 5.32.771.01 |

Cr = Cromo Lv = Latón viejo

F = Lado frío

C = Lado caliente

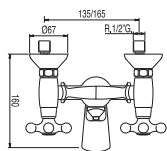

**Grupo baño-ducha**

Ducha anticalcárea. Flexo doble engatillado

	REGULARIA
Cr	1.32.176
Lv	5.32.176.01

**ELEMENTOS DE DUCHA**

**Barra deslizante RETRO**

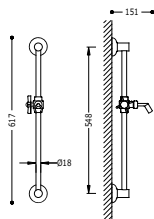

Cr	1.34.732
Lv	5.34.732.01
Ac	5.34.732.03

**Barra telescópica CLASIC**

Ducha fija Ø 310 mm. con rótula. Con distribuidor

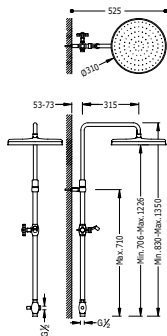

Cr	024.213.01
Lv	024.213.01.LV

BAÑERAS DE REPISA

Ref.:

Batería bañera de repisa

con inversor.  
· Caudal: 3 bar – 12 l/m.

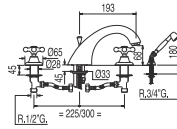

Cr	1.32.145
Lv	5.32.145.01



Kit depósito para bañeras de repisa  
(para ref.: 1.63.145, 1.32.145, 1.24.146).

Cr 1.34.345



Válvula bañera con toma drenaje

Cr 1.34.445



TERMOSTÁTICAS DE SUPERFICIE

Ducha CLASIC termostática

Ducha de mano anticálcaea con soporte orientable. Flexo doble engatillado

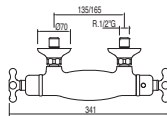

299.195.10	299.195.10LV
Cr	032.164.09
Lv	032.164.09.LV

Bañera-ducha CLASIC termostática

Ducha de mano anticálcaea con soporte orientable. Flexo doble engatillado

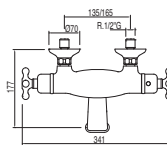

299.195.10	299.195.10LV
Cr	032.174.09
Lv	032.174.09.LV

Bañera-ducha CLASIC termostática con soporte

Ducha móvil anticálcaea y flexo doble engatillado

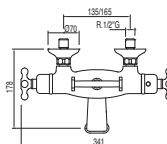

299.195.10	299.195.10LV
Cr	032.176.09
Lv	032.176.09.LV

Cr = Cromo Lv = Latón viejo

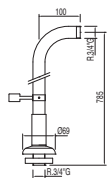

**Tomas de agua a suelo de bañera**  
2 unidades con soporte ducha giratorio

Cr	1.24.194
Lv	024.194.01.LV

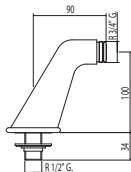

**Codo adaptador baño-ducha**  
2 unidades con silenciador

Cr	024.871.01
Lv	024.871.01.LV

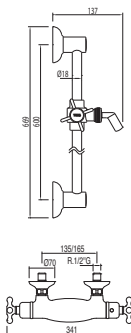

**Kit de ducha termostático CLASIC**  
- Barra deslizante RETRO long. 550 mm.  
- Ducha móvil anticalcárea.  
- Flexo doble engatillado.

	299.195.10 299.195.10.LV	 REGADORA
Cr	032.164.02	
Lv	032.164.02.LV	

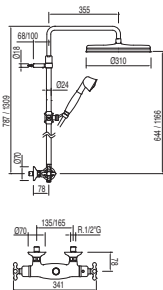

**Conjunto ducha CLASIC termostática**  
- Ducha fija Ø 310 mm. con rótula.  
- Ducha móvil anticalcárea.  
- Flexo doble engatillado.  
- Barra telescópica.

	299.195.10 299.195.10.LV	 REGADORA
Cr	032.195.02	
Lv	032.195.02.LV	





**Conjunto ducha CLASIC termostática**

- Ducha fija Ø 310 mm. con rótula. (299.337.03).
- Ducha móvil anticalcárea (91.34.824).
- Flexo doble engatillado (91.34.828).

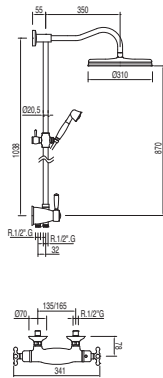

**Conjunto bañera-ducha CLASIC termostática**

- Ducha fija Ø 310 mm. con rótula. (299.337.03).
- Ducha móvil anticalcárea (91.34.824).
- Flexo doble engatillado (91.34.828).

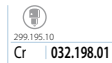
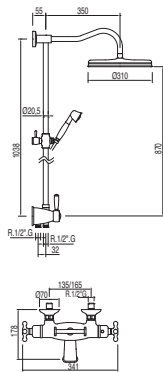

**LLAVES DE PASO**

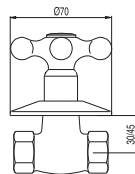

**Llave de paso roscar de 1/2"**



Cr 1.33.155.F  
Lv 5.33.155.01.F



Cr 1.33.155.C  
Lv 5.33.155.01.C

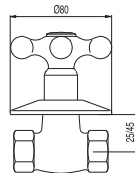

**Llave de paso roscar de 3/4"**



Cr 1.33.157.F  
Lv 5.33.157.01.F



Cr 1.33.157.C  
Lv 5.33.157.01.C





## RETRO-TRES



Lavabos

506



Bidé

508



Bimandos de superficie

508



Monomandos empotrados

510



Bañeras de repisa

511



Termostáticas de superficie

512



Accesorios

350

[www.tresgriferia.com](http://www.tresgriferia.com)



**RECAMBIOS**  
DE LOS ARTÍCULOS EN  
[www.tresgriferia.com](http://www.tresgriferia.com)

BIMANDO LAVABOS

Ref.:

Bimando lavabo

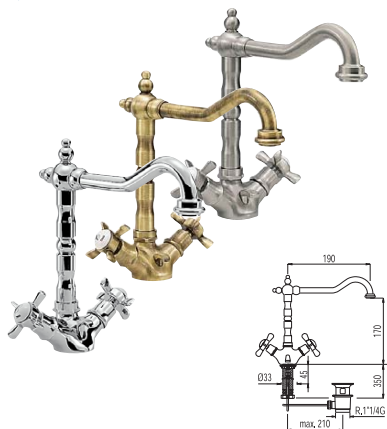

		360°
Cr	1.29.104.61	
Lv	5.29.104.01.61	
Ac	5.29.104.03.61	

Monomando lavabo

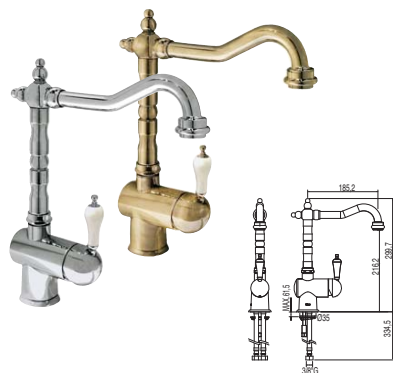

		360° 91.34.288
Cr	024.203.01	
Lv	024.203.01.LV	



Bimando lavabo

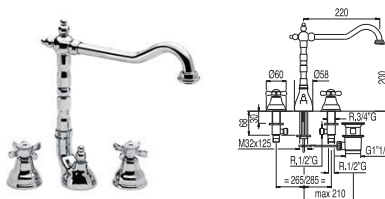

		
Cr	1.29.103.61	
Lv	5.29.103.01.61	
Ac	5.29.103.03.61	

Batería lavabo



		360°
Cr	1.29.105.61	
Lv	5.29.105.01.61	

Ref:

Batería lavabo

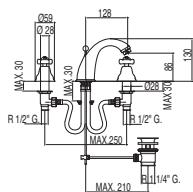

Cr	1.29.106	
Lv	5.29.106.01	

Batería lavabo mural

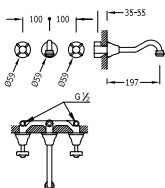

Cr	1.24.151	
Lv	5.24.151.01	

Grifo lateral batería lavabo

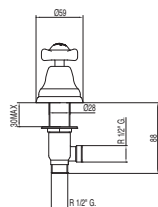

Cr	1.24.125.F	
Lv	5.24.125.01.F	



Cr	1.24.125.C	
Lv	5.24.125.01.C	

Grifo mando lateral

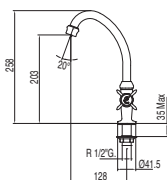

Cr	1.24.306	
----	----------	--

Grifo lavabo 1 agua o premezclada

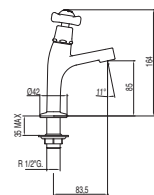

Cr	1.24.503	
----	----------	--



BIDÉ

Ref.:

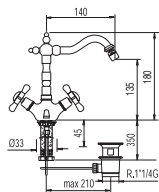

Bimando bidé



Cr	1.29.124.61
Lv	5.29.124.01.61
Ac	5.29.124.03.61

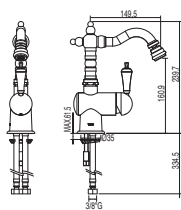

Monomando bidé



Cr	024.220.01
Lv	024.220.01.LV

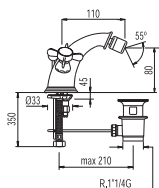

Bimando bidé



Cr	1.29.120.61
Lv	5.29.120.01.61
Ac	5.29.120.03.61

BIMANDO DE SUPERFICIE

Grupo ducha

Excéntricas con silenciador. Ducha de mano anticalcárea con soporte orientable. Flexo doble engatillado

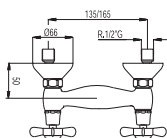

Cr	1.24.167.61
Lv	5.24.167.01.61
Ac	5.24.167.03.61

Grupo baño-ducha

Excéntricas con silenciador. Ducha móvil anticalcárea y flexo doble engatillado.

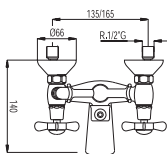

Cr	1.24.170.61
Lv	5.24.170.01.61
Ac	5.24.170.03.61

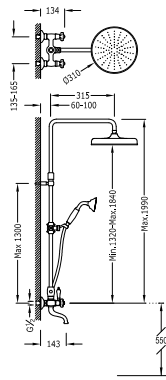

**Conjunto bañera-ducha RETRO**

- Ducha fija Ø 310 mm. con rótula.
- Ducha móvil anticalcárea.
- Barra telescópica.



Cr	1.24.290.7	
Lv	5.24.290.7.01	

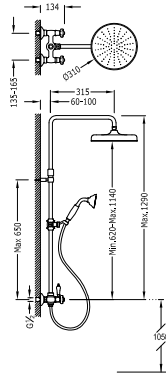

**Conjunto ducha RETRO**

- Ducha fija Ø 310 mm. con rótula.
- Ducha móvil anticalcárea.
- Barra telescópica.



Cr	1.24.280.7	
Lv	5.24.280.7.01	

**ELEMENTOS DE DUCHA**

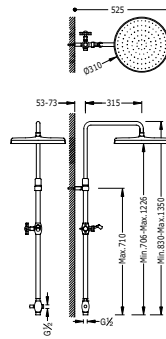

**Barra telescópica RETRO**

Ducha fija Ø 310 mm. con rótula. Con distribuidor

Cr	024.213.01	
Lv	024.213.01.LV	

Barra deslizante RETRO

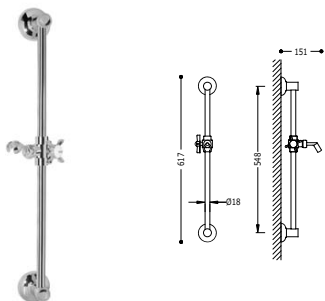

Cr	1.34.732	
Lv	5.34.732.01	

Ducha anticalcárea RETRO



Cr	1.24.824	
Lv	5.24.824.01	

Caño pared RETRO



Cr	1.24.173	
Lv	5.24.173.01	

MONOMANDOS EMPOTRADOS

Monomando empotrar (1 vía)  
cuerpo empotrado incluido



Cr	024.177.12	

Monomando empotrar (2 vías)  
cuerpo empotrado incluido

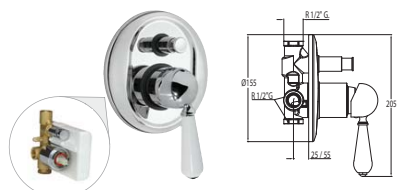

Cr	024.180.12	





TERMOSTÁTICAS DE SUPERFICIE

Ref.:

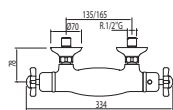

**Ducha RETRO termostática**

Ducha de mano anticalcárea con soporte orientable. Flexo doble engatillado.



Cr **024.164.09**  
Lv **024.164.09.LV**

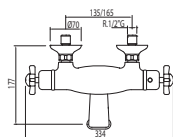

**Bañera- ducha RETRO termostática**

Ducha de mano anticalcárea con soporte orientable. Flexo doble engatillado.



Cr **024.174.09**  
Lv **024.174.09.LV**

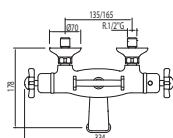

**Bañera- ducha RETRO termostática con soporte**

Ducha móvil anticalcárea y flexo doble engatillado.



Cr **024.176.09**  
Lv **024.176.09.LV**

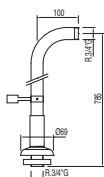

**Tomas de agua a suelo de bañera**

2 unidades con soporte ducha giratorio

Cr **1.24.194**  
Lv **024.194.01.LV**

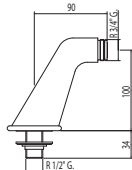

**Codo adaptador baño- ducha**

2 unidades con silenciador

Cr **024.871.01**  
Lv **024.871.01.LV**

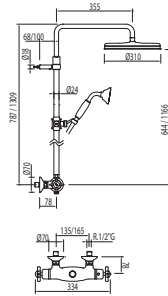

**Conjunto ducha RETRO termostática**

- Ducha fija Ø 310 mm. con rótula.
- Ducha móvil anticálcarea.
- Flexo doble engatillado.
- Barra telescópica



	299.195.11 299.195.11.LV	
Cr	<b>024.195.02</b>	
Lv	<b>024.195.02.LV</b>	

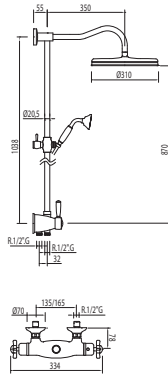

**Conjunto ducha RETRO termostática**

- Ducha fija Ø 310 mm. con rótula. (299.337.03).
- Ducha móvil anticálcarea (1.24.824).
- Flexo doble engatillado (91.34.828).



	299.195.11	
Cr	<b>024.195.01</b>	

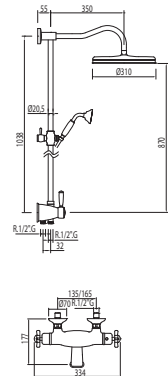

**Conjunto bañera-ducha RETRO termostática**

- Ducha fija Ø 310 mm. con rótula. (299.337.03).
- Ducha móvil anticálcarea (1.24.824).
- Flexo doble engatillado (91.34.828).



	299.195.11	
Cr	<b>024.198.01</b>	



**VARIOS**

Ref.: \_\_\_\_\_

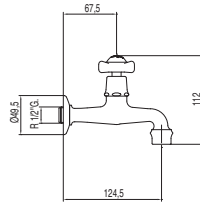

**Grifo office**

Cr 1.24.520

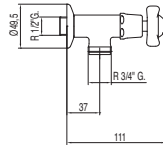

**Grifo lavadora**  
salida rosca de 3/4"

Cr 1.24.500

**LLAVES DE PASO**

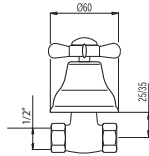

**Llave de paso**  
1/2"



Cr 1.24.155.61.F  
Lv 5.24.155.01.61.F



Cr 1.24.155.61.C  
Lv 5.24.155.01.61.C

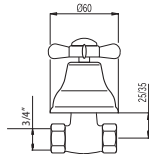

**Llave de paso**  
3/4"



Cr 1.24.157.61.F  
Lv 5.24.157.01.61.F



Cr 1.24.157.61.C  
Lv 5.24.157.01.61.C



TRES



## COCINA



Monomando

520



Con caño extraíble

528



Abatible

532



Electrónica

533



Para tratamiento de agua

534



Industrial

536



Mural

538



Bimando

541



[www.tresgriferia.com](http://www.tresgriferia.com)



**RECAMBIOS**  
DE LOS ARTICULOS EN  
[www.tresgriferia.com](http://www.tresgriferia.com)





## Características generales

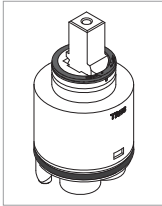

**Cartucho cerámico Patentado®**  
El cartucho TRES evita el desgaste de los discos con el grifo cerrado, alargando la vida útil del mismo.

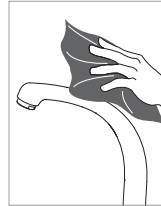

**Cromado para toda la vida**  
El cromado TRES-MICRON® es duradero y fácil de limpiar.

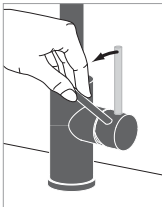

**Maneta con rotación frontal**  
Evita que la maneta choque contra la pared.

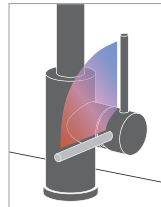

**Ahorro energético con Cold-Tres®**  
El grifo se abre siempre en agua fría, evitando el encendido innecesario del calentador.

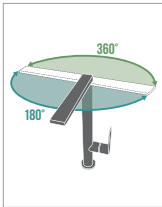

**Caño giratorio**  
Según modelos, caños de giro limitado a 180° o bien completa libertad de movimiento a 360°.

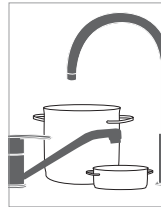

**Alturas de confort**  
Los caños con diferentes alturas son ideales para encimeras especiales.

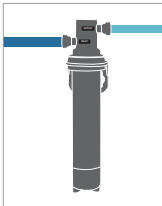

**Filtro anticloro**  
Asegura un índice bajo en cloro, eliminando el mal sabor de agua pero respetando las propiedades minerales del agua de red.

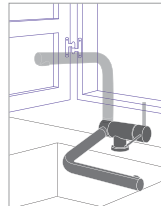

**Abatible**  
Ideal para instalaciones frente a ventanas o armarios. Esta grifería permite rotar y abatir cuando sea necesario.



**Caño o ducha retráctil**  
Incrementa el radio de acción y puede ofrecer distintos tipos de chorro.

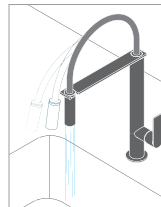

**Caño extraíble**  
Permiten ampliar la zona de trabajo de 50 a 70 cm.



COCINA MONOMANDO

Ref:

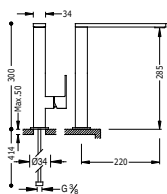

Monomando fregadero vertical CUADRO-TRES  
caño de 34x10 mm.

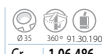

Cr 1.06.486

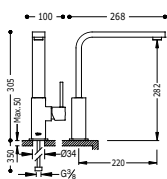

Monomando fregadero vertical CUADRO-TRES  
caño de 35x15 mm.



Cr 1.30.496

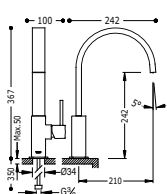

Monomando fregadero vertical CUADRO-TRES  
caño 35x15 mm. con aireador rectangular oculto



Cr 1.30.498

Ref:

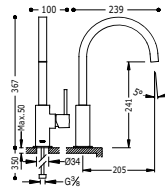

Monomando fregadero vertical CUADRO-TRES  
caño de 22x22 mm.



Cr | 1.30.497

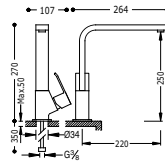

Monomando fregadero vertical CUADRO-TRES  
caño de 35x15 mm.



Cr | 1.06.440

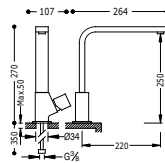

Monomando fregadero vertical CUADRO-TRES  
caño de 35x15 mm.



Cr | 1.07.440

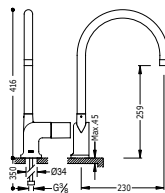

Monomando fregadero vertical



Cr | 1.87.440

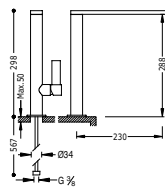

Monomando fregadero vertical CLASS-TRES  
caño de 34x9 mm.



Cr | 205.486.01

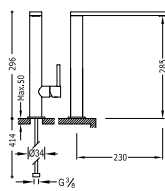

Monomando fregadero vertical MAX-TRES  
caño de 34x9 mm.



Cr | 062.488.01



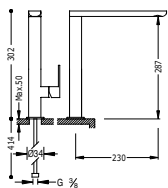

Monomando fregadero vertical LOFT-TRES  
caño de 34x15 mm.



Ø 35 360° 91.30.190

Cr 200.440.01

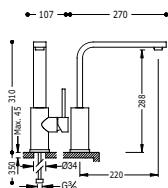

Monomando fregadero vertical  
caño de 35x15 mm



Ø 35 360° 91.34.592

Cr 1.62.435

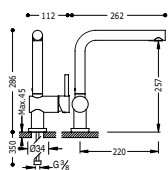

Monomando fregadero vertical



Ø 35 360° 91.34.288

Cr 1.30.336

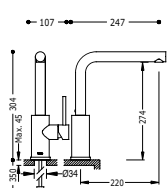

Monomando fregadero vertical MAX-TRES



Ø 35 360° 91.34.592

Cr 1.62.436

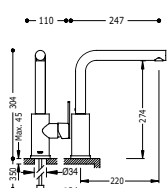

Monomando fregadero vertical LEX-TRES



Ø 35 360° 91.34.592

Cr 1.81.436

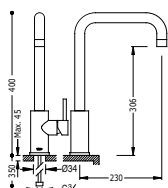

Monomando fregadero vertical MAX-TRES



Ø 35 360° 91.34.592

Cr 1.62.541

Ref:

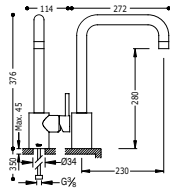

Monomando fregadero vertical MAX-TRES

Ø 33 360° 91.34.290  
**Cr 1.62.441**

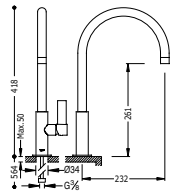

Monomando fregadero vertical CLASS-TRES



Ø 34 360° 91.30.190  
**Cr 205.440.01**

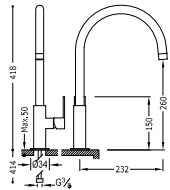

Monomando fregadero vertical LOFT-TRES



Ø 34 360° 91.30.190  
**Cr 200.440.02**

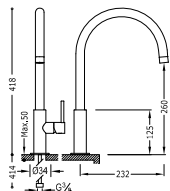

Monomando fregadero vertical MAX-TRES



Ø 34 360° 91.30.190  
**Cr 062.542.01**

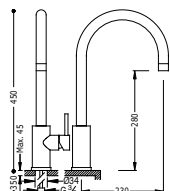

Monomando fregadero vertical MAX-TRES



Ø 35 360° 91.34.592  
**Cr 1.62.540**

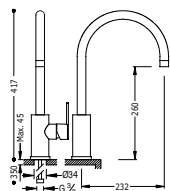

Monomando fregadero vertical LEX-TRES



Ø 35 360° 91.34.592  
**Cr 1.81.540**

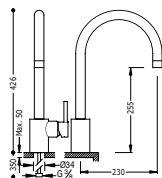

Monomando fregadero vertical MAX-TRES



Cr 1.62.440

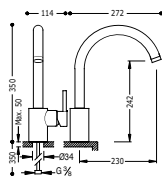

Monomando fregadero vertical MAX-TRES



Cr 1.62.442

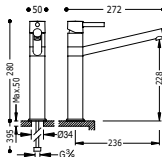

Monomando fregadero vertical ALPLUS  
caño largo



Cr 1.83.333

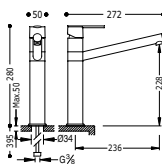

Monomando fregadero vertical LEX-TRES  
caño largo



Cr 1.81.333

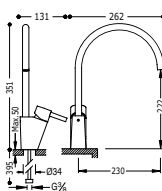

Monomando fregadero vertical ALPLUS



Cr 1.83.341

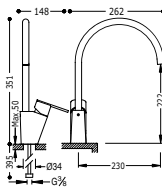

Monomando fregadero vertical LEX-TRES



Cr 1.81.341

Ref:

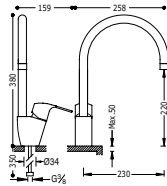

Monomando fregadero vertical K-TRES



Cr | 1.69.440

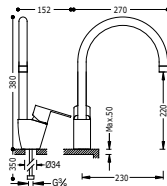

Monomando fregadero vertical BM-TRES



Cr | 1.17.440

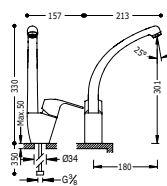

Monomando fregadero vertical K-TRES



Cr | 069.440.01

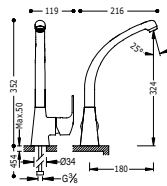

Monomando fregadero vertical K-TRES



Cr | 069.447.01

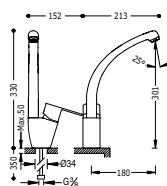

Monomando fregadero vertical BM-TRES



Cr | 017.440.01

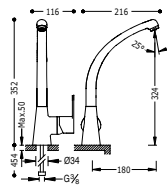

Monomando fregadero vertical BM-TRES



Cr | 017.447.02



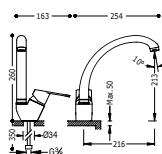

Monomando fregadero vertical BM-TRES



Cr | 1.39.441

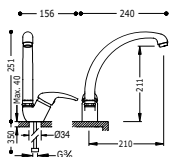

Monomando fregadero vertical BASIC

Cr | 1.30.338

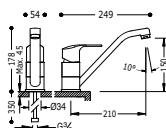

Monomando fregadero vertical K-TRES



Cr | 1.69.333

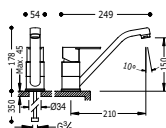

Monomando fregadero vertical BM-TRES



Cr | 1.17.333

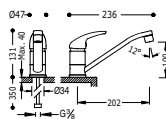

Monomando fregadero vertical BASIC

Cr | 1.30.337

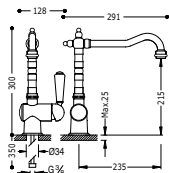

Monomando fregadero vertical RETRO-TRES

Cr | 1.24.341  
 Lv | 5.24.341.01  
 Ac | 5.24.341.03







COCINA EXTRAÍBLE

Ref:

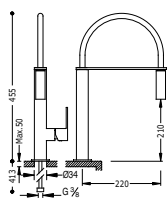

Monomando fregadero vertical CUADRO-TRES  
con rociador extraíble



Ø 35 360° 91.30.190

Cr 1.06.487

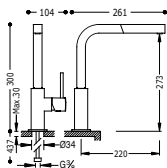

Monomando fregadero vertical CUADRO-TRES  
con ducha extraíble



Ø 35 360° 91.07.190.05

Cr 1.06.437

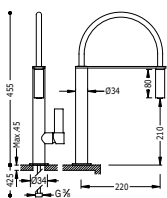

Monomando fregadero vertical CLASS-TRES  
con rociador extraíble



Ø 34 360° 91.30.190

Cr 205.487.01

Ref:

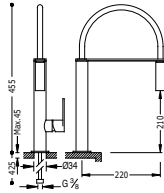

**Monomando fregadero vertical MAX-TRES**  
con rociador extraíble



Ø 35 360° 91.30.190  
**Cr 1.30.487**

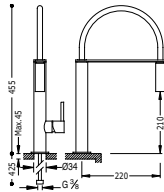

**Monomando fregadero vertical MAX-TRES**  
con rociador extraíble



Ø 35 360° 91.30.190  
**Cr 062.487.01**

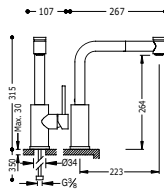

**Monomando fregadero vertical MAX-TRES**  
con ducha extraíble (2 funciones)

Ø 35 360° 91.34.591  
**Cr 1.62.438**

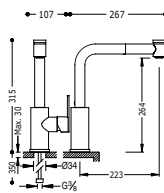

**Monomando fregadero vertical LEX-TRES**  
con ducha extraíble (2 funciones)

Ø 35 360° 91.34.591  
**Cr 1.81.438**

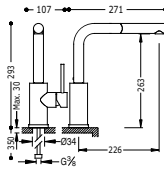

**Monomando fregadero vertical MAX-TRES**  
con ducha extraíble

Ø 35 360° 91.34.591  
**Cr 1.62.437**

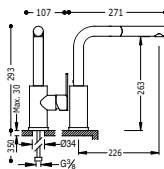

**Monomando fregadero vertical LEX-TRES**  
con ducha extraíble

Ø 35 360° 91.34.591  
**Cr 1.81.437**

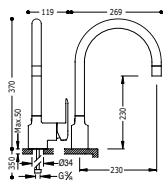

Monomando fregadero vertical  
con rociador extraíble



Cr | 1.14.444

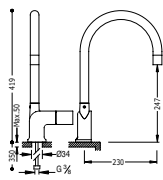

Monomando fregadero vertical  
con rociador extraíble



Cr | 1.87.444

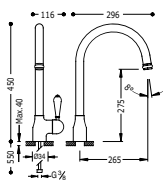

Monomando fregadera vertical RETRO-TRES  
con rociador extraíble



Cr | 1.30.432

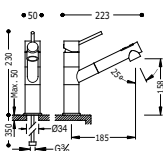

Monomando fregadero vertical  
con ducha extraíble (2 funciones)



Cr | 1.30.434

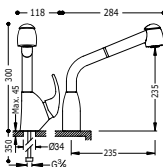

Monomando fregadero vertical  
con ducha extraíble (2 funciones)



Cr | 030.444.01

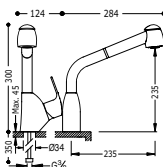

Monomando fregadero vertical K-TRES  
con ducha extraíble (2 funciones)



Cr | 069.444.01





COCINA ABATIBLE

Ref.:

Monomando fregadero vertical ABATIBLE

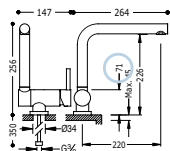

Cr 1.30.335

Monomando fregadero vertical ABATIBLE  
RETRO-TRES

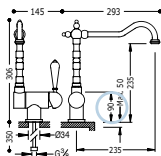

Cr	1.24.334
Lv	5.24.334.01
Co	5.24.334.02
Ac	5.24.334.03



1.61.445  
Un agua

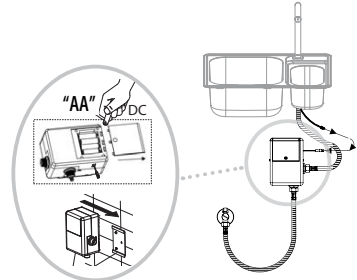

1.61.446  
Mezclador

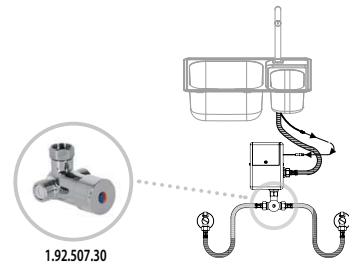

**COCINA ELECTRÓNICA**

Ref.:

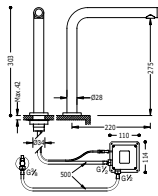

Fregadera electrónica 1 agua TOUCH-TRES  
Sistema sensible al tacto. Sólo tocar (NO pulsar)



Cr 1.61.445

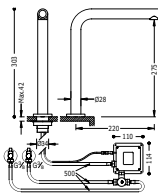

Fregadera electrónica mezclador TOUCH-TRES  
Sistema sensible al tacto. Sólo tocar (NO pulsar). NOTA:  
Incluye un grifo mezclador dos aguas con tubos flexibles (ref. 1.92.507.30).



Cr 1.61.446

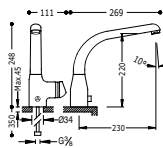

Monomando cocina electrónica  
Mezclador



Cr 1.92.445

Agua filtrada **sin cloro** con un sólo grifo en la cocina.  
 La solución más eficaz y fácil para tener agua sin cloro en casa sin tener que comprar y transportar botellas de agua.

Según los estudios realizados, **el agua osmotizada**, es excesivamente baja en minerales, razón por la cual, **no es recomendable para su consumo diario**.

El **FILTRO ANTICLORO de TRES** asegura un índice bajo en cloro, eliminando el mal sabor de agua pero respetando las propiedades minerales del agua de red.



El cierre está incorporado justo en la salida del agua, eliminando el contacto del agua con el aire y evitando así su contaminación.



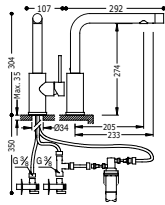

**Monomando fregadero vertical**  
doble función con filtro

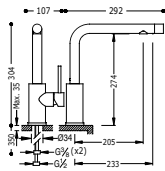

**Monomando fregadero vertical**  
doble función sin filtro. NOTA: para instalaciones de osmosis.

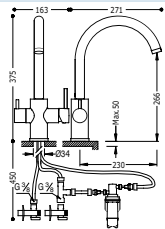

**Monomando fregadera vertical ECOSMOSIS**  
doble función con filtro

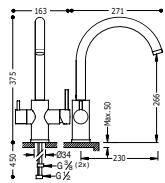

**Monomando fregadera vertical ECOSMOSIS**  
doble función sin filtro. NOTA: para instalaciones de osmosis.



**Filtro ANTICLORO modelos posteriores año 2010**  
sólo filtro (sin conexiones)

1.62.355.90

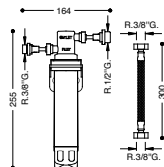

**Filtro ANTICLORO modelos anteriores año 2010**  
Filtro + mecanismo con conexiones

1.34.453.01



COCINA INDUSTRIAL

Ref:

Monomando fregadero vertical MAX-TRES  
Ducha de dos posiciones

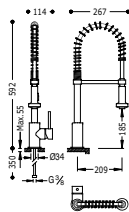

Ø 35 360° 91.34.290

Cr 1.30.493

Monomando fregadero vertical  
Ducha de dos posiciones

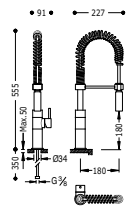

Ø 33 360° 91.34.591

Cr 1.30.485





COCINA MURAL

Ref:

Monomando mural CUADRO-TRES

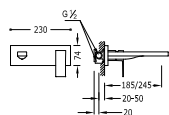

91.30.190 (185 mm.)  
Cr 006.200.03

91.30.190 (245 mm.)  
Cr 006.200.04

Monomando mural LOFT-TRES

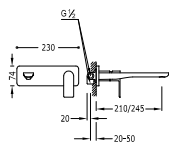

91.30.190 (210 mm.)  
Cr 200.200.03

91.30.190 (245 mm.)  
Cr 200.200.02

Monomando mural CLASS-TRES

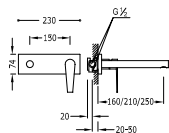

91.30.190 (210 mm.)  
Cr 205.200.41

91.30.190 (250 mm.)  
Cr 205.200.01

Ref:

Monomando mural MAX-TRES

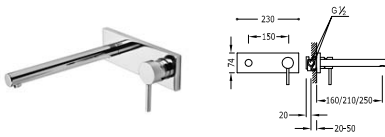

91.34.592 (210 mm.)  
Cr **062.200.02**

91.34.592 (250 mm.)  
Cr **1.62.200**

Monomando mural LEX-TRES

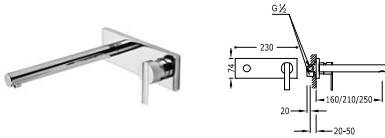

91.34.592 (210 mm.)  
Cr **081.200.21**

91.34.592 (250 mm.)  
Cr **1.81.200**

Monomando mural CUADRO-TRES

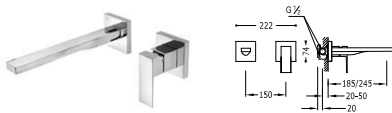

91.30.190 (185 mm.)  
Cr **006.200.12**

91.30.190 (245 mm.)  
Cr **006.200.11**

Monomando mural CLASS-TRES

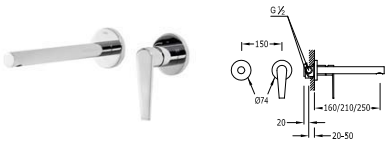

91.30.190 (210 mm.)  
Cr **205.200.71**

91.30.190 (250 mm.)  
Cr **205.200.02**

Monomando mural MAX-TRES

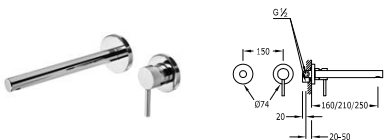

91.30.190 (210 mm.)  
Cr **062.200.71**

91.30.190 (250 mm.)  
Cr **062.200.03**

Bimando mural CUADRO-TRES

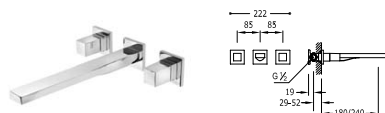

91.34.282 (180 mm.)  
Cr **008.153.01**

91.34.282 (240 mm.)  
Cr **008.154.01**

Bimando mural BIMAX-TRES

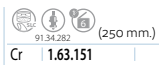
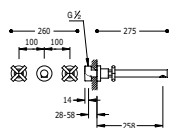

Cr 1.63.151



**COCINA BIMANDO**

Ref:

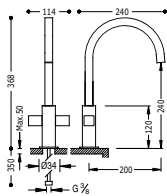

**Bimando fregadero vertical CUADRO-TRES**  
caño de 22x22 mm.

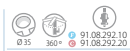

Cr **1.08.497**

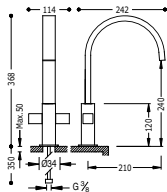

**Bimando fregadero vertical CUADRO-TRES**  
caño 35x15 mm. con aireador rectangular oculto

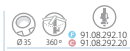

Cr **1.08.498**

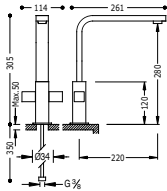

**Bimando fregadero vertical CUADRO-TRES**  
caño de 35x15 mm.



Cr **1.08.496**

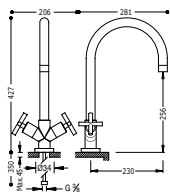

Bimando fregadero vertical BIMAX-TRES



Cr | 1.63.333

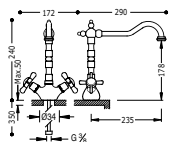

Bimando fregadero vertical RETRO-TRES



Cr | 1.24.342.61

Lv | 5.24.342.01.61

Co | 5.24.342.02.61

Ac | 5.24.342.03.61

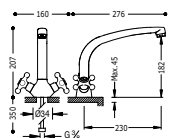

Bimando fregadero vertical CLASIC-TRES



Cr | 1.32.335

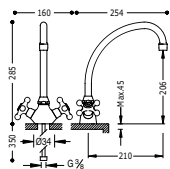

Bimando fregadero vertical CLASIC-TRES



Cr | 1.32.342

Lv | 5.32.342.01

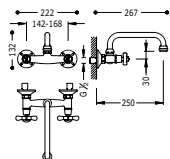

Grupo fregadero pared RETRO-TRES

Distancia a pared de 250 mm.



Cr | 024.215.01

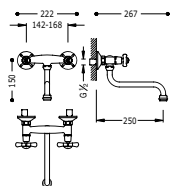

Grupo fregadero pared RETRO-TRES

Distancia a pared de 250 mm.



Cr | 024.310.01



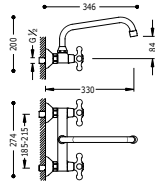

**Grupo fregadero pared CLASIC-TRES**

Distancia a pared de 330 mm.



Cr | 1.32.416 |





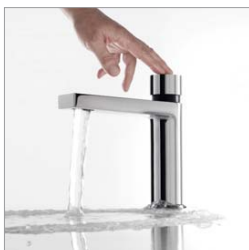

## TEMPORIZADAS Y ELECTRÓNICAS



Lavabos

546



Grifos para urinario

550



Grifos de ducha

551



Cocinas

553

[www.tresgriferia.com](http://www.tresgriferia.com)



RECAMBIOS  
DE LOS ARTICULOS EN  
[www.tresgriferia.com](http://www.tresgriferia.com)



GRIFO TEMPORIZADO PARA LAVABO

Ref.:

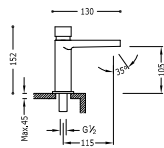

Lavabo temporizado 1 agua  
Cierre automático: 6 seg.



299.396.01 6"

Cr **205.112.01**

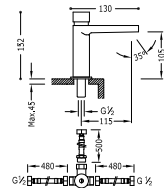

Lavabo temporizado mezclador  
Cierre automático: 6 seg. NOTA: Incluye un grifo mezclador dos aguas con tubos flexibles (ref. 1.92.507.30).



299.396.01 6"

Cr **205.112.02**

**N**

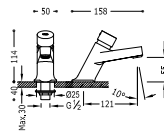

Lavabo temporizado 1 agua  
Cierre automático: 6 seg.



299.396.01 6"

Cr **012.103.03**

**N**

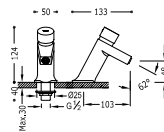

Lavabo temporizado 1 agua  
Cierre automático: 6 seg.



299.396.01 6"

Cr **012.103.02**

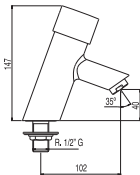

Lavabo temporizado 1 agua  
Cierre automático: 6 seg. Caudal: 6,5 l/min.



91.12.284 6"

Cr **1.12.203**

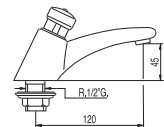

Grifo lavabo encimera  
entrada tubo 10x12. Cierre automático: 15 seg. Caudal: 6,5 l/min.



15"

Cr **1.12.103**

**N**

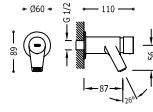

**Grifo lavabo mural**

rosca macho 1/2" G. Cierre automático: 6 seg. Caudal: 6,5 l/min.



299.396.01 6"  
Cr 012.100.02

**N**

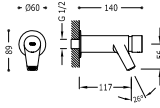

**Grifo lavabo mural**

rosca macho 1/2" G. Cierre automático: 6 seg. Caudal: 6,5 l/min.



299.396.01 6"  
Cr 012.100.03

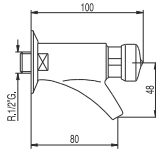

**Grifo lavabo mural**

rosca macho 1/2" G. Cierre automático: 15 seg. Caudal: 6,5 l/min.



15"  
Cr 1.12.100



GRIFO ELECTRÓNICO PARA LAVABO

Ref.:

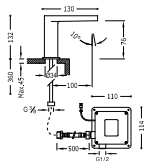

Lavabo electrónico 1 agua

Accionado mediante sensor de infrarrojos



Cr 205.603.01

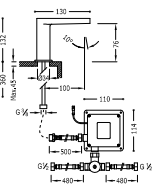

Lavabo electrónico mezclador

Accionado mediante sensor de infrarrojos. NOTA: Incluye un grifo mezclador dos aguas con tubos flexibles (ref:1.92.507.30).



Cr 205.603.02

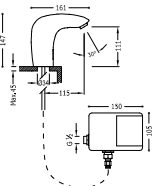

Lavabo electrónico 1 agua

Accionado mediante sensor de infrarrojos



Cr 1.92.606.03

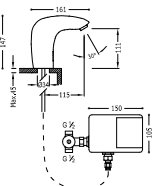

Lavabo electrónico mezclador

Accionado mediante sensor de infrarrojos.



Cr 1.92.906.03

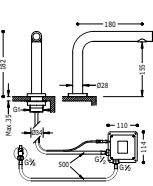

Lavabo electrónico 1 agua TOUCH-TRES

Sistema sensible al tacto. Sólo tocar (NO pulsar)



Cr 061.447.01

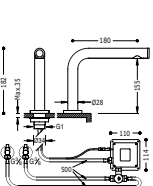

Lavabo electrónico mezclador TOUCH-TRES

Sistema sensible al tacto. Sólo tocar (NO pulsar). NOTA: Incluye un grifo mezclador dos aguas con tubos flexibles (ref: 1.92.507.30).



Cr 061.448.01

Ref:

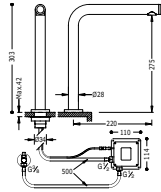

**Lavabo electrónico 1 agua TOUCH-TRES**  
Sistema sensible al tacto. Sólo tocar (NO pulsar)



Cr | **1.61.445**

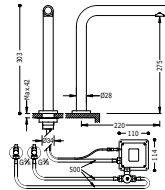

**Lavabo electrónico mezclador TOUCH-TRES**  
Sistema sensible al tacto. Sólo tocar (NO pulsar). NOTA: Incluye un grifo mezclador dos aguas con tubos flexibles (ref: 1.92.507.30).



Cr | **1.61.446**

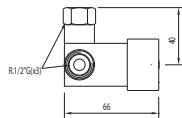

**Mezclador dos aguas CON TUBOS FLEXIBLES**  
para lavabos TRESTRONIC, TOUCH-TRES y TEMPO-TRES

Cr | **1.92.507.30**

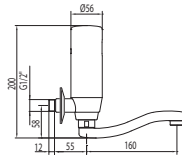

**Lavabo electrónico 1 agua**



Cr | **092.171.01**



GRIFO TEMPORIZADO PARA URINARIO

Ref:



Grifo de urinario

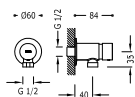

299.396.01

Cr | 012.200.02

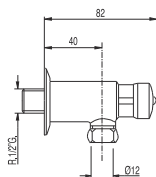

Grifo de urinario

entrada posterior, rosca macho 1/2" G. Salida con tuerca y junta para tubo 10x12. Caudal: 16 l/min.



Cr | 1.12.200

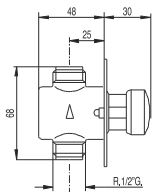

Grifo de urinario para empotrar

rosca macho 1/2" G.



Cr | 012.208.01

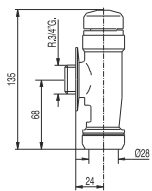

Fluxor para inodoros

entrada rosca macho 3/4" G. Salida para tubo 26x28. Caudal: 1,5 l/seg.



Cr | 1.12.205

GRIFO ELECTRÓNICO PARA URINARIO

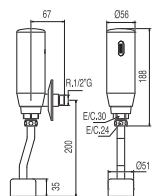

1.12.206

Cr | 1.12.206

Grifo electrónico visto para urinario

Con dos tubos adaptables a urinario

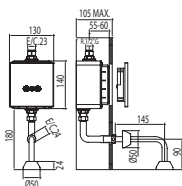

1.12.207.01

Cr | 012.207.01

Grifo electrónico empotrado para urinario



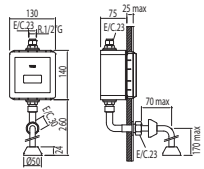

Grifo electrónico empotrado para urinario



Cr 1.12.207

**GRIFO TEMPORIZADO PARA DUCHA**

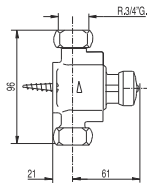

Grifo de ducha

alimentación exterior por parte inferior, entrada y salida con tuerca y junta para tubo 13x15. Cierre automático: 15 seg. Caudal: 6 l/min.



Cr 1.12.167

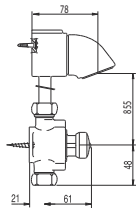

Conjunto de ducha grifo más rociador

alimentación exterior por parte inferior, con tuerca y junta para tubo 13x15 y regulador automático de caudal incorporado: 16 l/min.



Cr 1.12.161

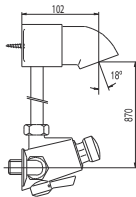

Conjunto mezclador para ducha

Entradas opuestas con racores extensibles. Regulador automático de caudal incorporado en el rociador. Válvulas antirretorno en las entradas. Caudal: 16 l/min.



Cr 1.12.163

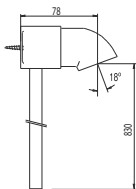

Rociador + tubo

Caudal: 6 l/min.



Cr 1.12.161.50



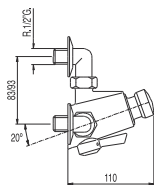

**Grifo mezclador para ducha**

Entradas opuestas y salida vertical. Equipado con 3 racores extensibles. Válvulas antirretorno en las entradas. Caudal: 16 l/min.



Cr 1.12.162

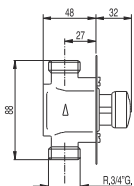

**Grifo de ducha para empotrar**

entrada y salida con rosca macho 3/4" G. Caudal: 20 l/min.



Cr 1.12.178

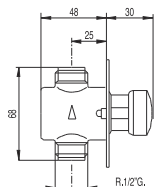

**Grifo de ducha para empotrar**

entrada y salida con rosca macho 1/2" G. Caudal: 16 l/min.



Cr 1.12.177

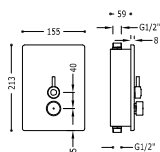

**Grifo mezclador para ducha**

con 2 entradas de agua



Cr 012.179.01

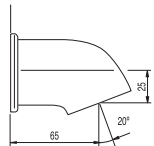

**Rociador antivandálico**

con regulador automático de caudal: 6 l/min.



Cr 1.34.168.03

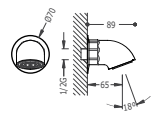

**Rociador para ducha**

con regulador automático de caudal. Rosca 1/2" G.



Cr 1.34.167.03

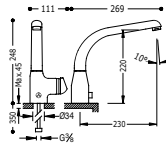

**Monomando cocina electrónico**  
Mezclador



360° 91.34.290  
Cr 1.92.445

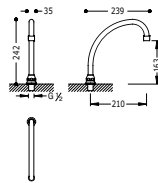

**Caño fregadero**  
con enlace



360°  
Cr 1.12.441

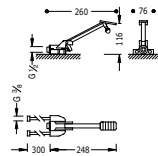

**Grifo de pedal**

Mezclador. Presionando el pedal aumenta progresivamente la temperatura del agua, siempre con un caudal constante.

Cr 1.12.370

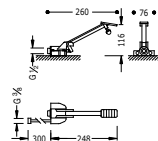

**Grifo de pedal**

Un agua. Presionando el pedal aumenta progresivamente el caudal.

Cr 1.12.360



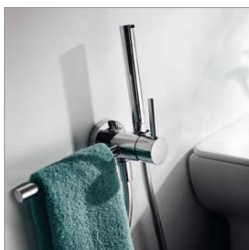

## GRIFERÍA ESPECIAL



Bidé

556



Medicales

560



Peluquería

561



Cocina

561



Jardín - Piscina

562



Vino

563

[www.tresgriferia.com](http://www.tresgriferia.com)



RECAMBIOS  
DE LOS ARTICULOS EN  
[www.tresgriferia.com](http://www.tresgriferia.com)

## SUSTITUYA EL BIDÉ Y APROVECHE ESPACIO

Aprovecha el espacio del baño ya que se sustituye el bidé tradicional por un grifo que aprovecha el recipiente del váter.

Instalación sencilla en poco espacio.

El sistema Protec-tres® permite la elección de la posición máxima de apertura de la palanca en agua caliente, evitando posibles quemaduras.



## SOLUCIÓN SIN OBRAS



- Monomando especial de lavabo con una salida específica para la ducha/bidé.
- Instalación sencilla utilizando la toma de agua compartida con el monomando de lavabo.
- Ducha de mano con cierre y válvula antirretorno. Flexo SATIN.

## SOLUCIÓN CON OBRAS



- Monomando mezclador empotrado con soporte de ducha/bidé integrado.
- Diseños cuadrado o redondo, con distintos modelos de maneta. Cada modelo dispone de la opción para paredes de pladur.
- El soporte de la ducha de mano puede ir a la izquierda o a la derecha, cambiabile.
- La ducha de mano es de latón con racor limitador 5 l/min. Con sistema antigoteo. Flexo SATIN.
- Se puede acoplar un accesorio para toallas disponible en diseño cuadrado y redondo (se vende por separado).



BIDÉ

Ref.:

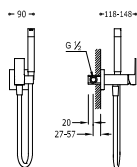
**Monomando mezclador empotrar para bidé WC**

Soporte derecha o izquierda, cambiabile. Ducha de latón con racor limitador 5 l/m. Antigoteo y flexo SATIN. \* Opción para paredes de Pladur



91.30.190

Cr 006.123.01

Cr 006.123.02\*

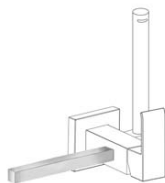
**Accesorio porta toallas**

180 mm. (para ref.: 006.123.01, 006.123.02) \* NOTA: Soporte derecha o izquierda, cambiabile.

Cr 034.124.02

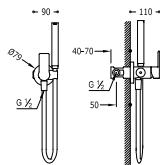
**Monomando mezclador empotrar para bidé WC**

Soporte derecha o izquierda, cambiabile. Ducha de latón con racor limitador 5 l/m. Antigoteo y flexo SATIN. \* Opción para paredes de Pladur



91.34.591

Cr 205.223.01

Cr 205.222.01\*

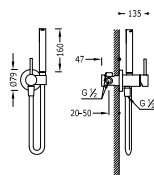
**Monomando mezclador empotrar para bidé WC**

Soporte derecha o izquierda, cambiabile. Ducha de latón con racor limitador 5 l/m. Antigoteo y flexo SATIN. \* Opción para paredes de Pladur



91.34.591

Cr 1.34.123

Cr 1.34.122\*

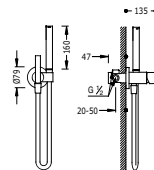
**Monomando mezclador empotrar para bidé WC**

Soporte derecha o izquierda, cambiabile. Ducha de latón con racor limitador 5 l/m. Antigoteo y flexo SATIN. \* Opción para paredes de Pladur



91.34.591

Cr 1.81.223

Cr 1.81.222\*

**Accesorio porta toallas**

180 mm. (para ref.: 1.34.122, 1.34.123, 1.81.122, 1.81.123, 205.222.01, 205.223.01) \* NOTA: Soporte derecha o izquierda, cambiabile.

Cr 034.124.01





MEDICALES

Ref.:

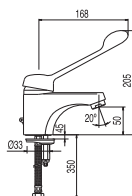

**Monomando lavabo**  
con palanca medical



91.34.290

Cr | 1.70.103.02.11 |

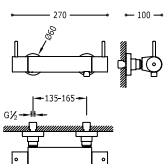

**Ducha termostática**

Ducha de mano anticalcárea (299.631.03) con soporte orientable y flexo SATIN (91.34.609.15). Indicado para personas con discapacidades físicas



299.195.09

Cr | 090.264.01 |



299.195.09

Cr | 090.964.01 |

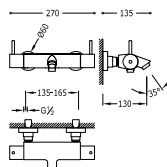

**Bañera-ducha termostática**

Ducha de mano anticalcárea (299.631.03) con soporte orientable y flexo SATIN (91.34.609). Indicado para personas con discapacidades físicas



299.195.09

Cr | 090.274.01 |



299.195.09

Cr | 090.974.01 |

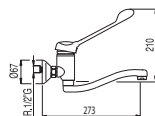

**Monomando fregadero pared**  
con palanca medical



135-165 360° 91.34.290

Cr | 1.72.318.11 |

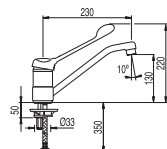

**Monomando fregadero vertical**  
con palanca medical



300° 91.34.290

Cr | 1.72.333.11 |

Ref:

**Palanca medical monomando**  
(para ref.: ECO-TRES, MONOTRES 2000)

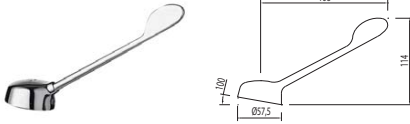

Cr 91.34.011

**PELUQUERÍA**

**Monomando peluquería**

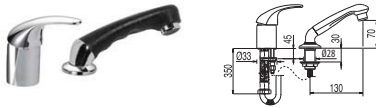

91.34.288  
Cr 1.72.450

**COCINA**

**Caño fregadero**

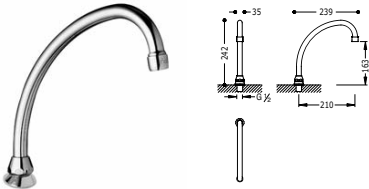

360°  
Cr 1.12.441

**Grifo de pedal**

Mezclador. Presionando el pedal aumenta progresivamente la temperatura del agua, siempre con un caudal constante.

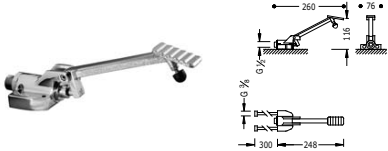

Cr 1.12.370

**Grifo de pedal**

Un agua. Presionando el pedal aumenta progresivamente el caudal.

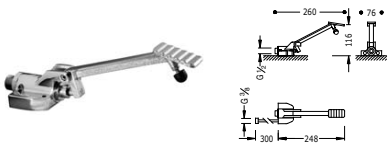

Cr 1.12.360

JARDÍN - PISCINA

Ref.:

Ducha de jardín o piscina  
Monomando de agua fría y caliente

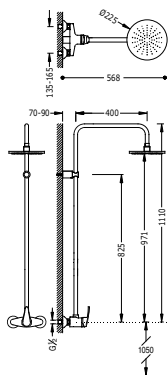

Cr 070.995.01

Ducha de jardín o piscina  
Temporizada de 1 agua

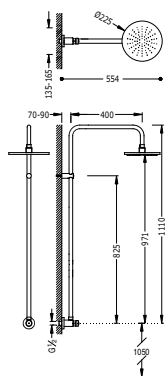

Cr 012.996.01

Grifo jardín  
con aireador

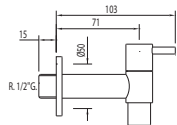

Cr 034.501.01

Grifo jardín  
para manguera

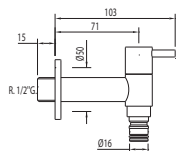

Cr 034.501.02

VINO

Ref.: |

Grifo de vino Nº 5

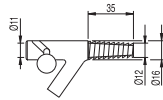

Cr | 0.05.010 |

Grifo de vino Nº 1/C

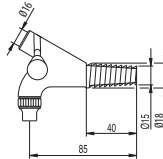

Cr | 0.01.010 |

Grifo de vino Nº 2/C

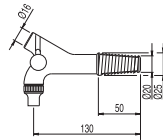

Cr | 0.02.010 |

Grifo de vino Nº 3/C

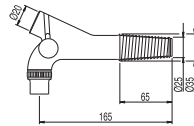

Cr | 0.03.010 |

Grifo de vino Nº 1/N

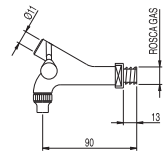

(3/8" G.)  
Cr | 0.01.000 |

(1/2" G.)  
Cr | 0.01.001 |

Grifo de vino Nº 2/N

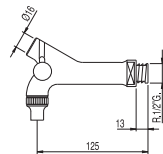

Cr | 0.02.000 |

Grifo de vino Nº 3/N

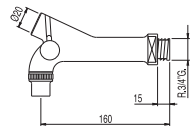

Cr | 0.03.000 |



## MONOTRES 2000

---



Lavabos

566

---



Bidé

566

---



Monomandos de superficie

566

---



Monomandos empotrados

567

---



Bañeras de repisa

567

---



Cocinas

568

---

[www.tresgriferia.com](http://www.tresgriferia.com)



RECAMBIOS  
DE LOS ARTÍCULOS EN  
[www.tresgriferia.com](http://www.tresgriferia.com)

LAVABOS

Ref.:

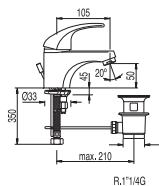

Monomando lavabo

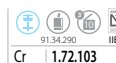

Cr | 1.72.103

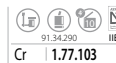

Cr | 1.77.103

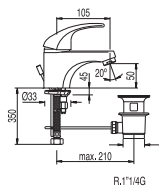

Monomando lavabo ecoeficiente



Cr | 1.72.104



Cr | 1.77.104



BIDÉ

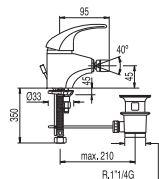

Monomando bidé



Cr | 1.72.120



Cr | 1.77.120

MONOMANDOS DE SUPERFICIE

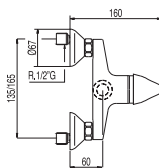

Monomando ducha

Ducha de mano anticálcarea con soporte orientable. Flexo doble engatillado



Cr | 1.72.367

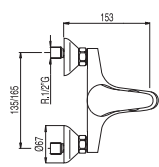

Monomando bañera-ducha

Ducha de mano anticálcarea con soporte orientable. Flexo doble engatillado



Cr | 1.72.370





COCINAS

Ref.:

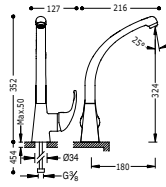

Monomando fregadero vertical



Cr 1.72.447

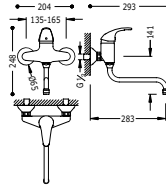

Monomando fregadero pared



Cr 1.72.317

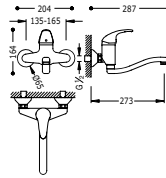

Monomando fregadero pared



Cr 1.72.318

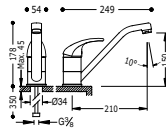

Monomando fregadero vertical

\*(para modelos anterior tarifa 2007 ... 91.34.290)



Cr 1.72.333

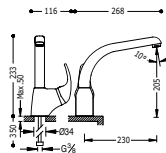

Monomando fregadero vertical



Cr 1.72.440



Bl 4.72.440

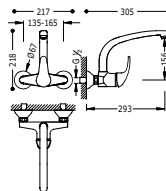

Monomando fregadero pared



Cr 1.72.420

Ref:

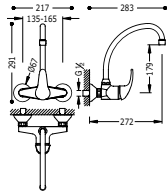

Monomando fregadero pared



135-165 360° 91.34.290  
Cr | 1.72.418

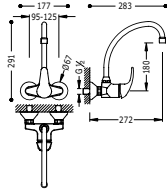

Monomando fregadero pared



95-125 360° 91.34.290  
Cr | 1.72.218

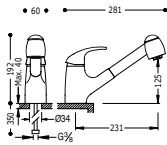

Monomando fregadero vertical  
con ducha extraíble (2 funciones)



033 125° 91.34.591 BELGARA  
Cr | 1.72.443



## ECO-TRES

---



Lavabos

572

---



Bidé

572

---



Monomandos de superficie

573

---



Monomandos empotrados

573

---



Bañeras de repisa

575

---



Cocinas

575

---

[www.tresgriferia.com](http://www.tresgriferia.com)



**RECAMBIOS**  
DE LOS ARTÍCULOS EN  
[www.tresgriferia.com](http://www.tresgriferia.com)

LAVABOS

Ref.:

Monomando lavabo

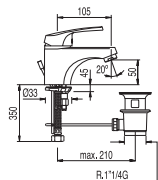

Cr | 1.70.103.02



Cr | 1.75.103.02

Monomando lavabo ecoeficiente

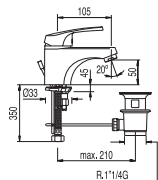

Cr | 1.70.104.02



Cr | 1.75.104.02



Monomando lavabo

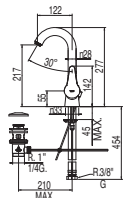

Cr | 1.75.308.02

BIDÉ

Monomando bidé

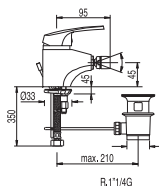

Cr | 1.70.120.02



Cr | 1.75.120.02

**MONOMANDOS DE SUPERFICIE**

Ref.:

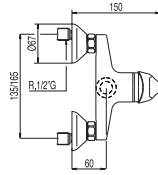

**Monomando ducha**

Ducha de mano anticalcárea con soporte orientable. Flexo doble engatillado

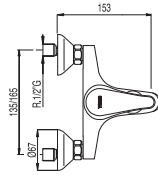

**Monomando bañera-ducha**

Ducha de mano anticalcárea con soporte orientable. Flexo doble engatillado

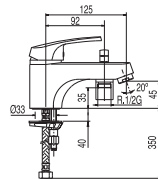

**Monomando bañera**



**MONOMANDOS EMPOTRADOS**

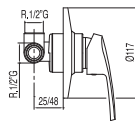

**Monomando empotrar (1 vía)**

cuerpo empotrado incluido

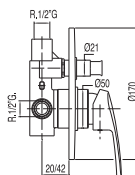

**Monomando empotrar (2 vías)**

cuerpo empotrado incluido





**Kit de ducha monomando empotrado**

- con cierre y regulación de caudal.
- Cuerpo empotrado incluido
- Barra deslizante long. 516 mm.
- Codo toma pared.
- Ducha móvil masaje Ø 80 mm. (2 funciones).
- Flexo SATIN (91.34.609.15).

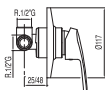
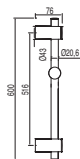

**Kit de ducha monomando empotrado**

- con cierre y regulación de caudal.
- Cuerpo empotrado incluido
- Ducha fija Ø 225 mm. con rótula. (299.632.01).
- Ducha móvil masaje Ø 80 mm. (2 funciones).
- Flexo SATIN (91.34.609.15).



**Kit de ducha monomando empotrado**

- con cierre y regulación de caudal.
- Cuerpo empotrado incluido
- Ducha fija Ø 225 mm. con rótula. (299.632.01).
- Barra deslizante long. 516 mm.
- Codo toma pared (205.183.01).
- Ducha móvil masaje Ø 80 mm. (2 funciones).
- Flexo SATIN (91.34.609.15).

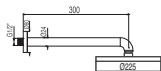



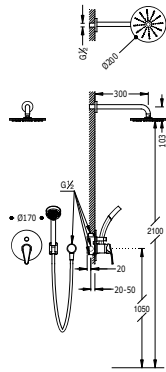

**Kit de ducha monomando empotrado**

- Ducha fija Ø 200 mm. con rótula (299.632.12).
- Codo toma pared.
- Ducha anticalcárea Ø 80 mm.
- Flexo doble engatillado

91.34.290  
Cr | **070.880.02** |

**BAÑERAS DE REPISA**

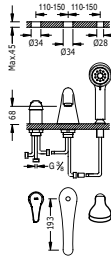

**Monomando bañera de repisa**

- Ducha masaje. (3 funciones).
- Caudal: 3 bar - 15 l/m.

91.34.288  
Cr | **070.145.02** |

**COCINAS**

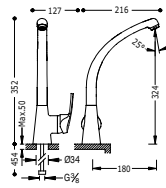

**Monomando fregadero vertical**

91.34.288  
Cr | **1.70.447.02** |

Monomando fregadero vertical

\*(para modelos anterior tarifa 2007 ... 91.34.290)

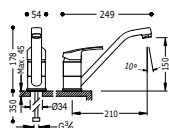

Ø 33 360° 91.34.288° IA IIB
   
**Cr 1.70.333.02**

Monomando fregadero vertical

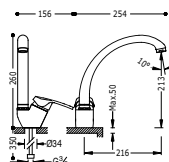

Ø 33 360° 91.34.288°
   
**Cr 1.70.441.02**

Monomando fregadero pared

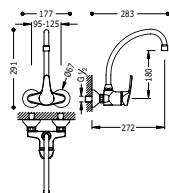

135-165 360° 91.34.290
   
**Cr 1.70.318.02**

95-125 360° 91.34.290
   
**Cr 1.70.218.02**

Monomando fregadero pared

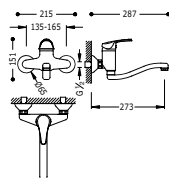

135-165 360° 91.34.290 (200 mm.)
   
**Cr 1.70.320.02**

135-165 360° 91.34.290 (160 mm.)
   
**Cr 1.70.418.02**

135-165 360° 91.34.290 (130 mm.)
   
**Cr 070.320.03**

Monomando fregadero pared

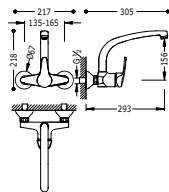

135-165 360° 91.34.290
   
**Cr 1.70.332.02**

Monomando fregadero vertical

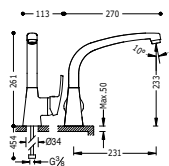

Ø 33 360° 91.34.288°
   
**Cr 070.448.02**

Monomando fregadero vertical

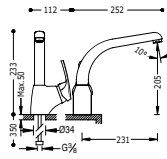

Ø 33    360°    91.34.290    IA

Cr | **1.70.440.02** |





## ESE-23

---



Bimando lavabos

580

---



Bidé

580

---



Bimandos de superficie

581

---



Cocinas

581

---

[www.tresgriferia.com](http://www.tresgriferia.com)



**RECAMBIOS**  
DE LOS ARTÍCULOS EN  
[www.tresgriferia.com](http://www.tresgriferia.com)

BIMANDO LAVABOS

Ref.:

Grifo lavabo

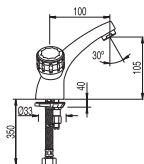

91.34.284

Cr | 1.23.103

Grifo lavabo

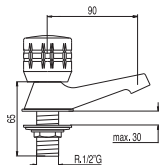

91.34.284

Cr | 1.23.100.F



91.34.284

Cr | 1.23.100.C

Batería lavabo

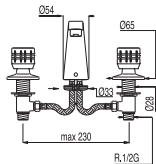

91.34.285

Cr | 1.23.105

Grifo lateral

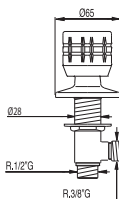

91.34.285

Cr | 1.23.510.F



91.34.285

Cr | 1.23.510.C

BIDÉ

Grifo bidé

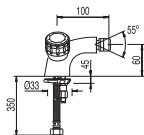

91.34.284

Cr | 1.23.120

Ref:

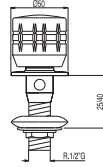

Grifo bidé de 1/2"



91.34.284  
Cr | 1.23.125.F



91.34.284  
Cr | 1.23.125.C

**BIMANDO BAÑO**

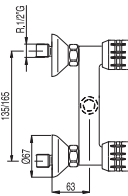

Grupo ducha

Ducha de mano anticalcárea con soporte orientable. Flexo doble engatillado



91.34.284  
Cr | 1.23.167

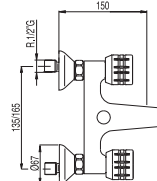

Grupo baño-ducha

Ducha de mano anticalcárea con soporte orientable. Flexo doble engatillado



91.34.284  
Cr | 1.23.170

**COCINAS**

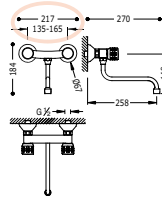

Grupo fregadero pared



115-165 300° 91.34.284  
Cr | 1.23.310

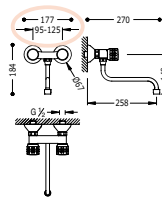

Grupo fregadero pared

Distancia a pared de 260 mm.



95-125 300° 91.34.284  
Cr | 1.23.210

Ref:

		<p>Grupo fregadero pared</p>	<p>9.5-12.5 360° 91.34.284 (207 mm.) Cr   1.23.214</p>
		<p>Grupo fregadero pared</p>	<p>13.5-16.5 360° 91.34.284 (208 mm.) Cr   1.23.314</p>
		<p>Grupo fregadero pared</p>	<p>13.5-16.5 360° 91.34.284 (258 mm.) Cr   1.23.315</p>
		<p>Grupo fregadero pared</p>	<p>18.5-21.5 360° 91.34.284 (298 mm.) Cr   1.23.416</p>
		<p>Grupo fregadero pared</p>	<p>13.5-16.5 360° 91.34.284 (276 mm.) Cr   1.23.317</p>
		<p>Grupo fregadero pared</p>	<p>9.5-12.5 360° 91.34.284 (276 mm.) Cr   1.23.217</p>





Grifo fregadero

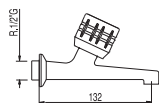

91.34.283

Cr | 1.23.520.F |



91.34.283

Cr | 1.23.520.C |

Grifo fregadero

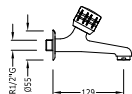

91.34.283

Cr | 023.520.01.F |



91.34.283

Cr | 023.520.01.C |

Grifo lavadora

De 1/2" - 3/4"

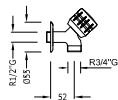

91.34.283

Cr | 1.23.500.F |



91.34.283

Cr | 1.23.500.C |

Llave de paso empotrar

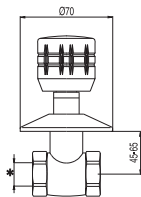

91.34.286

Cr | 1.23.155.F | (1/2")



91.34.286

Cr | 1.23.511.F | (Ø 15 mm.)



91.34.286

Cr | 1.23.512.F | (Ø 18 mm.)



91.34.287

Cr | 1.23.513.F | (Ø 22 mm.)

Llave de paso empotrar

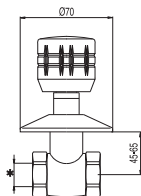

91.34.286

Cr | 1.23.155.C | (1/2")



91.34.286

Cr | 1.23.511.C | (Ø 15 mm.)



91.34.286

Cr | 1.23.512.C | (Ø 18 mm.)



91.34.287

Cr | 1.23.513.C | (Ø 22 mm.)

Ref:

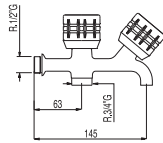

**Grifo lavadora doble**  
De 1/2" - 3/4"



91.34.283  
Cr | **1.23.515**

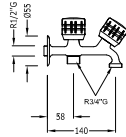

**Grifo lavadora doble**  
1/2" - 3/4" - 3/4"



91.34.283  
Cr | **023.515.01**

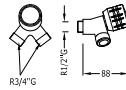

**Grifo doble**  
De 1/2" - 3/4"



91.34.283  
Cr | **023.516.01**

**LLAVES DE PASO**

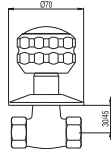

**Llave de paso rosca**  
1/2"



91.34.296  
Cr | **1.33.155.10.F**



91.34.296  
Cr | **1.33.155.10.C**

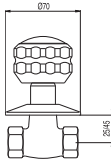

**Llave de paso rosca**  
3/4"



91.34.297  
Cr | **1.33.157.10.F**



91.34.297  
Cr | **1.33.157.10.C**

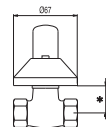

**Llave de paso regulación oculta**



91.34.296 1/2" 20/55  
Cr | **1.33.516**



91.34.297 3/4" 20/60  
Cr | **1.33.517**



91.34.298 1" 30/70  
Cr | **1.33.518**

LISTADO DE REFERENCIAS

Ref.	€	Pág.	Ref.	€	Pág.	Ref.	€	Pág.	Ref.	€	Pág.	Ref.	€	Pág.
<b>00</b>			00626001	384		02352001C	584		03411601RO	230		06116101	411	
001000	563		00626010	384		02352001F	584		03411601VE	230		06116201	238	
001001	563		0064378M	99		02416404	514		03411601VI	230		06116201	412	
001010	563		00648501	381		02416404LV	514		03412401	406		06116201	440	
002000	563		00648501ACD	44		02416409	512		03412401	423		06116201	440	
002010	563		0064868M	96		02416409LV	512		03412401	437		06116209	238	
003000	563		0064878M	99		02417409	512		03412401	437		06116209	412	
003010	563		00661001	379		02417409LV	512		03412401	448		06116701	407	
003010	563		00661001ACD	42		02417609	512		03412401	462		06117001	407	
005010	563		00661001BLD	42		02417609LV	512		03412401	558		06117201	240	
00610101	379		00661001NED	42		02417712	510		03412402	388		06117201	412	
00610101ACD	42		00661002	378		02418012	510		03412402	558		06117201	440	
00610101BLD	42		00663901	230		02418201	335		03433601	312		06117201	440	
00610101D	379		00663901AC	230		02419401LV	370		03433603	311		06117202	366	
00610101NED	42		00663901BL	230		02419401LV	493		03433604	311		06117209	240	
00610102	378		00663901NG	230		02419401LV	502		03450101	562		06117209	315	
00610503	385		00681001	379		02419401LV	512		03450102	562		06118201	332	
00610503AC	45		00681001ACD	42		02419501	513		03452602	311		06118301	337	
00610504	385		00681001BLD	42		02419502	513		03452702	311		06120301	397	
00610504AC	45		00681001NED	42		02419502LV	513		03454002	358		06120301D	397	
00611001	380		00681002	378		02419801	513		03462902	311		06120304	400	
00611001BLD	43		00698001	277		02420301	506		03463628	269		06120306	400	
00611001D	380		00698001	390		02420301LV	506		03463629	269		06120601	397	
00611001NED	43		00712001	387		02421301	500		03463630	269		06120701	357	
00611002	380		00712001ACD	46		02421301	509		03463701	307		06121001	296	
00611002BLD	43		00712001BLD	46		02421301LV	500		03463702	308		06121001	414	
00611002D	380		00712001D	387		02421301LV	509		03463706	310		06122001	405	
00611002NED	43		00712001NED	46		02421501	542		03463707	313		06122001D	405	
00612001	387		00715501	393		02422001	508		03463708	308		06125001	242	
00612001ACD	46		00716402	258		02422001LV	508		03463901	230		06125002	243	
00612001BLD	46		00717402	263		02431001	542		03463901AC	230		06125003	243	
00612001D	387		00719101	272		02447601	317		03463901AM	230		06125004	243	
00612001NED	46		00719101	388		02487101	369		03463901BL	230		06138501	260	
00612301	388		00719101	253		02487101	493		03463901FU	230		06138502	265	
00612301	558		00719701	272		02487101	502		03463901NA	230		06139301	256	
00612302	388		00731201	262		02487101	512		03463901NE	230		06139301	413	
00612302	558		00731201	392		02487101LV	493		03463901RO	230		06144701	402	
00613001	387		00738501	259		02487101LV	502		03463901VE	230		06144701	435	
00616103	287		00738502	264		02487101LV	512		03463901VI	230		06144701	435	
00616103	391		00749501	252		<b>03</b>			03474007	362		06144701	548	
00616103AC	48		00750301AC	44		030335AC	100		03493101	229		06144801	402	
00616104	287		00810501	386		030335BM	100		03493199	229		06144801	435	
00616104	391		00810501AC	46		030336AC	98		03493201	229		06144801	435	
00616105	287		00810502	386		030336BM	98		03493299	229		06144801	548	
00616105	391		00810503	386		030336BM	98		03944401	531		06151101	415	
00616105AC	48		00810503AC	45		03035501	535		<b>04</b>			06151101	428	
00616106	287		00810504	386		03044401	530		04217712	491		06163504	319	
00616106	391		00815010	385		03045501	535		04218012	491		06163505	318	
00617703	275		00815010	385		030496BM	96		04219401	492		06163506	320	
00618003	276		00815301	386		0304978M	96		04219401LV	492		06163507	321	
00618003	390		00815301	539		030498BM	96		04219402LV	492		06163509	323	
00618003AC	47		00815301AC	46		03216402	494		<b>06</b>			06183901AM	233	
00618006	277		00815301AC	101		03216402	502		06110301	396		06183901BL	233	
00618080	276		00815401	386		03216402LV	494		06110302	396		06183901FB	233	
00618080	390		00815401	539		03216409	493		06110302	399		06183901NA	233	
00618201	335		00815401AC	46		03216409LV	493		06110302D	400		06183901RO	233	
00618201AC	335		00815401AC	101		03216409LV	501		06110302D	400		06183901VE	233	
00618301	337		<b>01</b>			03217409	493		06110303	399		06183901VI	233	
00618301AC	337		01210002	547		03217409	501		06110303	399		06184902	314	
00620003	384		01210003	546		03217409LV	493		06110303	400		06192801	313	
00620003	538		01210302	546		03217409LV	501		06110303D	399		06193102	315	
00620003AC	44		01210303	546		03217609	493		06110303D	400		06193103	315	
00620003AC	100		01217901	552		03217609LV	493		06110501	60		06193104	315	
00620004	384		01220002	550		03217609LV	493		06110502	60		06193105	315	
00620004	538		01220701	550		03217609LV	501		06111001	399		06210301	396	
00620004AC	44		01220801	550		03219501	494		06112001	405		06210301D	396	
00620004AC	100		01229601	562		03219501	503		06112001ACD	61		06210302	399	
00620010	384		01229601	485		03219502	494		06112001BMD	61		06210302	401	
00620011	385		01229601	485		03219502	502		06112001TAMD	61		06210302D	399	
00620011	539		01229601	485		03219502LV	494		06112001TBLD	61		06210302D	401	
00620011AC	44		01271712	485		03219502LV	502		06112001TFLAD	61		06210303	399	
00620011AC	100		01271712	537		03219801	495		06112001TFLAD	61		06210303	401	
00620012	385		01271802	485		03219801	503		06112001TFLAD	61		06210303D	399	
00620012	539		01271802	486		03411601	230		06112001TFLAD	61		06210303D	401	
00620012AC	44		01370802D	484		03411601AC	230		06112001TFLAD	61		06210303D	401	
00620012AC	100		01744001	525		03411601AM	230		06112001TFLAD	61		06211001	399	
00620101	380		01744702	525		03411601BL	230		06112001TFLAD	61		06212001	405	
00620101ACD	43		<b>02</b>			03411601BL	230		06115501	415		06212001ACD	61	
00620101BLD	43		02351501	585		03411601FU	230		06115501	415		06212001BMD	61	
00620101NED	43		02351601	585		03411601NA	230		06115501	415		06212001D	405	
00620501ACD	44					03411601NE	230		06116101	289		06212001TAMD	61	

Ref.	€	Pág.	Ref.	€	Pág.	Ref.	€	Pág.	Ref.	€	Pág.	Ref.	€	Pág.
06212001BLD	61		06339301	414		09097401	453		10620501	381		112100	547	
06212001FUD	61		06910302	476		09097401	466		106245	290		112103	547	
06212001TNAD	61		06910302D	476		09097401	560		106245	391		112161	551	
06212001TNEO	61		06913001	477		09217101	549		106377	275		11216150	551	
06212001TROD	61		06916702	477		09286299	162		106437	528		112162	552	
06212001TVED	61		06917002	477		09286301	177		106440	521		112163	551	
06212001TVID	61		06917501	478		09286302	177		106486	520		112167	551	
06213001	406		06917712	478		09286303	178		106486AM	96		112177	552	
06215001AC	66		06918012	478		09286304	178		106486FA	96		112178	552	
06216102	288		06918080	479		09286305	179		106486NA	96		112200	550	
06216102	410		06930802D	476		09286306	179		106486RO	96		112203	446	
06216103	288		06944401	525		09286307	180		106486VE	96		112203	460	
06216103	410		06944401	530		09286308	180		106486VI	96		112203	546	
06216402	258		06944701	525		09286309	181		106487	528		112205	550	
06216801	194					09286310	181		106487AM	99		112206	550	
06217402	264					09286311	182		106487FU	99		112207	551	
06217702	408					09286312	182		106487NA	99		112360	537	
06217703	278					09286313	183		106487RO	99		112360	553	
06217801	194					09286314	183		106487VE	99		112360	561	
06218002	408					09286315	184		106487VI	99		112370	537	
06218003	197					09286316	184		106603	382		112370	553	
06218005	279					09286317	185		106604	382		112370	561	
06218006	198					09286318	185		106605	382		112441	553	
06218007	198					09286319	186		106606	382		112441	561	
06218008	199					09286320	186		106607	382		113333	527	
06218009	279					09286321	187		10691405	265		114444	530	
06218009	410					09286322	187		10691405	339		11463601	346	
06218010	198					09286398	163		106980	276		11463602	346	
06218011	199					09286399	162		106980	389		11463603	346	
06218012	200					09286401	188		106985	277		11463609	346	
06218013	201					09286402	188		107103	381		11463610	346	
06218080	409					09286403	189		10710342	362		117103	484	
06220001	404					09286404	189		107103DA	381		117103DA	484	
06220002	404					09286405	190		107131	316		117104	484	
06220002	539					09286406	190		10716102	289		117104DA	484	
06220002AC	101					09286407	191		10716102	391		117145	487	
06220003	404					09286408	191		107164	238		117175	486	
06220003	539					09286499	163		107164	392		117333	526	
06220003AC	101					09286501	249		1071649	238		117377	486	
06220070	404					09286502	249		1071649	392		117440	525	
06220071	404					09286508	249		107167	388		117980	487	
06220071	539					09286551	37		10717002	388				
06220071AC	101					09286551	164		107174	240				
062200AC	101					09286552	165		107174	392		123100C	580	
062200BM	101					09286553	169		1071749	240		123100F	580	
06220301	398					09286554	69		1071749	392		123103	580	
06220301D	398					09286554	171		107181	366		123105	580	
06220304	401					09286555	172		107250	242		123120	580	
06220306	401					09286556	176		107251	243		123125C	581	
06220601	398					09286557	173		107252	243		123125F	581	
06220701	398					09286558	174		107253	243		123155C	584	
06222001	405					09286561	166		107395	253		123155F	584	
06222001D	405					09286562	166		107395	392		123167	581	
06226010	404					09286563	167		107440	521		123170	581	
06231201	263					09286564	167		107476	317		123210	581	
06231201	415					09286565	173		107503	384		123214	582	
06237801	195					09286566	174		107511	393		123215	582	
06243201	305					09286567	175		10763601	345		123217	582	
062435AC	97					09286568	175		10763603	345		123230	582	
062435BM	97					09286570	169		10763606	345		123306	583	
06243601AC	98					09286571	170		10763608	345		123310	581	
06243601BM	98					09286573	176		10763620	345		123314	582	
06248701	529					09286580	164		10763623	345		123315	582	
06248801	521					09286581	165		10763627	345		123317	582	
06251601	279					09286582	171		107839	336		123330	582	
06251601	409					09286583	172		107922	307		123342	582	
06254201	523					09286584	168		107926	316		123360	583	
06254201AC	98					09096001	246		107934	312		123416	582	
06254201BM	98					09096002	246		107935	307		123500C	584	
06290501	402					09096401	239		107940	355		123500F	584	
06290502	402					09096401	413		104840	361		123505	583	
06290503	402					09096401	427		104841	361		123506	583	
06298001	278					09096401	440		106103	381		123510C	580	
06298001	409					09096401	440		106103DA	381		123510F	580	
06298002	280					09096401	453		106124	387		123511C	584	
06316201	412					09096401	465		10616102	289		123511F	584	
06316209	412					09096401	560		10616102	391		123512C	584	
06317201	412					09097401	241		106177	389		123512F	584	
06317209	412					09097401	413		10617710	389		123513C	584	
06321101	414					09097401	427		106180	389		123513F	584	
06331201	263					09097401	440		10618010	389		123515	585	
06331201	415					09097401	440		106200	384		123520C	584	



Ref.	€	Pág.	Ref.	€	Pág.	Ref.	€	Pág.	Ref.	€	Pág.	Ref.	€	Pág.
17231811	560		186207	445		20010302AMD	74		20016409RO	85		20020002	538	
172333	568		186217	445		20010302AMD	76		20016409VE	85		20020002AC	82	
17233311	560		186903	445		20010302BLD	74		20016409VI	85		20020002AC	101	
172367	566		186920	447		20010302BLD	76		20016701	424		20020003	422	
172370	566		18718250	365		20010302BMD	74		20016701AC	83		20020003	538	
172418	569		187440	521		20010302BMD	77		20016701AM	83		20020303	420	
172420	568		187444	530		20010302D	419		20016701BL	83		20020303ACD	79	
172440	568		189245	291		20010302D	418		20016701BM	83		20020303AMD	78	
172443	569		189245	452		20010302FUD	74		20016701FU	83		20020303BLD	78	
172447	568					20010302FUD	74		20016701NA	83		20020303BMD	79	
172450	561					20010302NAD	74		20016701NE	83		20020303FUD	78	
17510302	572		190150	245		20010302NAD	76		20016701RO	83		20020303NAD	78	
17510402	572		190151	246		20010302NED	74		20016701VE	83		20020303NED	78	
17512002	572		190162	239		20010302NED	76		20016701VI	83		20020303ROD	78	
17530802	572		1901629	239		20010302ROD	74		20017001	424		20020303VED	78	
177103	566		190165	245		20010302ROD	76		20017001AC	84		20020303VID	78	
177104	566		190172	241		20010302VED	74		20017001AM	84		20020304	419	
177120	566		1901729	241		20010302VED	76		20017001BL	84		20020304ACD	77	
			190186	239		20010302VID	74		20017001BM	84		20020304AMD	76	
			190194	514		20010302VID	76		20017001FU	84		20020304BLD	76	
			190213	254		2001001	418		20017001NA	84		20020304BMD	77	
181103	444		190213	454		20011001AMD	75		20017001NE	84		20020304FUD	76	
181113	448		190214	256		20011001BLD	75		20017001RO	84		20020304NAD	76	
181113	559		190214	454		20011001FUD	75		20017001VE	84		20020304NED	76	
181120	447		190214	454		20011001NAD	75		20017001VI	84		20020304ROD	76	
181164	238		190214	466		20011001NED	75		20017401	240		20020304VED	76	
181164	453		190385	261		20011001ROD	75		20017401	426		20020304VID	76	
181164	465		190387	261		20011001VED	75		20017409	240		20020305	420	
1811649	238		190388	261		20011001VID	75		20017409	426		20020305ACD	79	
1811649	453		190547	245		20011002	418		20017409AC	86		20020305AMD	78	
1811649	465		190552	245		20011002AMD	75		20017409AM	86		20020305BLD	78	
181174	240		190647	245		20011002BLD	75		20017409BL	86		20020305BMD	79	
181174	453		190652	245		20011002FUD	75		20017409BM	86		20020305FUD	78	
181174	465		190970	247		20011002NAD	75		20017409FU	86		20020305NAD	78	
1811749	240		192445	533		20011002NED	75		20017409FU	86		20020305NED	78	
1811749	453		192445	553		20011002ROD	75		20017409NE	86		20020305ROD	78	
1811749	465		19250730	368		20011002VED	75		20017409RO	86		20020305VED	78	
181175	455		19250730	549		20011002VID	75		20017409VE	86		20020305VID	78	
181175	467		19260603	548		20012001	422		20017409VI	86		20020305VID	78	
18117705	451		19290603	548		20012001	422		20017409VI	86		20020306	419	
18118005	451		193123	268		20012001ACD	82		20017701	424		20020306ACD	77	
181191	273		193124	268		20012001AMD	82		20017702	282		20020306AMD	76	
181191	449		193223	268		20012001BLD	82		20018001	424		20020306BLD	76	
18119502	265		19417019	371		20012001BMD	82		20018002	282		20020306BMD	77	
18119502	339		19417029	371		20012001D	422		20018002	425		20020306FUD	76	
181200	447					20012001FUD	82		20018002AM	84		20020306NAD	76	
181200	539					20012001NAD	82		20018002BL	84		20020306NED	76	
181203	445		20010101	420		20012001NED	82		20018002FUD	84		20020306ROD	76	
181207	445		20010101	418		20012001ROD	82		20018002NA	84		20020306VED	76	
181217	445		20010101D	420		20012001VED	82		20018002NE	84		20020306VID	76	
181222	448		20010101D	418		20012001VID	82		20018002RO	84		20020501	421	
181222	558		20010102	419		20012002	422		20018002VE	84		20020501ACD	81	
181223	448		20010102	418		20012002ACD	82		20018002VI	84		20020501AMD	81	
181223	558		20010102D	419		20012002AMD	82		20018003	283		20020501BLD	81	
181224	447		20010102D	418		20012002BLD	82		20018004	283		20020501BMD	81	
181251	243		20010301	420		20012002BMD	82		20018005	282		20020501FUD	81	
181303	446		20010301	418		20012002D	422		20018005	425		20020501NAD	81	
181333	524		20010301ACD	74		20012002FUD	82		20018005AC	85		20020501NED	81	
181341	524		20010301ACD	79		20012002NAD	82		20018005BM	85		20020501ROD	81	
181385	257		20010301AMD	74		20012002NED	82		20018010	424		20020501VED	81	
181385	454		20010301AMD	78		20012002ROD	82		20018080	425		20020501VID	81	
181385	466		20010301BLD	74		20012002VED	82		20018201	335		20020502	421	
18138506	265		20010301BLD	78		20012002VID	82		20018201AC	233		20020502ACD	81	
18138506	339		20010301BMD	74		20013001	423		20018201AM	233		20020502AMD	81	
181403	446		20010301BMD	79		20013001	436		20018201BL	233		20020502BLD	81	
181436	522		20010301D	420		20013001	436		20018201FU	233		20020502BMD	81	
181437	529		20010301D	418		20016201	288		20018201NA	233		20020502FUD	81	
181438	529		20010301FUD	74		20016201	426		20018201NE	233		20020502NAD	81	
181468	449		20010301FUD	78		20016201AC	85		20018201RO	233		20020502NED	81	
181474	449		20010301NAD	74		20016203	288		20018201VE	233		20020502ROD	81	
181540	523		20010301NAD	78		20016203	426		20018201VI	233		20020502VED	81	
181703	446		20010301NED	74		20016203AC	85		20018301	337		20020502VID	81	
1818005	284		20010301NED	78		20016401	238		20019501	254		20020503	421	
18188005	451		20010301ROD	74		20016401	426		20019501	427		20020503ACD	81	
181903	444		20010301ROD	78		20016409	238		20019501AM	87		20020503AMD	81	
181920	447		20010301VED	74		20016409	426		20019501BL	87		20020503BLD	81	
183333	524		20010301VED	78		20016409AC	86		20019501FU	87		20020503BMD	81	
183341	524		20010301VID	74		20016409AM	85		20019501NA	87		20020503FUD	81	
183395	259		20010301VID	78		20016409BL	85		20019501NE	87		20020503NAD	81	
183398	264		20010302	419		20016409BM	86		20019501RO	87		20020503NED	81	
186103	444		20010302	418		20016409FU	85		20019501VE	87		20020503ROD	81	
186120	447		20010302ACD	74		20016409NA	85		20019501VI	87		20020503VED	81	
186203	445		20010302ACD	77		20016409NE	85		20020002	422		20020503VID	81	

LISTADO DE REFERENCIAS

Ref.	€	Pág.	Ref.	€	Pág.	Ref.	€	Pág.	Ref.	€	Pág.	Ref.	€	Pág.
200250504	421		20063604	348		20218003AC	31		20392001D	461		20517701	438	
200250504ACD	80		20063605	348		20218003AC	212		20410301	470		20517702	280	
200250504AMD	80		20063606	348		20218005	311		20410301D	470		20518001	438	
200250504BMD	80		20063607	348		20218006	30		20412001	470		20518001	438	
200250504BMLD	80		20063608	348		20218006B	212		20412001D	470		20518002	280	
200250504FUD	80		20063609	349		20218006BL	30		20416701	470		20518002	438	
200250504NAD	80		20063610	348		20218006NE	30		20417701	470		20518002	438	
200250504NED	80		20063611	348		20218007	32		20417701	471		20518003	281	
200250504ROD	80		20063612	348		20218080	311		20417702	285		20518003	439	
200250504VED	80		20063613	349		20218080	212		20418001	471		20518003	439	
200250504VID	80		20116701	194		20219101	29		20418002	285		20518004	281	
200250505	421		20117701	194		20219501	34		20418002	471		20518005	281	
200250505ACD	80		20117701	196		20219501BL	35		20418080	471		20518080	438	
200250505AMD	80		20117702	196		20219501NE	35		20419601	239		20518080	438	
200250505BLD	80		20117703	200		20220003	27		20419601	471		20518201	335	
200250505BMD	80		20117704	197		20220003	100		20419601	480		20518301	337	
200250505FUD	80		20118001	196		20220004	27		20419602	258		20520001	436	
200250505NAD	80		20118002	196		20220004	100		20419603	239		20520001	436	
200250505NED	80		20118003	199		20220004AC	27		20419603	472		20520001	538	
200250505ROD	80		20118004	200		20220004AC	100		20419603	480		20520001AC	101	
200250505VED	80		20118006	196		20224501	290		20438501	260		20520002	436	
200250505VID	80		20118007	197		20231201	35		20438501	473		20520002	436	
200250506	421		20119501	195		20238501	35		20438501	481		20520002	539	
200250506ACD	80		20210301	25		20238502	36		20438701	257		20520002AC	101	
200250506AMD	80		20210301ACD	26		20263604	344		20438701	473		20520040	436	
200250506BLD	80		20210301BLD	26		20263605	344		20438701	480		20520040	436	
200250506BMD	80		20210301D	25		20263607	344		20438702	255		20520041	436	
200250506FUD	80		20210301NED	26		20263608	344		20438702	472		20520041	436	
200250506NAD	80		20210302	24		20263609	344		20438703	257		20520041	538	
200250506NED	80		20210302D	24		20263611	344		20438703	472		20520041AC	101	
200250506ROD	80		20210303	25		20263612	344		20438703	480		20520070	436	
200250506VED	80		20210303ACD	26		20263613	344		20438704	255		20520070	436	
200250506VID	80		20210303BLD	26		20263901	230		20439501	255		20520071	436	
20022401	423		20210303NED	26		20263901AC	230		20510301	433		20520071	436	
20022401ACD	83		20210304	24		20266101	33		20510301	33		20520071	539	
20022401AMD	83		20210305	25		20266102	33		20510301D	433		20520071AC	101	
20022401BLD	83		20210305ACD	26		20298001	32		20510301D	433		20520501	434	
20022401BMD	83		20210305BLD	26		20310301	458		20510302	432		20520501	434	
20022401FUD	83		20210305NED	26		20310301D	458		20510302	432		20520502	434	
20022401NAD	83		20210306	24		20310303	458		20510302D	432		20520502	434	
20022401NED	83		20211001	27		20310303D	458		20510302D	432		20520503	434	
20022401ROD	83		20211001BLD	27		20312001	461		20510303	433		20520503	434	
20022401VED	83		20211001NED	27		20312001D	461		20510303	433		20522201	423	
20022401VID	83		20211002	27		20312003	461		20510304	432		20522201	437	
20024501	290		20211002BLD	27		20312003D	461		20510304	432		20522201	437	
20024501	391		20211002NED	27		20313001	462		20510305	433		20522201	558	
20024501	439		20212001	28		20316101	289		20510305	433		20522301	423	
20024501	439		20212001ACD	28		20316101	465		20510306	432		20522301	437	
20025001	242		20212001BLD	28		20316102	289		20510306	432		20522301	437	
20025002	243		20212001D	28		20316102	465		20511201	434		20522301	558	
20025003	243		20212001NED	28		20316701	463		20511201	434		20531201	262	
20025004	243		20212002	28		20317001	463		20511202	546		20531201	441	
20026010	422		20212002D	28		20317701	464		20511202	434		20531201	441	
20031201	262		20216101	33		20317702	283		20511202	434		20538501	254	
20031201	428		20216101AC	33		20318001	464		20511202	436		20538501	441	
20044001	522		20216102	33		20318002	284		20512001	436		20538501	441	
20044001AC	97		20216103	33		20318002	464		20512001	436		20539501	253	
20044001AM	97		20216103AC	33		20318003	284		20512001D	436		20539501	441	
20044001BL	97		20216104	33		20319101	274		20512001D	436		20539501	441	
20044001FU	97		20216409	34		20319101	463		20512002	436		20544001	523	
20044001NA	97		20216409AC	34		20320001	461		20512002	436		20544001AC	98	
20044001NE	97		20216409BL	34		20320002	461		20512002D	436		20544001BM	98	
20044001RO	97		20216409NE	34		20320301	459		20512002D	436		20547401	437	
20044001VE	97		20216701	28		20320301D	459		20516101	287		20547401	437	
20044001VI	97		20216701AC	28		20320701	459		20516101	439		20548601	521	
20044002	523		20216701BL	28		20320701D	459		20516101	439		20548601AC	97	
20044002AC	98		20216701NE	28		20321001	461		20516103	437		20548601BM	97	
20044002AM	98		20217001	29		20321701	459		20516103	439		20548701	528	
20044002BL	98		20217001AC	29		20321701D	459		20516103	439		20548701AC	100	
20044002BM	98		20217001BL	29		20322401	290		205164019	238		20548701BM	100	
20044002FU	98		20217001NE	29		20324501	291		205164019	440		20549501	252	
20044002NA	98		20217409	34		20324501	410		205164019	440		20560301	435	
20044002NE	98		20217409AC	34		20324501	426		20516701	437		20560301	435	
20044002RO	98		20217409BL	34		20324501	452		20516701	437		20560301	548	
20044002VE	98		20217409NE	34		20324501	465		20516801	437		20560302	435	
20044002VI	98		20217701	29		20326010	461		20516801	437		20560302	435	
20047501	322		20217702	29		20330301	460		20517001	437		20560302	548	
20050301	403		20217703	30		20340301	460		20517001	437		20625191	150	
20050301	422		20218001	29		20370301	460		205174019	240		20625199	148	
20050301	434		20218002	29		20390301	458		205174019	440		20625201	152	
20050301	434		20218003	31		20390301D	458		205174019	440		20625202	152	
20050301AC	82		20218003	212		20392001	461		20517701	438		20625203	153	



Ref.	€	Pág.	Ref.	€	Pág.	Ref.	€	Pág.	Ref.	€	Pág.	Ref.	€	Pág.
20625204	153		20735201BM	68		26115001	66		26218090	63		26290402ACD	58	
20625291	150		20735201TAM	68		26116209	66		26218099	65		26290402BMD	58	
20625299	148		20735201TBL	68		26116209AC	66		26220050	59		26290402TAMD	58	
20625301	157		20735201TFU	68		26116701	62		26220050AC	59		26290402TBLD	58	
20625302	157		20735201TNA	68		26116701AC	62		26220050BM	59		26290402TFUD	58	
20625391	150		20735201TNE	68		26116701BIM	62		26220050TAM	59		26290402TNAD	58	
20625399	149		20735201TRO	68		26116701ITAM	62		26220050TBL	59		26290402TNED	58	
20625491	150		20735201TVE	68		26116701ITBL	62		26220050TFU	59		26290402TROD	58	
20625499	149		20735201TVI	68		26116701ITFN	62		26220050TNA	59		26290402TVED	58	
20635191	151		20735202	69		26116701ITNE	62		26220050TNE	59		26290402TVID	58	
20635199	148		20735202	120		26116701ITRO	62		26220050TRO	59		26290403	58	
20635201	154		20735202AC	88		26116701ITRO	62		26220050TVI	59		26290403ACD	58	
20635202	154		20735202AM	88		26116701ITVE	62		26220050TVI	59		26290403BMD	58	
20635203	155		20735202BL	88		26116701ITVI	62		26220080	59		26290403TAMD	58	
20635204	156		20735202BM	88		26117001	62		26220080AC	59		26290403TBLD	58	
20635291	151		20735202FU	88		26117001AC	63		26220080BM	59		26290403TFUD	58	
20635299	148		20735202NA	88		26117001BIM	63		26220080TAM	59		26290403TNAD	58	
20635301	158		20735202NE	88		26117001TAM	63		26220080TBL	59		26290403TNED	58	
20635302	159		20735202RO	88		26117001TBL	63		26220080TFU	59		26290403TROD	58	
20635391	151		20735202VE	88		26117001TFU	63		26220080TNA	59		26290403TVED	58	
20635399	149		20735202VI	88		26117001TNA	63		26220080TNE	59		26290403TVID	58	
20635491	151		20735203	121		26117001TNE	63		26220080TRO	59		26298091	64	
20635499	149		20735204	122		26117001TRO	63		26220080TVE	59		26298091	213	
20718107	366		20735205	123		26117001TVE	63		26220080TVI	59		26298091AC	64	
20718201	163		20735206	125		26117001TVI	63		26222402	62		26298091BM	64	
20718201	204		20735207	126		26117209	66		26222402ACD	62		26298091TAM	64	
20718201	203		20735208	125		26117209AC	66		26222402BMD	62		26298091TBL	64	
20718202	149		20735209	124		26121001	67		26222402TAMD	62		26298091TFU	64	
20718202	111		20735210	121		26130701	54		26222402TBLD	62		26298091TNA	64	
20718202	233		20735211	122		26130701ACD	55		26222402TFUD	62		26298091TNE	64	
20719201	118		20735212	123		26130701BMD	55		26222402TNAD	62		26298091TRO	64	
20725191	112		20735291	113		26130701TAMD	55		26222402TNED	62		26298091TVE	64	
20725192	112		20735292	113		26130701TBLD	55		26222402TROD	62		26298091TVI	64	
20725199	110		20735299	110		26130701TFUD	55		26222402TVED	62				
20725201	114		20735301	138		26130701TNAD	55		26222402TVID	62				
20725202	36		20735302	138		26130701TNEO	55		26230701	56		29111351	325	
20725202	114		20735303	141		26130701TROD	55		26230701ACD	57		29933703	304	
20725202AC	37		20735304	141		26130701TVID	55		26230701BMD	57		29933703VL	304	
20725202AC	49		20735305	144		26130701TFUD	55		26230701TAMD	57		29943202	298	
20725202BL	37		20735306	145		26130801	54		26230701TBLD	57		29943203	298	
20725202BL	49		20735307	146		26130801ACD	55		26230701TFUD	57		29943204	299	
20725202NE	37		20735308	145		26130801BMD	55		26230701TNAD	57		29943205	298	
20725202NE	49		20735308AC	145		26130801TAMD	55		26230701TNED	57		29951501	331	
20725203	115		20735309	139		26130801TBLD	55		26230701TROD	57		29951502	331	
20725204	116		20735310	139		26130801TFUD	55		26230701TVED	57		29951503	331	
20725205	117		20735311	140		26130801TNAD	55		26230701TVID	57		29951504	232	
20725206	118		20735312	140		26130801TNED	55		26230801	56		29951505	232	
20725207	119		20735391	128		26130801TROD	55		26230801ACD	57		29951506	232	
20725208	116		20735392	128		26130801TVED	55		26230801BMD	57		29951507	232	
20725209	117		20735399	111		26130801TVID	55		26230801TAMD	57		29951607	265	
20725210	115		20735401	142		26190301	54		26230801TAMD	57		29952505	328	
20725291	112		20735402	144		26190301ACD	55		26230801TFUD	57		29953202	301	
20725292	112		20735403	142		26190301BMD	55		26230801TNAD	57		29953203	301	
20725299	110		20735404	143		26190301D	54		26230801TNED	57		29953204	300	
20725301	129		20735491	128		26190301TAMD	55		26230801TROD	57		29953205	301	
20725302	129		20735492	128		26190301TBLD	55		26230801TVED	57		29961001	374	
20725303	130		20735499	111		26190301TFUD	55		26230801TVID	57		29961002	374	
20725304	133		20739201	124		26190301TNAD	55		26231201	67		29961006	374	
20725305	136				26190301TNED	55		26290301	56		29961003	327		
20725305AC	136				26190301TROD	55		26290301ACD	57		29961105	326		
20725306	136		21018107	366		26190301TVED	55		26290301BMD	57		29963106	326	
20725307	137		21027301	205		26190301TVID	55		26290301D	56		29963107	327	
20725309	130		21027302	205		26212001	61		26290301TAMD	57		29963107	252	
20725311	131		21027303	206		26212001D	61		26290301TBLD	57		29963108	252	
20725312	132		21027304	206		26215001	66		26290301TFUD	57		29963108	325	
20725313	132		21027305	207		26217790	63		26290301TNAD	57		29963201	252	
20725391	127		21027306	208		26217792	63		26290301TNED	57		29963201	303	
20725392	127		21027307	209		26217793	64		26290301TROD	57		29963202	252	
20725399	111		21027308	207		26218003	65		26290301TVED	57		29963202	302	
20725401	134		21027309	208		26218003AC	66		26290301TVID	57		29963203	252	
20725402	133		21027310	209		26218003BM	66		26290401	58		29963203	302	
20725403	135		21027311	210		26218003TAM	66		26290401ACD	58		29963204	252	
20725404	135		21027312	210		26218003TBL	66		26290401BMD	58		29963204	303	
20725491	127		21027313	211		26218003TFU	66		26290401TAMD	58		29963205	303	
20725492	127		21027391	204		26218003TNA	66		26290401TBLD	58		29963206	302	
20725499	111		21027399	204		26218003TNE	66		26290401TFUD	58		29963211	302	
20735191	113				26218003TRO	66		26290401TNAD	58		29963212	303		
20735192	113				26218003TVE	66		26290401TNED	58		29963901	336		
20735199	110		26110501	60		26218003TVI	66		26290401TROD	58		29963902	304	
20735201	68		26110501AC	60		26218004	366		26290401TVED	58		29966310	252	
20735201	120		26112001	61		26218080	65		26290401TVID	58		29974802	374	
20735201AC	68		26112001D	61		26218080	213		26290402	58		29974802	326	



# CONDICIONES GENERALES DE VENTA

## Precios sin impuestos (sin IVA)

### Precios

Los precios de esta tarifa, y cualquier anexo que publiquemos, deben considerarse "precios de venta recomendados para el cliente final antes de impuestos".

Los precios están sujetos a cualquier variación según las circunstancias del mercado, materias primas, mano de obra, impuestos, etc., facturándose los que rijan el día de la expedición.

### Pedidos

Se considerarán condicionales y sujetos, por lo tanto, a nuestra consideración.

### Diseño

Nuestros modelos podrán ser modificados por exigencias de diseño, sin previo aviso, siempre en beneficio del artículo.

La documentación fotográfica y/o el diseño técnico reproducidos en los listados, catálogos, folletos y demás instrumentos publicitarios tienen valor indicativo, por lo que el cliente no podrá acogerse a ellos en caso de posibles quejas por disconformidad o diferencia con los productos suministrados. Las reclamaciones referentes a la falta de conformidad de los productos suministrados deberán realizarse, como máximo, en los quince días siguientes a la entrega de la mercancía en su lugar de destino.

### Plazo de entrega

Nuestros plazos de entrega son siempre aproximados y no nos hacemos responsables de las consecuencias de cualquier retraso.

### Expedición de productos

La mercancía viajará a PORTES PAGADOS SIEMPRE QUE EL PEDIDO NETO IMPORTE UN MÍNIMO DE 150€, si la compra es inferior a esta cantidad, viajará a portes pagados también pero realizaremos un cargo en la factura de 6€ en concepto de transporte y gestión. Para las islas, si el importe del pedido asciende a un mínimo de 600€, la mercancía viajará a portes pagados, si no, viajará siempre a portes debidos. Informamos que nuestro departamento de Logística gestiona los pedidos de forma independiente y no acumula los mismos para alcanzar el importe mencionado.

El destinatario, comprobada, al recibo de la mercancía, el estado de la misma, indicando en el albarán del transportista, las posibles incidencias.

### GARANTÍA

#### TRES COMERCIAL S.A.

Este producto está garantizado por TRES COMERCIAL S.A. ante eventuales defectos derivados del proceso de fabricación durante 2 años según la nueva Ley de Garantías aplicable desde Enero de 2007, con extensión voluntaria por parte de la firma de 3 años adicionales, totalizando 5 años a partir de la fecha de facturación.

• Excepcionando: acabados dorado, color, acerado, cobre, latón envejecido, cromo mate, madera y otros acabados especiales, por estar vinculados a la agresión externa según la dureza y calcificación de las aguas, así como complementos, griferías electrónicas, columnas y griferías termostáticas, que en estos casos será de 2 años.



• Nuestro servicio de asistencia técnica cubrirá las incidencias durante el periodo de 2 años de las griferías electrónicas y columnas, si la disfunción esta provocada por un fallo imputable al proceso productivo.

• Para ejercer los derechos que ofrece esta garantía, será imprescindible la presentación de la factura de compra.

• Queda excluido de esta garantía los daños producidos por uso inadecuado, montaje defectuoso, desgaste natural, medios de mantenimiento inadecuados.

• La eventual reparación o sustitución de componentes del producto afectado, no extiende la ampliación de la Garantía.

Una tarjeta con la garantía acompaña a cada modelo. Para que ésta garantía sea válida, es necesario en cada caso, la aceptación del defecto por nuestro departamento técnico. Nuestra garantía cubre únicamente la reposición del material sin cargo alguno, y sin que en ningún caso podamos hacernos responsables de los daños y perjuicios que por su defecto haya podido producirse directa o indirectamente, ni de los gastos de instalación.

### Pago

El importe de las facturas, salvo acuerdos especiales, será cancelado mediante giro SEPA B2B, como máximo, a 30 días fecha factura.

### Reserva de dominio

TRES comercial, S.A. será propietario de todos los productos suministrados al cliente, hasta el cobro completo de la factura correspondiente.

### Jurisdicción

La buena fe que preside las relaciones de TRES COMERCIAL, S.A. con todos sus clientes y nuestro deseo de resolver todas las divergencias por vía amistosa, no hacen pensar como posibles las reclamaciones judiciales. No obstante, se prevé este improbable caso, sometiéndose ambas partes a los tribunales de Barcelona con renuncia expresa a cualquier otro fuero.

### Aceptación condiciones

Todo pedido recibido, implica la aceptación formal de estas condiciones a menos de haber convenido otras por escrito.

## MUY IMPORTANTE

### Devoluciones

TRES no aceptará ninguna devolución de mercancía, sin que previamente nuestro Representante la haya aceptado y comunicado.

1) TRES NO ACEPTA NINGUNA DEVOLUCIÓN sin la aceptación previa. (La mercancía se devolverá al remitente)

2) TRES NO ACEPTA NINGUNA DEVOLUCIÓN de mercancía que pueda repararse con **Recambios Originales**.

3) TRES NO ACEPTA NINGUNA DEVOLUCIÓN de mercancía fuera de garantía.

4) No obstante, en caso de recepcionar mercancía perfectamente encajada, esta sufrirá una depreciación en factura de:

- Si es del año en curso	-15% depreciación
- Si es anterior a dos años	-30% depreciación
- Si es anterior a 3 años	-60% depreciación

Los envíos de mercaderías deberán efectuarse a portes pagados por el cliente.





Pinturas ecológicas libres de disolventes  
 PEDIDO ESPECIAL - Plazo de entrega 4 semanas



Blanco mate



Negro



Blanco



Ámbar



Naranja



Rojo



Violeta



Fucsia



Verde



Negro-cromo



Blanco-cromo



Ámbar-cromo



Naranja-cromo



Rojo-cromo



Violeta-cromo



Fucsia-cromo



Verde-cromo



Acero



Cobre



Latón viejo



Inox





Cromo





Anodizado



 Caja individual N°2 (200x150x80)  
Caja general de 8 unidades

 Caja individual N°3 (160x150x80)  
Caja general de 10 unidades

 Caja individual N°5 (300x160x80)  
Caja general de 5 unidades

 Caja individual N°9 (163x80x75)  
Caja general de 20 unidades

 Caja individual N°10 (132x83x60)  
Caja general de 30 unidades



Caja General  
(310x170x410)

 Caja individual N°6 (200x170x160)  
Caja general de 8 unidades

 Caja individual N°14  
Caja general de 3 unidades

 Caja individual N°11 (310x195x165)  
Caja general de 4 unidades





Caja General  
(345x405x330)

 Caja individual N°7 (310x195x105)  
Caja general de 6 unidades



Caja General  
(405x325x325)

 Caja individual N°1 (400x200x80)  
Caja general de 6 unidades

 Caja individual N°4 (400x120x80)  
Caja general de 10 unidades

 Caja individual N°8 (465x285x95)  
Caja general de 4 unidades

 Caja individual N°12  
Caja general de 2 unidades



Caja General  
(410x250x410)

 Caja individual N°13 (460x285x95)  
Caja general de 4 unidades



Caja General  
(475x294x398)

Caja individual para  
BARRA LUXUS (79x55x610)  
Caja general de 24 unidades

Caja individual para  
BARRA SUPRA (115x110x740)  
Caja general de 9 unidades

Caja individual para  
KIT BARRA-DUCHA (220x75x665)  
Caja general de 6 unidades



Caja General  
(355x380x750)



# Instalación recomendada.

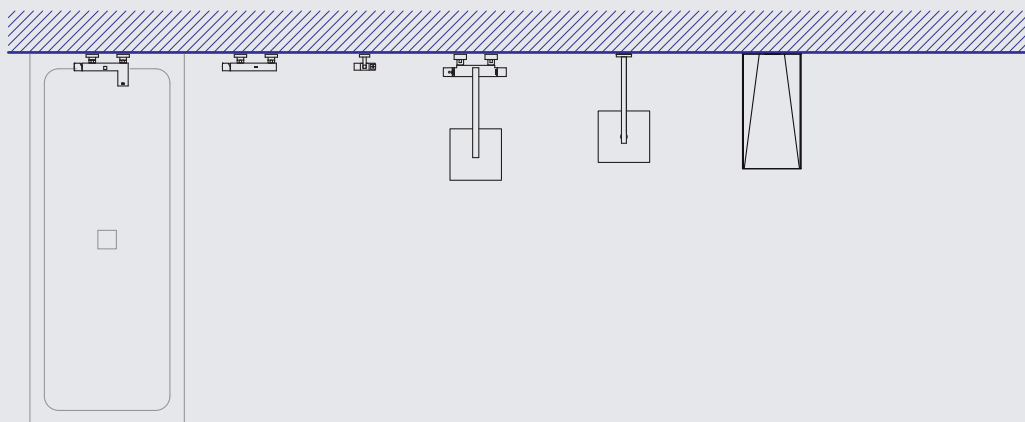
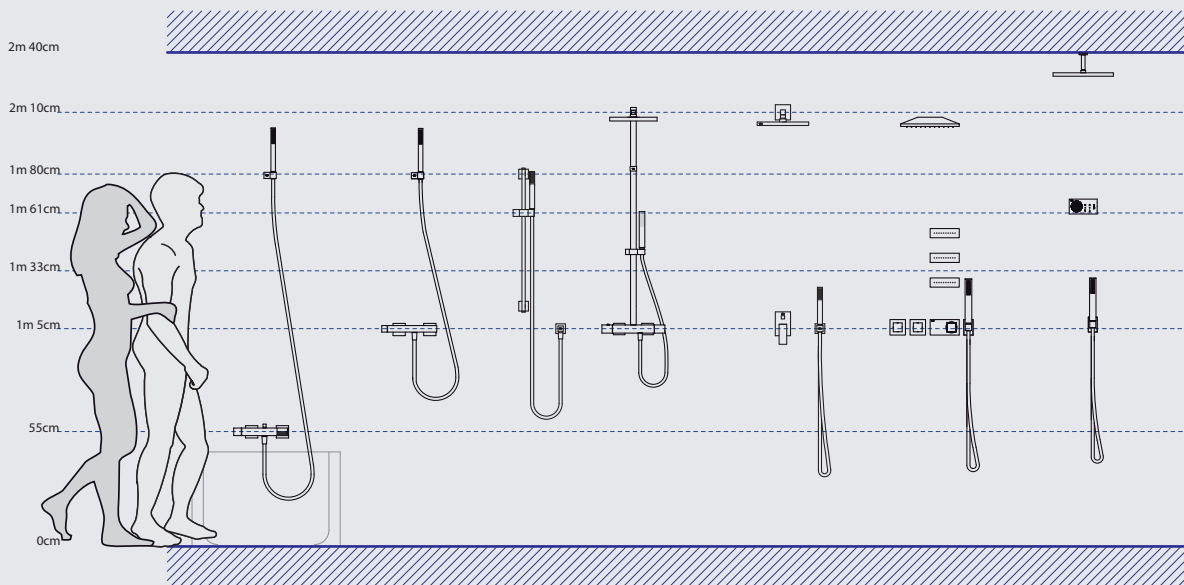



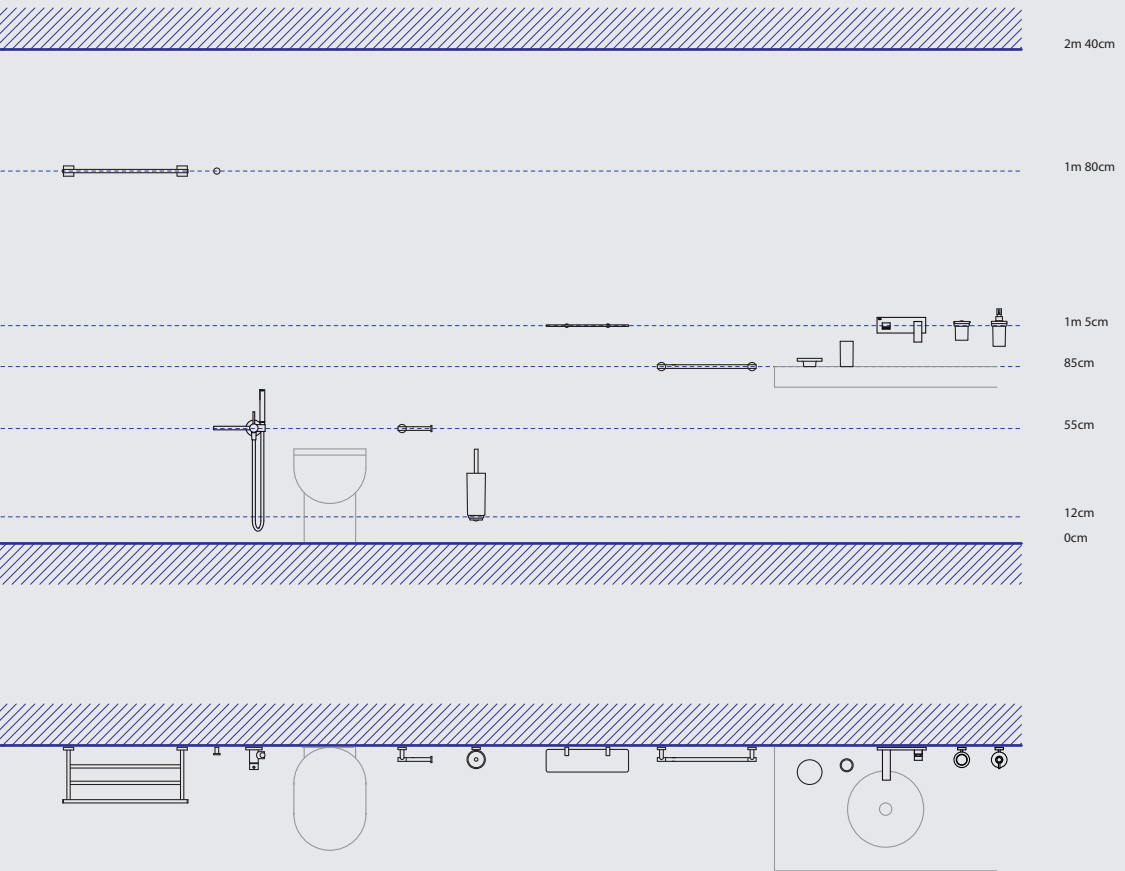

## INFORMACIONES

### Desagües ducha

En la ducha, se podrán utilizar dos salidas de agua al mismo tiempo siempre que el desagüe esté calculado para ello (Recomendamos el desagüe Ref.: 1.04.840).

### Suministro de agua

Diferentes productos necesitan distintas presiones con distintos caudales, pero con una presión dinámica de entre 2 y 3 bar sería suficiente. La presión dinámica se mide con el grifo abierto.

### Grifería empotrada

Estos productos empotrados tienen la gran ventaja de ganar espacio en duchas pequeñas y son más fáciles de limpiar.





# TRES

C/ Penedès, 16-26  
Zona Industrial, Sector A  
08759 VALLIRANA (Barcelona)

TEL. (34) 93 683 40 04  
FAX. (34) 93 683 50 61

Servicio de Atención al Cliente  
TEL. (34) 93 683 40 27  
comercialtres@tresgriferia.com

[www.tresgriferia.com](http://www.tresgriferia.com)



REF. 7342017010 / Ed. 01-2017